

# BAS J Series Programmer

INSTRUCTION MANUAL

---

Please read this manual before using the machine.  
Please keep this manual within easy reach for quick reference.

---

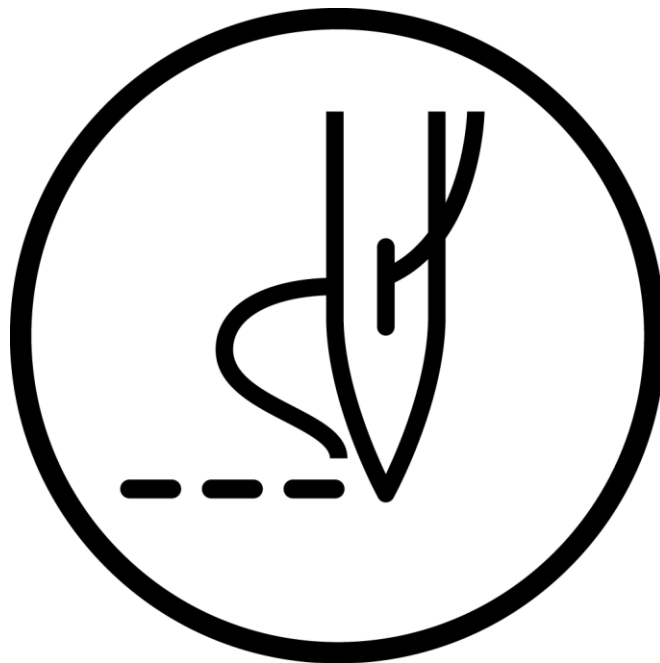

---

**brother**

Thank you very much for buying a BROTHER sewing machine. Before using your new machine, please read the safety instructions below and the explanations given in the instruction manual.

With industrial sewing machines, it is normal to carry out work while positioned directly in front of moving parts such as the needle and thread take-up lever, and consequently there is always a danger of injury that can be caused by these parts. Follow the instructions from training personnel and instructors regarding safe and correct operation before operating the machine so that you will know how to use it correctly.



# SAFETY INSTRUCTIONS

## [1] Safety indications and their meanings







This instruction manual and the indications and symbols that are used on the machine itself are provided in order to ensure safe operation of this machine and to prevent accidents and injury to yourself or other people.

The meanings of these indications and symbols are given below.

### Indications

 <b>WARNING</b>	The instructions which follow this term indicate situations where failure to follow the instructions could result in death or serious injury.
 <b>CAUTION</b>	The instructions which follow this term indicate situations where failure to follow the instructions may result in minor or moderate injury.

### Symbols

-  ..... This symbol (  ) indicates something that you should be careful of. The picture inside the triangle indicates the nature of the caution that must be taken.  
(For example, the symbol at left means “beware of injury”.)
-  ..... This symbol (  ) indicates something that you must not do.
-  ..... This symbol (  ) indicates something that you must do. The picture inside the circle indicates the nature of the thing that must be done.  
(For example, the symbol at left means “you must make the ground connection”.)

## [2] Notes on safety

# ⚠ WARNING

## Basic precautions



Do not disassemble or modify the programmer, otherwise it may cause fire or electric shocks or problems with correct operation.



Ask the place of purchase or a qualified technician to carry out any internal inspections, adjustments or repairs that may be required.

(Any problems with correct operation that occur as a result of the customer attempting to disassemble or modify the programmer will not be covered by the warranty.)



The bag that the programmer came in should be kept out of the reach of children or disposed of safely. Young children may risk suffocation if they place it over their head while playing with it.



Do not handle the programmer or connector for the sewing machine or the AC adapter with wet hands, otherwise it may cause electric shocks.



If the programmer is subjected to a strong force such as by being dropped or stepped on, it may become damaged.



If you continue to use the programmer while it is damaged, it may result in fire or electric shocks. If the programmer becomes damaged, immediately disconnect it from the sewing machine (or disconnect the AC adapter from the wall outlet) and contact the place of purchase or a qualified technician.



Do not insert objects such as screwdrivers into the AC adapter jack or the memory media slot, otherwise it may cause fire or electric shocks or problems with correct operation.



Disconnect the AC adapter from the wall outlet before disconnecting the AC adapter plug from the programmer, otherwise it may cause electric shocks or problems with correct operation.



## Installation



Do not use any AC adapter other than the one from Brother, otherwise it may cause fire or electric shocks or problems with correct operation.



Do not damage or process the connection cable for the sewing machine or the AC adapter cable, or place heavy objects such as furniture on top of them or bend or pull them with excessive force, otherwise it may cause fire or electric shocks or problems with correct operation.



When using the AC adapter, do not use any voltage other than the specified voltage, otherwise it may cause fire or electric shocks or problems with correct operation.



Be sure to use an AC adapter that complies with the safety standards in the country of use, otherwise it may cause fire or electric shocks or problems with correct operation.



## During use



If a foreign object gets inside the programmer, immediately disconnect it from the sewing machine (or disconnect the AC adapter from the wall outlet) and contact the place of purchase or a qualified technician. If you continue to use the programmer while there is a foreign object inside it, may result in fire or electric shocks or problems with correct operation.



Do not use the programmer if a problem is noticed such as smoke or a bad odor coming from the programmer, otherwise it may cause fire or electric shocks or problems with correct operation.



Immediately disconnect the programmer from the sewing machine (or disconnect the AC adapter from the wall outlet) and contact the place of purchase or a qualified technician.



Do not allow water or oil to get onto the programmer, otherwise it may cause fire or electric shocks or problems with correct operation.



If any liquids get onto the programmer, immediately disconnect it from the sewing machine (or disconnect the AC adapter from the contact the place of purchase or a qualified wall outlet) and technician.



(The programmer must never be repaired by the customer, as it can be extremely dangerous to do so.)



Do not insert objects such as screwdrivers into the SD card slot or the USB media port.

Otherwise it may cause fire or electric shocks or problems with correct operation.

## CAUTION

### Environmental requirements



Use the programmer and the sewing machine in an area which is free from sources of strong electrical noise such as electrical line noise or static electric noise.

Sources of strong electrical noise may cause problems with correct operation of the programmer and the sewing machine.



Any fluctuations in the power supply voltage should be within  $\pm 10\%$  of the rated voltage for the machine. Voltage fluctuations which are greater than this may cause problems with correct operation of the programmer and the sewing machine.



The power supply capacity should be greater than the requirements for the equipment's power consumption.

Insufficient power supply capacity may cause problems with correct operation of the programmer and the sewing machine.



The ambient temperature should be within the range of 5° C to 35° C during use and storage.

Temperatures which are lower or higher than this may cause problems with correct operation of the programmer and the sewing machine.



The relative humidity should be within the range of 45% to 85% during use and storage, and no dew formation should occur in any devices.

Excessively dry or humid environments and dew formation may cause problems with correct operation of the programmer and the sewing machine.



In the event of an electrical storm, turn off the power and disconnect the power cord from the wall outlet.

Lightning may cause problems with correct operation of the programmer and the sewing machine.

### Installation



Do not place the programmer on unstable surfaces such as unsteady tables or high shelves, otherwise it may tip over or fall down and cause injury.



Do not place heavy objects on top of the programmer, otherwise it may become unbalanced and tip over or fall down and cause injury.



Turn off the power switch before connecting and disconnecting the connector for the sewing machine, otherwise it may damage the programmer and the control box.



Be sure to disconnect the connector for the sewing machine when using the AC adapter, otherwise it may cause problems with correct operation of the programmer.



### During use



The programmer and the sewing machine should only be used by operators who have received proper training.



Be sure to wear protective goggles when using the sewing machine.

If goggles are not worn, there is the danger that if a needle breaks, parts of the broken needle may enter your eyes and injury may result.



If a problem occurs with the operation of the programmer or the sewing machine, contact the place of purchase or a qualified technician.

# Contents

## Chapter 1

<b>Read Me</b> .....	<b>1</b>
Contents and usage.....	2

## Chapter 2

<b>Setting Up Your Programmer</b> .....	<b>3</b>
Part names and functions .....	4
Features.....	5
Stitch length.....	5
Stitch count.....	5
Basic operation .....	5
When using the programmer alone .....	6
Precautions on disassembly, assembly, and part replacement.....	6
Handling media.....	7
Using SD cards and USB media .....	7

## Chapter 3

<b>Programming Patterns</b> .....	<b>9</b>
Foreword.....	10
Keys to be used.....	10
About the programming screen .....	11
Description of icons .....	12
Programming procedure .....	16
Creating a line .....	22
Creating a curve .....	22
Creating an arc.....	23
Creating a rectangle .....	23
Creating a circle.....	24
Creating a semicircle .....	25
Creating an ellipse.....	25
Creating needle drop data .....	26
Creating feed data .....	26
Creating basting data .....	26
Editing programs (Editing outlines) .....	29
Deleting an outline .....	29
Moving an outline .....	29
Copying an outline.....	30
Rotating an outline.....	30
Moving an outline symmetrically .....	31
Copying an outline symmetrically .....	32
Moving an outline by an offset.....	33
Copying an outline by an offset.....	33
Resizing an outline .....	34
Changing the line type of an outline .....	35
Adding and deleting backtack stitches for an outline .....	35
Switching the sewing start and end points for outlines .....	36
Changing the connection method for outlines	36
Combining outlines .....	37
Changing the sewing order for an outline .....	37

Editing programs (Editing outline component points).....	38
Deleting an outline component point.....	38
Moving an outline component point.....	39
Adding an outline component point .....	40
Changing curve shapes.....	40
Changing the attributes of outline component points .....	41
Separating an outline at a component point...	41
Editing programs (Editing sewing points) .....	42
Deleting a sewing point .....	42
Moving a sewing point .....	43
Adding a sewing point .....	44
Changing the attributes of sewing points .....	45
Separating an outline at a sewing point .....	46
Setting bar tacking at a sewing point.....	46
Adding and deleting codes at sewing points ..	47
Editing end codes .....	47
List of code settings.....	48
Checking programs .....	49
Checking each stitch .....	49
Moving to the start position.....	50
Measuring distances.....	50
Programming example .....	51
Programming for each stitch.....	51
Pattern with lines .....	52
Pattern with curves .....	53
Double stitch and multiple stitch.....	54
Continuous sewing with the work clamp in position after thread trimming (feed) .....	55
Basting.....	56
Symmetrical pattern.....	57
Programming while entering splits in different patterns .....	58
Zigzag stitch .....	59
Example of modified program .....	60
Resizing a pattern.....	61
Modifying a part of pattern.....	62
Deleting the first stitch to change the sewing start point to the second stitch.....	63
Moving the sewing start point.....	64
Adding a new sewing start point before the first stitch .....	65
Adding an escape point before the sewing start point .....	66
Modifying a pattern by moving a component point .....	67
Modifying a pattern by adding a component point .....	68
Modifying a pattern by deleting a component point .....	69
Moving the pattern in parallel .....	70
Deleting a part of data during programming...	71
Moving a part of a continuous program in parallel .....	72
Moving a part of a continuous program in parallel partially.....	73
Inserting a straight line into a pattern .....	74

<b>Chapter 4</b>	
<b>Extended Option Output (Program) .....</b>	<b>77</b>
Foreword .....	78
Function of the extended option output .....	78
Description of icons .....	78
Setting extended option output .....	80
Opening the extended option output setting screen .....	80
Setting details of the extended option output .....	80
Setting enabling conditions .....	81
Saving extended option output .....	81
Saving with a different filename .....	82
Loading extended option output which has been created .....	83
Deleting extended option output .....	83
Applying extended option output to the sewing machine .....	84
Applying extended option output to the sewing machine .....	84
Displaying extended option output .....	84
Initializing extended option output .....	84
Table of condition number .....	85
Mode for operating the sewing machine .....	85
Standard input .....	85
Standard output .....	85
External input of the extended option .....	86
Extended option output .....	86
Table of extended option input .....	87
Table of extended option output .....	88
Examples of the extended option output .....	89
Use of extended option output (Basics) .....	92
Necessary items .....	92
Simplified examples of the extended option output .....	92
Use of extended option output (Application) .....	98
Necessary items (other than for Basics) .....	98
Limitations of extended option output .....	98
Examples of option outputs (Application) .....	99
How to create programs .....	104
Use of extended option output (Reference material) .....	106
Parts for the extended option .....	106
Circuit diagram of the checking board .....	107
Block diagram .....	108

<b>Chapter 5</b>	
<b>File Manager Functions .....</b>	<b>109</b>
Foreword .....	110
Tasks that can be carried out using the File Manager .....	110
Description of icons .....	110
Displaying file lists .....	113
Checking file information .....	113
Changing the content display method to list format or icon format .....	113
Sorting the display (applying sorting conditions) .....	114
File operations .....	115
Deleting files and folders .....	115
Copying files and folders .....	116
Moving files and folders .....	117
Changing the names of files and folders .....	118
Creating folders .....	119
File operations using storage media ..	120
Importing files from storage media into the panel internal memory .....	120
Exporting files from the panel internal memory to storage media .....	120
Formatting media .....	121
<b>Chapter 6</b>	
<b>Setting Functions .....</b>	<b>123</b>
Setting the programming functions .....	124
Setting the display .....	125
Setting the date and time .....	126
List of time zone settings .....	127
Setting the language .....	128
Setting the sound .....	128
Checking information .....	129
Viewing information .....	129
Updating the software .....	130
Checking the software license .....	130





# **Chapter 1**

## **Read Me**

## Contents and usage

This document is organized as follows.

**Chapter 1 Read Me**

Describes general precautions.

**Chapter 2 Setting Up Your Programmer**

Describes how to set up your programmer and its basic operations.

**Chapter 3 Programming Patterns**

Describes how to create programs with icons.

**Chapter 4 Extended Option Output**

Describes how to set the extended option output.

**Chapter 5 File Manager Functions**

Describes how to check, copy, move, and change program data.

**Chapter 6 Setting Functions**

Describes how to display program of the sewing machine.

# **Chapter 2**

## **Setting Up Your Programmer**

Part names and functions

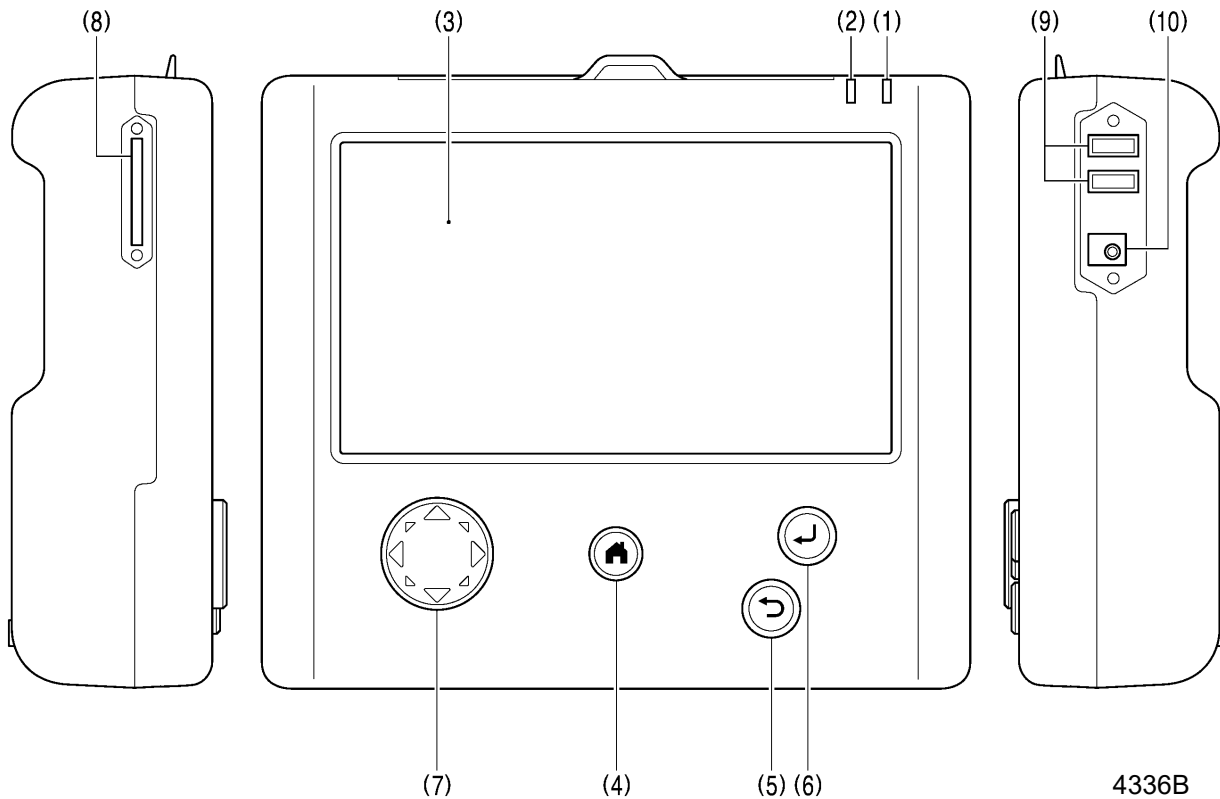

4336B

(1) Power indicator	Illuminates when the power is turned on.
(2) Caution indicator	Illuminates when an error occurs.
(3) LCD/touch panel	This displays messages and touch keys (icons).
(4) HOME key	This key is used to return to the home screen. At the home screen, hold down (for 2 seconds or more) to switch to sleep mode*.
(5) BACK key	This key is used for operations such as returning to the previous step and canceling settings.
(6) ENTER key	This key is used for operations such as confirming settings.
(7) JOG key	This key is used when programming sewing data.
(8) SD card slot	Insert an SD card.
(9) USB port×2	Connect a device such as USB media.
(10) AC adapter jack	Connect an AC adapter.

\* The screen will turn off and the sewing machine cannot be operated. Press the home key once more to cancel sleep mode.

## Features

### Stitch length

Setting is possible within a range of 0.3 to 20.0 m.









### Stitch count

A single program can contain a maximum of 20,000 stitches.





(The sewing machine can hold 999 patterns, and the storage media can hold as many patterns as the upper limit of the media's storage capacity allows. However, if there are some patterns which have a large number of stitches in each program, the number of patterns which can be stored may be less.)

## Basic operation

### WARNING

- |  |  |
|--|--|
| <p> Do not handle the programmer or connector for the sewing machine or the AC adapter with wet hands, otherwise it may cause electric shocks.</p>  | <p> Disconnect the AC adapter from the wall outlet before disconnecting the AC adapter plug from the programmer, otherwise it may cause electric shocks or problems with correct operation.</p>   |
| <p> Do not insert objects such as screwdrivers into the AC adapter jack or the memory media slot, otherwise it may cause fire or electric shocks or problems with correct operation.</p>  | <p> Do not damage or process the connection cable for the sewing machine or the AC adapter cable, or place heavy objects such as furniture on top of them or bend or pull them with excessive force, otherwise it may cause fire or electric shocks or problems with correct operation.</p>   |
| <p> Do not use any AC adapter other than the one from Brother, otherwise it may cause fire or electric shocks or problems with correct operation.</p>  | <p> Do not use the programmer if a problem is noticed such as smoke or a bad odor coming from the programmer, otherwise it may cause fire or electric shocks or problems with correct operation. Immediately disconnect the programmer from the sewing machine (or disconnect the AC adapter from the wall outlet) and contact the place of purchase or a qualified technician. (The programmer must never be repaired by the customer, as it can be extremely dangerous to do so.)</p> |
| <p> When using the AC adapter, do not use any voltage other than the specified voltage, otherwise it may cause fire or electric shocks or problems with correct operation.</p>  |  |
| <p> If a foreign object gets inside the programmer, immediately disconnect it from the sewing machine (or disconnect the AC adapter from the wall outlet) and contact the place of purchase or a qualified technician. If you continue to use the programmer while there is a foreign object inside it, may result in fire or electric shocks or problems with correct operation.</p> |  |

### CAUTION

- |   |  |
|---|--|
| <p> Do not place the programmer on unstable surfaces such as unsteady tables or high shelves, otherwise it may tip over or fall down and cause injury.</p> | <p> Turn off the power switch before connecting and disconnecting the connector for the sewing machine, otherwise it may damage the programmer and the control box.</p> |
| <p> Do not place heavy objects on top of the programmer, otherwise it may become unbalanced and tip over or fall down and cause injury.</p>                | <p> Be sure to disconnect the connector for the sewing machine when using the AC adapter, otherwise it may cause problems with correct operation of the programmer.</p> |
| <p> The programmer and the sewing machine should only be used by operators who have received proper training.</p>  |  |

When using the programmer alone

**! WARNING**

 Be sure to use an AC adapter that complies with the safety standards in the country of use. Otherwise, it may cause fire or electric shocks or problems with correct operation.



Purchase an AC adaptor conforming to the specifications below.

OUTPUT: 24 VDC, 0.5A

Polarity: 

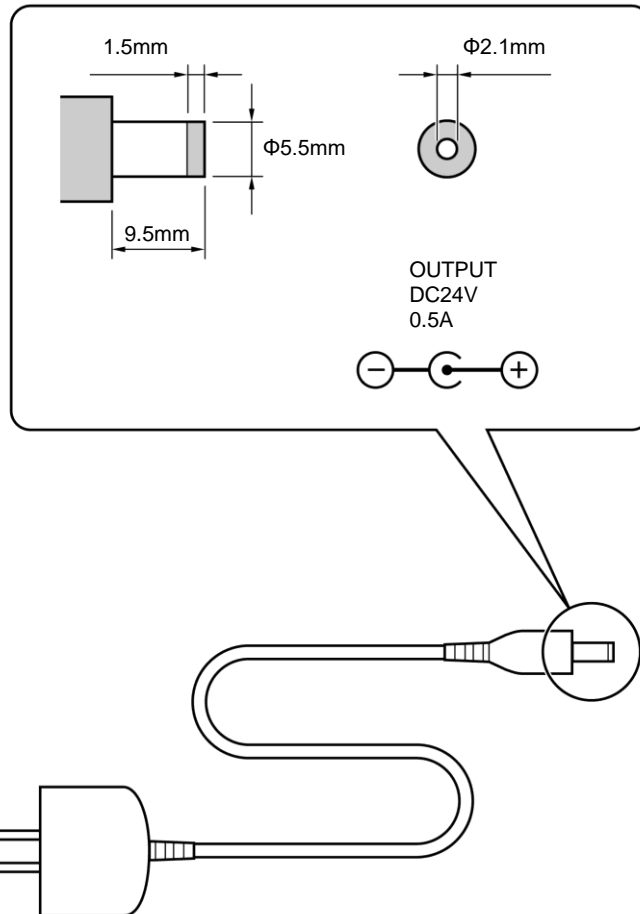

3670B  
3671B

Precautions on disassembly, assembly, and part replacement

**! WARNING**

 Do not disassemble or modify the programmer, otherwise it may cause fire or electric shocks or problems with correct operation. Ask the place of purchase or a qualified technician to carry out any internal inspections, adjustments or repairs that may be required.

 (Any problems with correct operation that occur as a result of the customer attempting to disassemble or modify the programmer will not be covered by the warranty.)

- For preventing the internal wiring from being damaged, considerable care must be taken when assembling and disassembling the case.
- For preventing the internal wiring from getting caught in the case or other parts, care must be taken when assembling the case.
- Be sure to use a torque of 0.5 N/m when tightening screws. Using excessive torque may damage the case.

## Handling media

### ! WARNING



Do not insert objects such as screwdrivers into the SD card slot or the USB media port. Otherwise it may cause fire or electric shocks or problems with correct operation.

## Using SD cards and USB media

### ■ Configuration of SD card and USB media folders

Data type	Folder name	File name
Control program	¥BROTHER¥ISM¥ISMSYS¥	ISM39MN.BVP (Main control program) ISM39MT.BVP (Motor control program) ISM42PL.BVP (Panel control program)
Sewing data	¥BROTHER¥ISM¥ISMDJ**¥  * "" represents the value for memory switch No. 752. If you would like to keep additional sewing data for different sewing machines on a single SD card, change the folder name.	ISMS0***.SEW ISMS0***.EMB * "" represents the sewing data number.
Memory switch	Same as above	memorysw.db
Parameter	Same as above	userparam.db
Cycle program	Same as above	ISMCYC**.SEW * "" represents the sewing data number.
Extended option programs	Same as above	ISMSEQ**.SEQ * "" represents the sewing data number.
Error log	¥BROTHER¥ISM¥ISMLDT¥	Stores the files which relate to error logs.

### ■ Notes on handling SD cards and USB media

- Do not insert any objects into the card slot and the USB media port other than SD cards or USB media. Otherwise, damage to the product may occur.
- Do not remove the power plug or insert or remove an SD card or USB media while data reading or writing operations are in progress. Otherwise the data may become corrupted or the SD card or USB media may become damaged.
- If the data cannot be recognized, return the data to the device which recorded it or some other similar device to check if the SD card or USB media is damaged or not.
- The data on the SD card or USB media may become lost or corrupted due to some malfunction or accident. It is recommended that you make backups of important data.



\* Company names and product names appearing in this manual are trademarks or registered trademarks of the respective owners.

\* This product is compatible with media that has been formatted using the FAT16/32 method. Media that has been formatted using other formatting methods cannot be used.

## CHAPTER 2 SETTING UP YOUR PROGRAMMER

### ■ Inserting SD cards and USB media

1. Open the media slot cover.
2. Insert the SD card or USB media into the SD card slot or USB media port of the programmer.  
The programmer is compatible with the following SD cards and USB media.

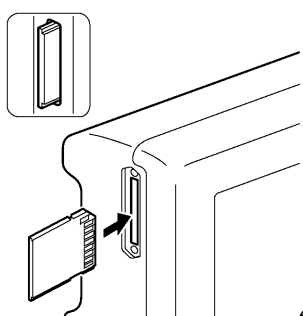
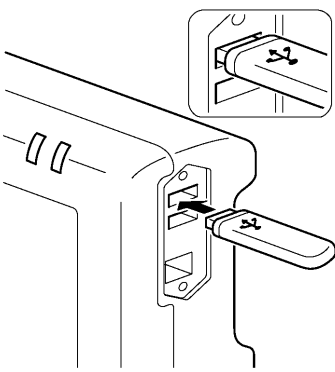
Type	Setting location
 <ul style="list-style-type: none"><li>• SD cards (maximum capacity 2 GB)</li><li>• SDHC cards (maximum capacity 32 GB)</li></ul>  3594B	 4290B
<ul style="list-style-type: none"><li>• USB media (maximum capacity 32 GB)</li></ul>	 3597B

### ■ When removing SD cards and USB media

Check that reading or writing has finished, and then simply remove the storage device.

If the programmer is connected to a PC, first wait until the SD card or the USB media is no longer being accessed by the PC, and then remove the SD card or USB media.



# **Chapter 3**

## **Programming Patterns**

# Foreword

While being operated by the programmer, a number of icons are displayed on the screen which illustrate its operations and functions. This chapter describes the procedure for programming with icons.

## Keys to be used

Below is an explanation of the keys which are used when programming.

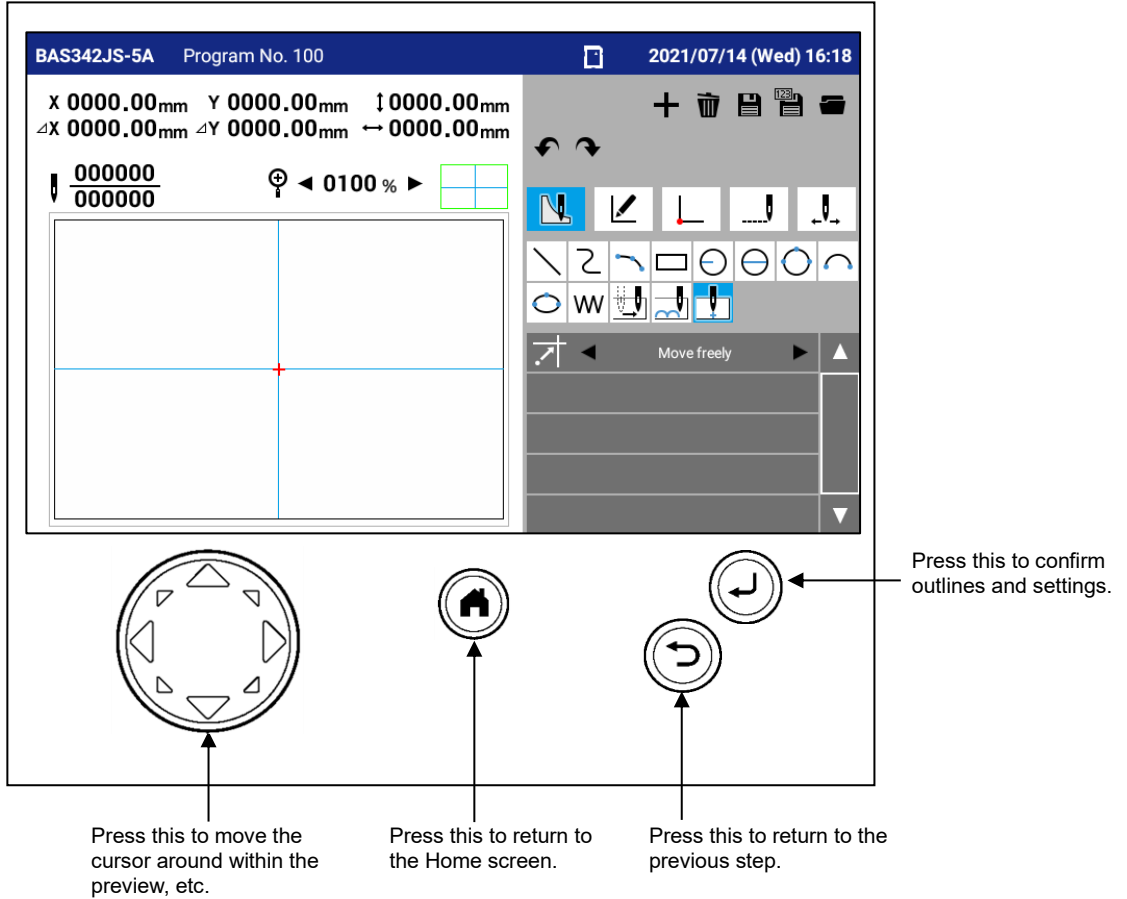

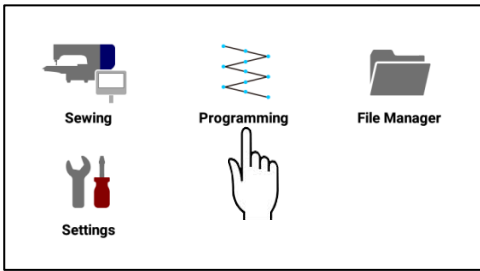

## About the programming screen

At the Home screen, touch  to display the programming screen.



\* When "Starting extended option editing directly" in "Programmer" is set to "ON", touch  in the Home screen to display the extended option output setting screen. Follow the procedure below to display the programmer screen from the extended option output setting screen. Refer to Chapter 6 for details on changing the setting.

1. At the extended option output setting screen, touch .
2. A dialog box will be displayed for you to select the type of file to create.
3. Select "New Sewing Program", and then touch .

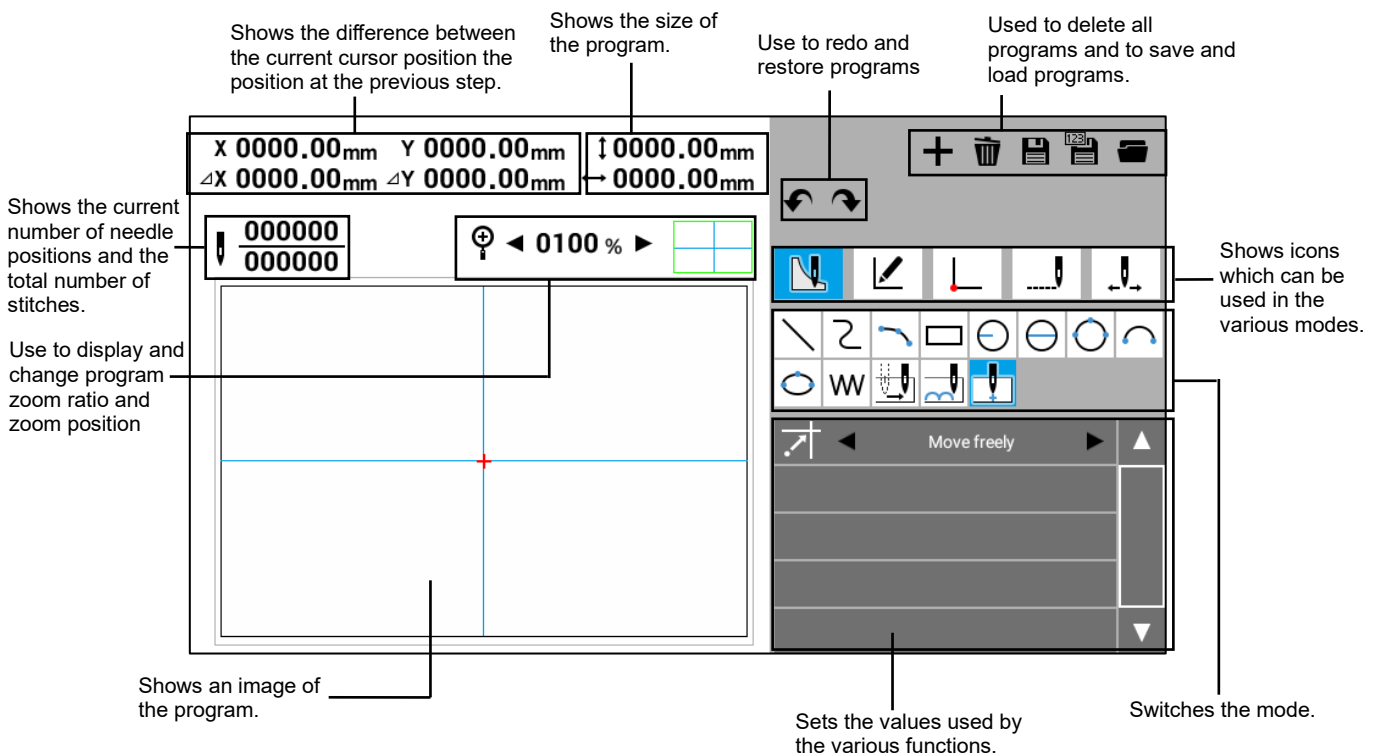















## Description of icons

---























### Programming

---









		Creating a line	
		Creating a curve	
		Creating an arc	
		Creating a rectangle	
		Creating a circle of the specified radius (clockwise or counterclockwise)	
		Creating a circle of the specified diameter (clockwise or counterclockwise)	
	Creating data		Creating a circle by specifying three points
			Creating a semicircle
			Creating an ellipse
			Creating needle drop data
			Creating feed data
			Creating basting data
			Specifying the sewing start point

---





Editing programs

 Editing outlines	 Deleting an outline
	 Moving an outline
	 Copying an outline
	 Rotating an outline
	 Moving an outline symmetrically
	 Copying an outline symmetrically
	 Moving an outline by an offset
	 Copying an outline by an offset
	 Resizing an outline
	 Changing the line type of an outline
	 Adding and deleting backtack stitches for an outline
	 Switching the sewing start and end points for outlines
	 Changing the connection method for an outline
	 Combining outlines
	 Changing the sewing order for an outline
 Editing outline component points	 Deleting an outline component point
	 Moving an outline component point
	 Adding an outline component point
	 Changing curve shapes
	 Changing the attributes of outline component points
	 Separating an outline at a component point





## CHAPTER 3 PROGRAMMING PATTERNS

 Editing sewing points	 Deleting a sewing point
	 Moving a sewing point
	 Adding a sewing point
	 Changing the attributes of sewing points
	 Separating an outline at a sewing point
	 Setting bar tacking at a sewing point
	<b>CODE</b> Adding and deleting codes at sewing points
	<b>END</b>  Editing end codes



### Checking programs

 Checking	 Moving backward one stitch at a time
	 Moving forward one stitch at a time
	 Moving to the start position
	 Measuring distances

**Buttons for running external functions**

	Creating a new file
	Deleting all changes to the program being edited
	Saving
	Saving with a different filename
	Opening a file

**Other**

	Undoing changes
	Redoing changes

## Programming procedure

The procedure for programming with icons is as follows.

■ **1. Displaying the programming screen**

At the Home screen, touch  .

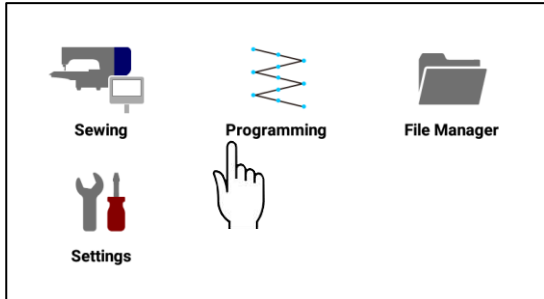

The programming screen will be displayed.

◆ If you press **Yes** when the following message is displayed, the sewing machine will operate and programs can then be created.

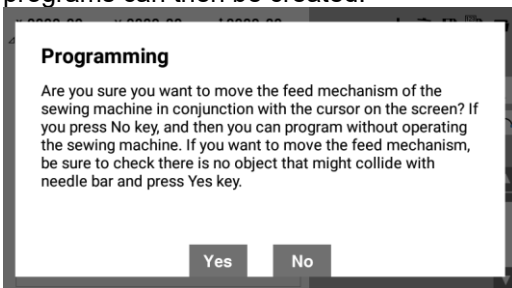

Furthermore, if you press **No** at the above screen, the model selection screen (shown below) will be displayed, so select the applicable model and then touch **OK** . At this time, you can create programs without operating the sewing machine.

Touch **Cancel** to return to the Home screen.

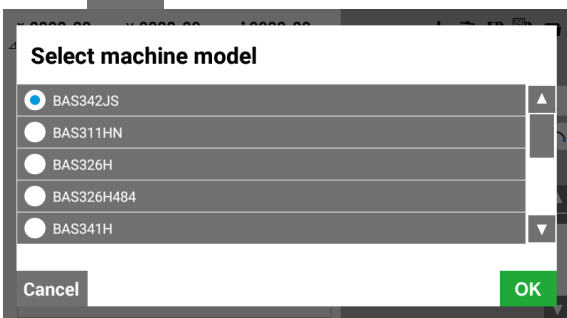

◆ If the following message is displayed, press **Yes** to start again from the program which was not saved when operation was last stopped. In addition, press **No** to start creating a new program.





■ 2. Starting program creation

Touch .

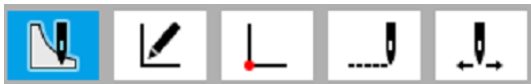

■ 3. Set the sewing start position.

1. Touch .

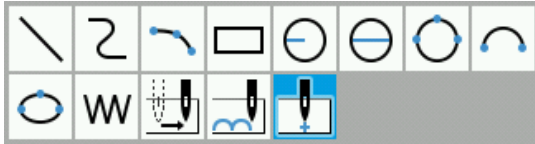

2. Use the jog key to move the cursor in the + direction.

3. Once you have set the sewing start position, press .

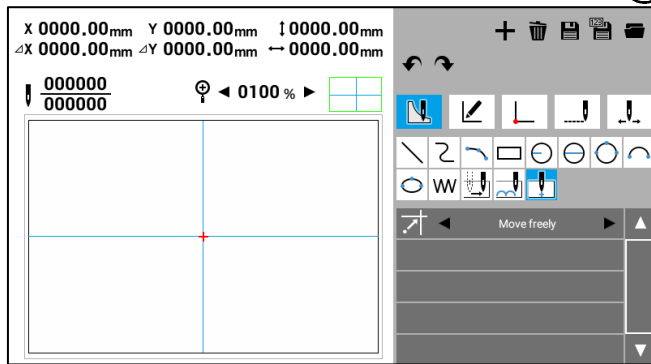

■ 4. Creating program

Select the desired icon from the icons in the top-right corner of the screen, and then create a program for the design you would like to sew. The programs you create are enabled until you delete them.

For detailed explanations on creating programs, refer to "Creating programs" (page 22) and "Programming example" (page 51).

## CHAPTER 3 PROGRAMMING PATTERNS

### ■ 5. Inputting an end code

Once you have finished creating the program, edit the end code that controls the sewing machine operation. The following six end codes from 111 to 116 are available, each of which carries out machine operations as shown in the table below.

When creating programs, an end point (normal) is set at the sewing end point.

111	Normal
112	Fixes the sewing speed at 1200 sti/min or lower
113	Carrying out no thread wiping
114	Fixes the sewing speed at 1200 sti/min or lower and no thread wiping is carried out
115	Carrying out no thread trimming
116	Fixes the sewing speed at 1500 sti/min or lower

1. Touch .



2. Touch **END** .



3. Touch the end code that you would like to set, and then change the code.

<input checked="" type="checkbox"/>	111: Normal
<input type="checkbox"/>	112: Under 1200sti/min
<input type="checkbox"/>	113: Disable Wiper
<input type="checkbox"/>	114: Disable Wiper, Under 1200sti/min
<input type="checkbox"/>	115: Disable Trimming
<input type="checkbox"/>	116: Under 1500sti/min

■ 6. Saving the created program

For details on the operation method, refer to "File Manager Functions" (page 112).

1. Touch .



[When saving a new program]

2. Touch the Program No. field to display the numeric keypad screen, and then touch the keys to enter the program number.

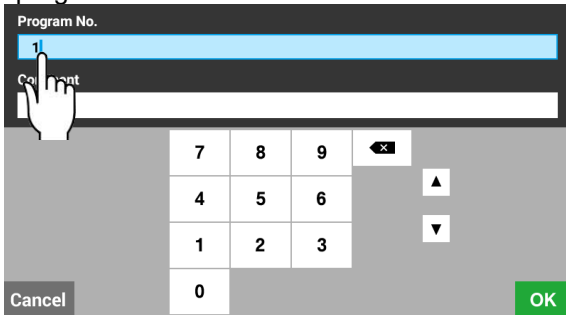

3. Touch the Comment field to display the keyboard screen, and then touch the keys to enter a comment.

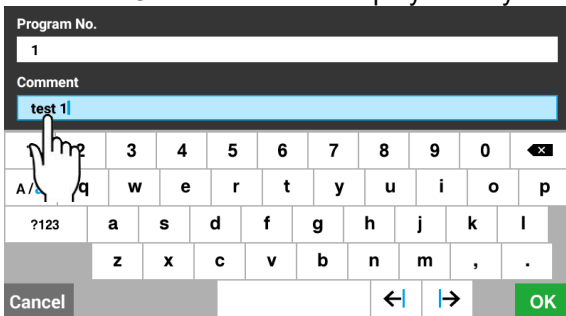

4. When you touch **OK** on the numeric keypad screen or the keyboard screen, the file will be saved in the panel internal memory and the display will return to the programming screen. Touch **Cancel** to return to the programming screen without saving the file.

[When overwriting an existing program number]

2. The program saving dialog screen will be displayed, so touch **Yes** to overwrite the existing file. Touch **No** to return to the programming screen.

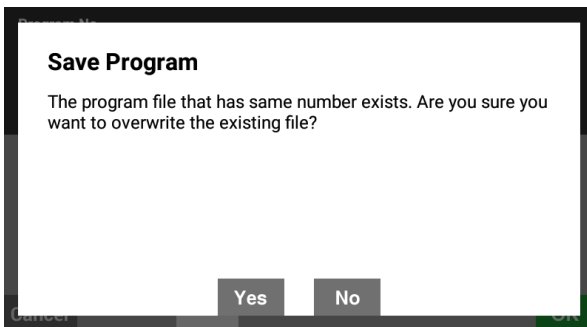

## CHAPTER 3 PROGRAMMING PATTERNS

### ■ 7. Saving programs with a different name

1. Touch .



2. Touch the Program No. field to display the numeric keypad screen, and then touch the keys to enter the program number.

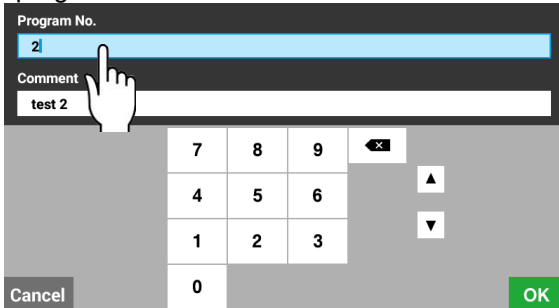

3. Touch the Comment field to display the keyboard screen, and then touch the keys to enter a comment.

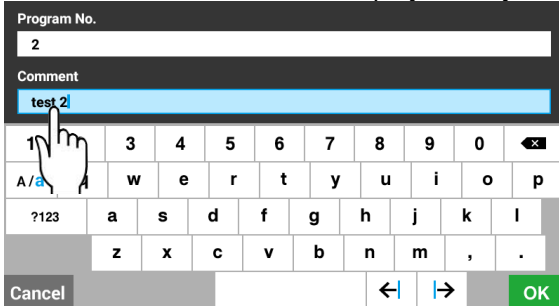

4. When you touch **OK** on the numeric keypad screen or the keyboard screen, the file will be saved in the panel internal memory and the display will return to the programming screen. Touch **Cancel** to return to the programming screen without saving the file.

### ■ 8. Ending programming

1. Press  at the programming screen. (The display will return to the Home screen.)
2. If a program is currently being created, the following dialog screen will be displayed.  
Touch **Yes** to discard the program which has been completed and end programming.  
Touch **No** to return to the programming screen.

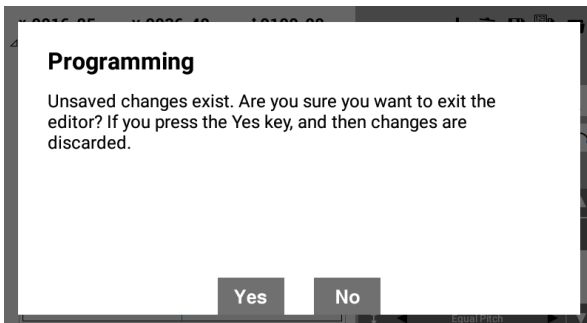

■ **9. Loading programs which have already been created**

For details on the operation method, refer to "File Manager Functions" (page 112).

1. Touch .



◆ If there is a program which is currently being created, the following dialog screen will be displayed. Select either "Overwrite current data", "Append to the current data" or "Append to the current data (Split Auto Insert)", and then touch **OK**. Refer to the following for details on each selection item.

Selection item	Operation
Overwrite current data	Discard the data which is currently being created, and display the data which has been loaded.
Append to the current data	The data is connected via feeding to the end of the program which is currently being edited.
Append to the current data (Split Auto Insert)	The data is connected via feeding to the end of the program which is currently being edited, and a code (split) is inserted at the beginning of the loaded data.

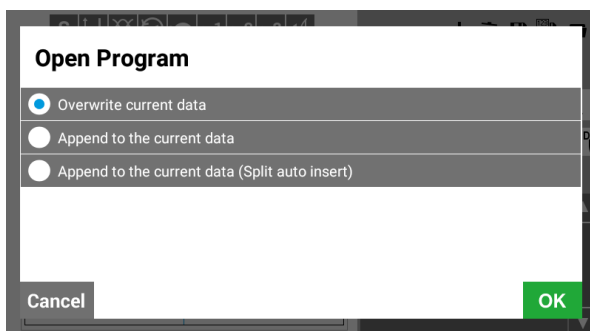

2. Touch  to select the media to load the file from, and then navigate to the folder to load the file from.

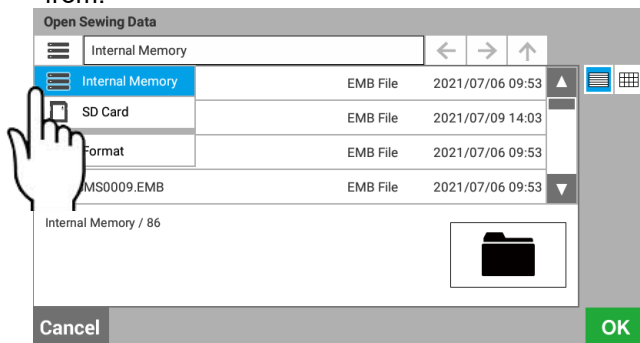

3. Select the file to be loaded from the file list, and then touch **OK**.

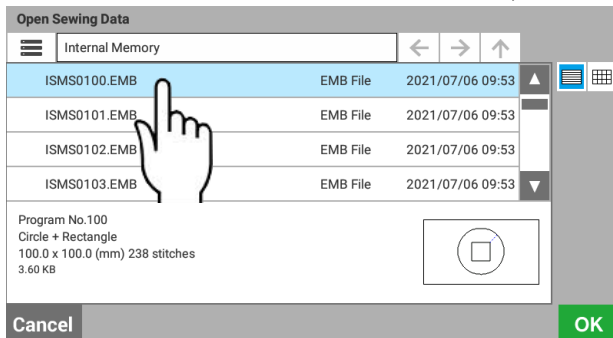

4. The details of the file which have been loaded will appear in the programming screen.

## CHAPTER 3 PROGRAMMING PATTERNS

### ■ 10. Deleting programs

1. Touch .

2. The program which is currently being edited will be deleted and the display will return to the initial status.



## Creating programs

This section describes icons used for creating and editing program and how to use them.

\* For details about operations, refer to "Programming example" (page 51).

\* For details on the setting method for zigzag stitches, refer to "Zigzag stitch" (page 59).

\* In the program, ● indicates the sewing start point and × indicates the sewing end point.

### \ Creating a line

1. Touch .



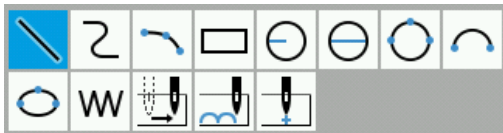

2. Touch .



3. Make the settings for each item.

\* Refer to "Setting parameters" (page 27) for details on the setting method.

4. Use the jog key to move the cursor + to the next point, and then press .

5. Repeat step 4 until the shape you would like to sew has been created. Move the cursor + to the end point, and then press  twice.

\* You can connect straight lines, curves and arcs together.

### ~ Creating a curve

1. Touch .



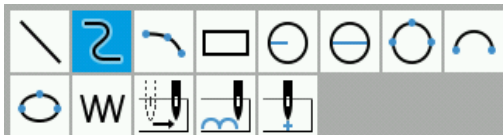

2. Touch .



3. Make the settings for each item.

\* Refer to "Setting parameters" (page 27) for details on the setting method.

4. Use the jog key to move the cursor + to the next point, and then press .

5. Repeat step 4 until the shape you would like to sew has been created. Move the cursor + to the end point, and then press  twice.



 **Creating an arc**

1. Touch .

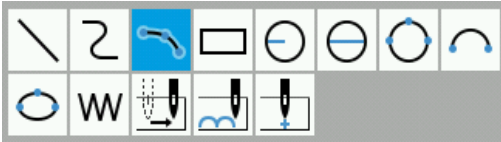

2. Touch .



3. Make the settings for each item.
  - \* Refer to "Setting parameters" (page 27) for details on the setting method.
4. Use the jog key to move the cursor **+** to the second point, and then press .
5. Use the jog key to move the cursor **+** to the third point, and then press .
- \* If you would like to create more than three points for the arc, you can continue entering more points.

 **Creating a rectangle**

1. Touch .



2. Touch .

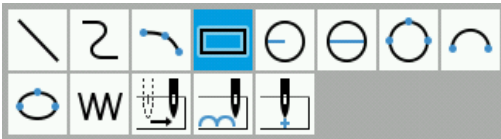

4. Use the jog key to move the cursor **+** to the second point, and then press .

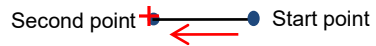

5. Use the jog key to set the rectangle shape. To create the rectangle shape, move the cursor **+** from the single side which was created in step 4 to the desired position for the rectangle, and then press .

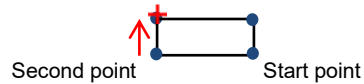

3. Make the settings for each item.
 

- \* Refer to "Setting parameters" (page 27) for details on the setting method.

## CHAPTER 3 PROGRAMMING PATTERNS

### Creating a circle

The following three options are available for creating a circle.

 Specify a radius to create a circle (clockwise or counterclockwise)

 Specify a diameter to create a circle (clockwise or counterclockwise)

1. Touch .



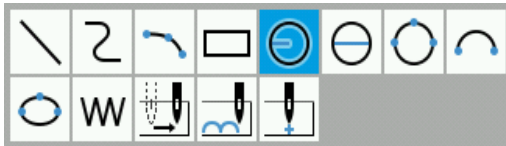

#### ■ If is selected

2. Touch  or .



3. Make the settings for each item.

\* Refer to "Setting parameters" (page 27) for details on the setting method.

4. Use the jog key to move the cursor  to the second point, and then press .



#### ■ If is selected

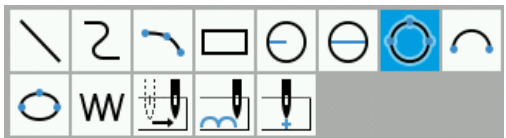

2. Touch .



3. Make the settings for each item.

\* Refer to "Setting parameters" (page 27) for details on the setting method.

4. Use the jog key to move the cursor  to the second point, and then press .

5. Use the jog key to move the cursor  to the third point, and then press .





### Creating a semicircle

1. Touch .

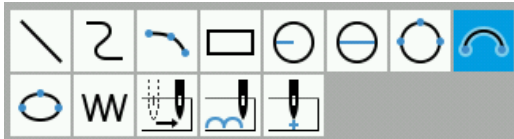

2. Touch .



3. Make the settings for each item.
  - \* Refer to "Setting parameters" (page 27) for details on the setting method.
4. Use the jog key to move the cursor **+** to the point which you would like to set, and then press .

### Creating an ellipse

1. Touch .



2. Touch .

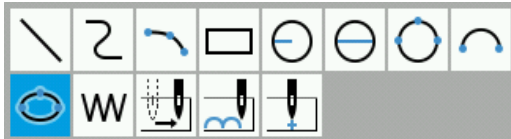

3. Make the settings for each item.
  - \* Refer to "Setting parameters" (page 27) for details on the setting method.

4. Use the jog key to move the cursor **+** to the second point on the long axis (short axis), and then press .



5. Use the jog key to move the cursor **+** to the position for the short axis (long axis), and then press .



## W Creating needle drop data

Create needle drop data for the current needle position.

1. Touch .

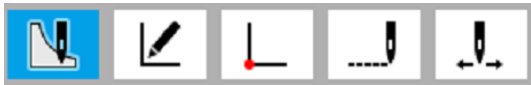

2. Touch **W**.

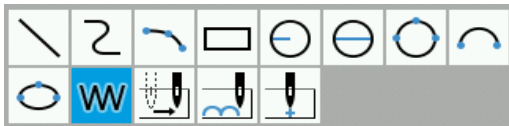

3. Make the settings for each item.  
\* Refer to "Setting parameters" (page 27) for details on the setting method.
4. Use the jog key to move the cursor **+** to the point where you would like to set the needle down position, and then press .

To change the maximum pitch, carry out the same procedure as in step 3 to change the setting.

5. Repeat step 4 until the needle drop position can be set.  
Move the cursor **+** to the end point, and then press  twice.

## Creating feed data

Create (feed) data to move the needle to the next position without needle drop at the current position.

1. Touch .

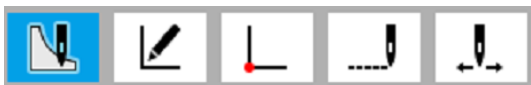

2. Touch .

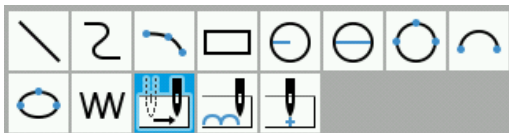



3. Make the settings for each item.  
\* Refer to "Setting parameters" (page 27) for details on the setting method.
4. Use the jog key to move the cursor **+** to the point where you would like to set the feed, and then press  twice.

## Creating basting data

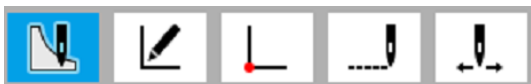

Create basting data.

1. Touch .

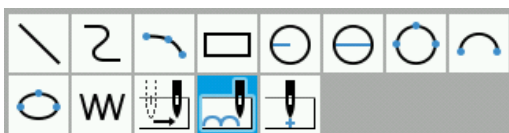

2. Touch .





















3. Make the settings for each item.  
\* Refer to "Setting parameters" (page 27) for details on the setting method.
4. Use the jog key to move the cursor **+** to the point where you would like to set basting, and then press .
5. Repeat step 4 until the basting position can be set.  
Move the cursor **+** to the end point, and then press  twice.

◆ **Setting parameters**





■ Operation method

Parameters are displayed in a list at the right edge of the screen, so touch ◀ ▶ to make the settings.

■ Details of parameter settings

Icon	Parameter	Choices
	Method for Appending *1	Insert, Append to beginning, Append to end
	Method for moving cursor	Move freely, Snap to needle point
	Rotation direction *2	Clockwise, Counterclockwise
	Line type	Running, V Zigzag, N Zigzag
	Running pitch *3	0.3 - 20.0 mm
	Zigzag pitch *4	0.1 - 25.5 mm
	Zigzag left width *4	0.0 - 25.5 mm
	Zigzag right width *4	
	Number of zigzag stitches *4	2 - 4 stitches
	Running generation mode *3	Equal Pitch, Prioritize Pitch
	Backtack entry mode	No Back Tack, V Back, N Back, Overlap *6
	Backtack exit mode	
	Backtack Entry Number of Stitches *5	0 - 9 stitches
	Backtack Exit Number of Stitches *5	
	Maximum Pitch *7	0.3 - 20.0 mm
	Split Auto Insert *8	None, Split w/Needle Up
	Outline connection	Feed, Running, Stitch, Baste
	Single stitch · Multiple stitch mode	Single stitch · Multiple stitch Offset input

## CHAPTER 3 PROGRAMMING PATTERNS

Icon	Parameter	Choices
	Offset direction	Inside/Right side, Outside/Left side
	Offset width	0.0 - 25.5 mm
	No. of copies	1 - 99
	Route	Same direction, Return, Return + Stitch connection

- \*1 When adding an existing pattern, you can select the method for appending the program (Insert, Append to end, Append to beginning).
- \*2 This can only be set when drawing a circle (radius), circle (diameter), semicircle or ellipse.
- \*3 This can only be set when the line type is set to "Running".
- \*4 This can only be set when the line type is set to "V Zigzag" or "N Zigzag".
- \*5 This can only be set when backtack start mode (backtack end mode) is set to a setting other than "No back Tack".
- \*6 This can only be set when drawing a rectangle, circle (radius), circle (diameter), circle (3 points) or ellipse.
- \*7 This can only be set when creating needle drop data.
- \*8 This can only be set when creating feed data or basting data.

### ■ Parameter setting examples

Example 1: To create sewing points which are as even as possible without exceeding the specified pitch:  
Set the running generation mode to "Equal Pitch".

Example 2: To connect the end point of the previous outline and the start point of the current outline by feeding:  
Set the outline connection to "Feed".

## Editing programs (Editing outlines)

The procedure for editing programs using icons is as follows.



### Deleting an outline

1. Touch .



2. Touch .





3. Use  to position the cursor  at the outline which you would like to delete.

4. When you press the  key once, the outline will change to red lines and it will be selected.

When you press the  key once, the selected outline will be unselected.

5. If there is more than one outline that you would like to delete, repeat steps 3 and 4.

\* To select all outlines  
Hold down  to select all outlines.

\* To unselect all outlines  
Hold down  to unselect all selected outlines.

6. Press .



### Moving an outline

1. Touch .

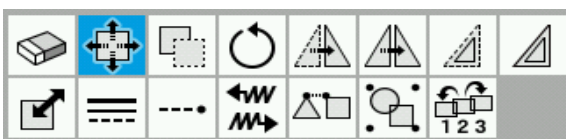

2. Touch .





3. Use  to position the cursor  at the outline which you would like to move.

4. When you press the  key once, the outline will change to red lines and it will be selected.

When you press the  key once, the selected outline will be unselected.

5. If there is more than one outline that you would like to move, repeat steps 3 and 4.

\* To select all outlines  
Hold down  to select all outlines.

\* To unselect all outlines  
Hold down  to unselect all selected outlines.

6. Press .

7. Touch  to set the method for moving the cursor (Move freely, Snap to needle point).



8. Use the jog key to move the cursor  to the place where you would like to move the outline.

9. Press .



### Copying an outline

1. Touch .



2. Touch .





3. Use  to position the cursor  at the outline which you would like to copy.

4. When you press the  key once, the outline will change to red lines and it will be selected.

When you press the  key once, the selected outline will be unselected.

5. If there is more than one outline that you would like to copy, repeat steps 3 and 4.

\* To select all outlines  
Hold down  to select all outlines.

\* To unselect all outlines  
Hold down  to unselect all selected outlines.

6. Press .

7. Touch  to set the method for moving the cursor (Move freely, Snap to needle point).



8. Use the jog key to move the cursor  to the place where you would like to copy the outline.

9. Press .



### Rotating an outline

1. Touch .



2. Touch .





3. Use  to position the cursor  at the outline which you would like to rotate.

4. When you press the  key once, the outline will change to red lines and it will be selected.

When you press the  key once, the selected outline will be unselected.

5. If there is more than one outline that you would like to rotate, repeat steps 3 and 4.

\* To select all outlines  
Hold down  to select all outlines.

\* To unselect all outlines  
Hold down  to unselect all selected outlines.

6. Touch  to set the rotation angle, rotation center point and method for moving the cursor (Move freely, Snap to needle point).

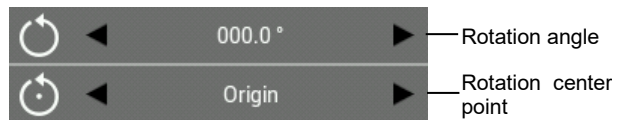



\* Rotation center ... Origin, Center of Mask, Mask top edge, Mask bottom edge, Mask top-left, Mask bottom-left, Mask top-right, Mask bottom-right, Specified point

\* The method for moving the cursor is set only when the rotation center point is set to "Specified point".

7. Press .

\* If the rotation center was set to "Specified point" in step 6, you can use the jog key to move the cursor  so that the current cursor position rotates around the center.

In this case, after moving the cursor , press  once more. In addition, each time you change the rotation angle, the preview is displayed after the outline is rotated.



## Moving an outline symmetrically

1. Touch .



2. Touch .





3. Use  to position the cursor  at the outline which you would like to move symmetrically.

4. When you press the  key once, the outline will change to red lines and it will be selected.

When you press the  key once, the selected outline will be unselected.

5. If there is more than one outline that you would like to move symmetrically, repeat steps 3 and 4.

\* To select all outlines  
Hold down  to select all outlines.

\* To unselect all outlines  
Hold down  to unselect all selected outlines.

6. Touch  to set the symmetry mode and method for moving the cursor (Move freely, Snap to needle point).





\* Symmetry mode ... X-axis, Y-axis, Center of Mask (horizontal), Center of Mask (vertical), Mask top edge, Mask bottom edge, Mask left edge, Mask right edge, Specified axis

\* The method for moving the cursor is set only when the symmetry mode is set to "Specified axis".

7. Press .

\* If the symmetry mode was set to "Specified axis" in step 6, you can use the jog key to move the cursor  so that the current cursor position moves symmetrically around the center.

In this case, after moving the cursor , press  once more. When this is done, each time you change the cursor position, the preview is displayed after the cursor is moved.



## Copying an outline symmetrically

1. Touch .



2. Touch .





3. Use  to position the cursor  at the outline which you would like to copy symmetrically.

4. When you press the  key once, the outline will change to red lines and it will be selected.

When you press the  key once, the selected outline will be unselected.

5. If there is more than one outline that you would like to copy symmetrically, repeat steps 3 and 4.

\* To select all outlines  
Hold down  to select all outlines.

\* To unselect all outlines  
Hold down  to unselect all selected outlines.

6. Touch  to set the symmetry mode and method for moving the cursor (Move freely, Snap to needle point)





\* Symmetry mode  
... X-axis, Y-axis, Center of Mask (horizontal), Center of Mask (vertical), Mask top edge, Mask bottom edge, Mask left edge, Mask right edge, Specified axis

\* The method for moving the cursor is set only when the symmetry mode is set to "Specified axis".

7. Press .

\* If the symmetry mode was set to "Specified axis" in step 6, you can use the jog key to move the cursor  so that the current cursor position moves symmetrically around the center.

In this case, after moving the cursor , press  once more. When this is done, each time you change the cursor position, the preview is displayed after the cursor is moved.





### Moving an outline by an offset

1. Touch .



2. Touch .



3. Use  to position the cursor  at the outline which you would like to move by an offset.

4. When you press the  key once, the outline will change to red lines and it will be selected.

When you press the  key once, the selected outline will be unselected.

\* Outlines which consist of stitches/feeding/basting and outlines which have been loaded from \*.SEW files cannot be moved by an offset.

5. If there is more than one outline that you would like to move by an offset, repeat steps 3 and 4.

\* To select all outlines  
Hold down  to select all outlines.

\* To unselect all outlines  
Hold down  to unselect all selected outlines.

6. Touch  to set the offset direction (Inside/Left Side, Outside/Right Side) and the offset width.

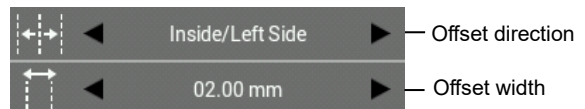

7. Press .



### Copying an outline by an offset

1. Touch .

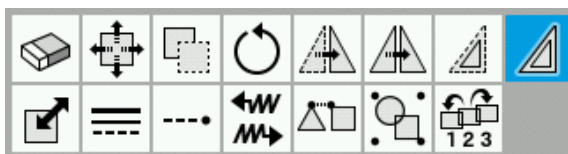

2. Touch .



3. Use  to position the cursor  at the outline which you would like to copy by an offset.

4. When you press the  key once, the outline will change to red lines and it will be selected.

When you press the  key once, the selected outline will be unselected.

\* Outlines which consist of stitches/feeding/basting and outlines which have been loaded from \*.SEW files cannot be copied by an offset.

5. If there is more than one outline that you would like to copy by an offset, repeat steps 3 and 4.

\* To select all outlines  
Hold down  to select all outlines.

\* To unselect all outlines  
Hold down  to unselect all selected outlines.

6. Touch  to set the offset direction (Inside/Left Side, Outside/Right Side), the offset width, the number of offset copies (1 to 99) and the offset creation method (Same Direction, Return, Return + stitch connection).

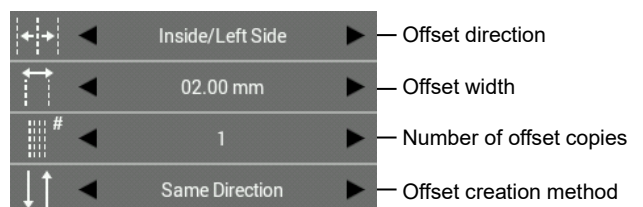

7. Press .



## Resizing an outline

1. Touch .

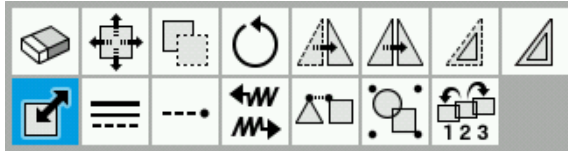

2. Touch .





3. Use  to position the cursor  at the outline which you would like to resize.



4. When you press the  key once, the outline will change to red lines and it will be selected.

When you press the  key once, the selected outline will be unselected.

5. If there is more than one outline that you would like to resize, repeat steps 3 and 4.

\* To select all outlines  
Hold down  to select all outlines.

\* To unselect all outlines  
Hold down  to unselect all selected outlines.

6. Touch   to set the X ratio, Y ratio, resize center, hold element (stitch number or sewing pitch) and method for moving the cursor (Move freely, Snap to needle point).

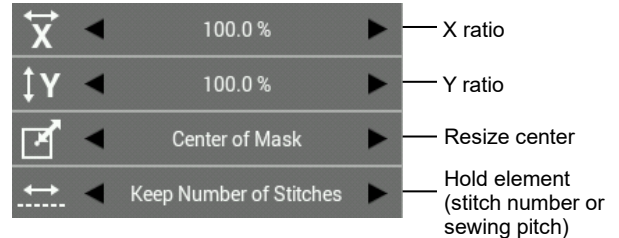



\* Resize center ... Origin, Center of Mask, Mask top edge, Mask bottom edge, Mask top-left, Mask bottom-left, Mask top-right, Mask bottom-right, Specified point

\* The method for moving the cursor is set only when the resize center is set to "Specified point".

7. Press .

\* If the resize center was set to "Specified point" in step 6, you can use the jog key to move the cursor  so that the outline is resized with the current cursor position as the resize center.

In this case, after moving the cursor , press  once more. In addition, each time you change the X ratio or Y ratio, the preview is displayed after the outline is resized.

\* Outlines which consist of stitches/feeding /basting and outlines which have been loaded from \*.SEW files normally have "Keep Number of Stitches" as their hold element.



### ☰ Changing the line type of an outline

1. Touch .



2. Touch .





3. Use   to position the cursor  at the outline which you would like to change the line type for.



4. When you press the  key once, the outline will change to red lines and it will be selected.

When you press the  key once, the selected outline will be unselected.

5. If there is more than one outline that you would like to change the line type for, repeat steps 3 and 4.

\* To select all outlines  
Hold down  to select all outlines.

\* To unselect all outlines  
Hold down  to unselect all selected outlines.

6. Touch   to set the line type (Running, V Zigzag, N Zigzag, Keep Current Shape), pitch and running generation mode (Equal Pitch, Prioritize Pitch).

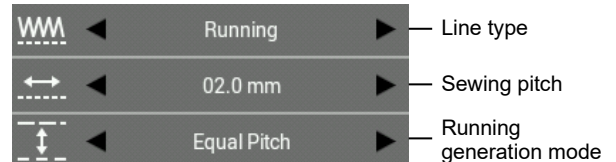

\* For details on the setting method for zigzag stitches, refer to "Zigzag stitch" (page 59).

\* Outlines which consist of stitches/feeding /basting and outlines which have been loaded from \*.SEW files cannot have their line types changed.

7. Press .



### ---- Adding and deleting backtick stitches for an outline

1. Touch .

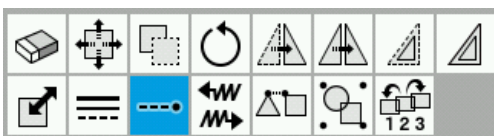

2. Touch .





3. Use   to position the cursor  at the outline which you would like to add or delete backtacking for.



4. When you press the  key once, the outline will change to red lines and it will be selected.

When you press the  key once, the selected outline will be unselected.

5. If there is more than one outline that you would like to add or delete backtacking for, repeat steps 3 and 4.

\* To select all outlines  
Hold down  to select all outlines.

\* To unselect all outlines  
Hold down  to unselect all selected outlines.

6. Touch   to set the backtick type (start position), number of backtick stitches (0 to 9), backtick type (end position) and number of backtick stitches (0 to 9).

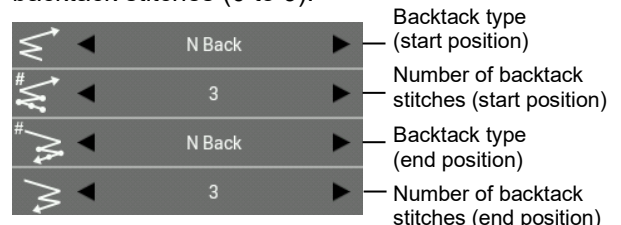

\* Backtick stitch type ...  
No Back Tack, V Back, N Back, Overlap

\* The "Overlap" setting can only be set for closed outlines (circles specified by radius, circles specified by diameter, circles specified by three points, ellipses, rectangles, etc.).

7. Press .



## Switching the sewing start and end points for outlines

1. Touch .



2. Touch .





3. Use  to position the cursor  at the outline which you would like to switch the outline start point or end point for.

4. When you press the  key once, the outline will change to red lines and it will be selected.

When you press the  key once, the selected outline will be unselected.

5. If there is more than one outline that you would like to switch the start point or end point for, repeat steps 3 and 4.

\* To select all outlines  
Hold down  to select all outlines.

\* To unselect all outlines  
Hold down  to unselect all selected outlines.

6. Press .

\* When multiple continuous outlines are selected, the orders are also switched.

Example: When outlines 1, 2, 3 and 4 have been created, and you select outlines 1, 2 and 4 (red lines) and switch the start and end points:

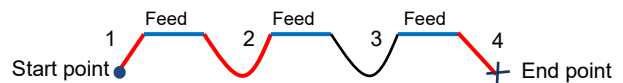

The sewing order becomes 1', 2', 3, 4'.  
(The start and end point for 1', 2' and 4' are reversed.)

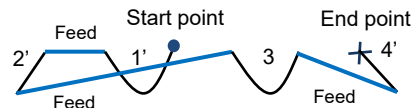



## Changing the connection method for outlines

1. Touch .



2. Touch .





3. Use  to position the cursor  at the outline which you would like to change the outline connection method for.

4. When you press the  key once, the outline will change to red lines and it will be selected.

When you press the  key once, the selected outline will be unselected.

5. If there is more than one outline that you would like to change the outline connection method for, repeat steps 3 and 4.

\* To select all outlines  
Hold down  to select all outlines.

\* To unselect all outlines  
Hold down  to unselect all selected outlines.

6. Touch  to set the outline connection method (Stitch, Feed, Running, Baste).



\* If "Stitch" is set as the outline connection method:  
If the maximum pitch of the stitches exceeds 20.0mm, use the "Feed" setting to connect.

\* If "Running" is set as the outline connection method: The outline is connected by a straight line at the current outline running pitch.

7. Press .

\* The end point of the previous outline and the start point of the current outline are connected.



## Combining outlines

1. Touch .



2. Touch .





3. Use  to position the cursor  at an outline which you would like to combine.

4. When you press the  key once, the outline will change to red lines and it will be selected.

When you press the  key once, the selected outline will be unselected.

5. If there is more than one outline that you would like to combine, repeat steps 3 and 4.

\* To select all outlines  
Hold down  to select all outlines.

\* To unselect all outlines  
Hold down  to unselect all selected outlines.

6. Press .

- \* The following outlines cannot be combined.
  - Closed outlines (circles specified by radius, circles specified by diameter, circles specified by three points, ellipses, rectangles, etc.)
  - Outlines which consist of stitches/feeding /basting and other types of outlines

\* If only one outline is selected, it will become a closed outline.

<Example>

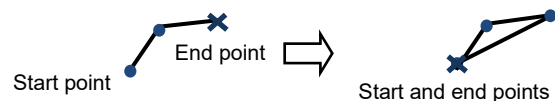



## Changing the sewing order for an outline

1. Touch .

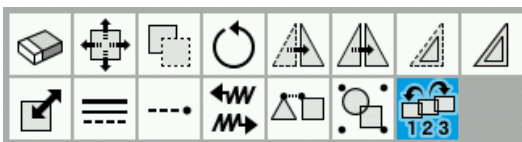

2. Touch .





3. Use  to position the cursor  at the outline which you would like to change the outline sewing order for.



4. When you press the  key once, the outline will change to red lines and it will be selected.

When you press the  key once, the selected outline will be unselected.

5. If there is more than one outline that you would like to change the outline sewing order for, repeat steps 3 and 4.

\* To select all outlines  
Hold down  to select all outlines.

\* To unselect all outlines  
Hold down  to unselect all selected outlines.

6. Touch   to set the sewing order (Move Forward, Move Back, Move to start, Move to end).



7. Press .

**Editing programs (Editing outline component points)**

This section describes the icons which are used when editing outline component points and how to use them.  
 \* You cannot edit the outline component points for outlines which have been loaded from \*.SEW files.

 **Deleting an outline component point**

1. Touch .



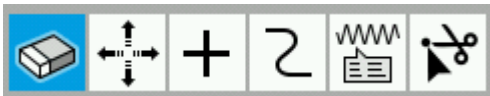

2. Touch .



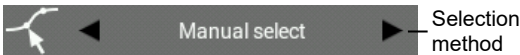

3. Touch   to set the selection method.



■ **Selecting continuous component points for editing**

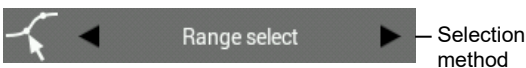

4. Touch   to set the selection method to "Range select".



5. Use  to move the cursor  to the start point for the range that you would like to select.

\* You can move the cursor continuously by holding down the key.



6. Press .

7. Use  to move the cursor  to the end point of the range that you would like to select. The component points will change to red, and the points from the start point to the end point will be selected.



\* You can move the cursor continuously by holding down the key.

8. Press .

■ **Manually selecting component points for editing**

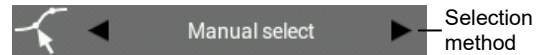
4. Touch   to set the selection method to "Manual select".



5. Use  to move the cursor  to the component point that you would like to delete.

\* You can move the cursor continuously by holding down the key.

6. When you press the  key once, the component point will change to red and it will be selected.

When you press the  key once, the selected component point will be unselected.

7. If there is more than one component point that you would like to delete, repeat steps 5 and 6.

\* To select all outlines  
 Hold down  to select all component points in an outline.

\* To unselect all outlines  
 Hold down  to unselect all selected component points.

8. Press .



## ✚ Moving an outline component point

1. Touch .

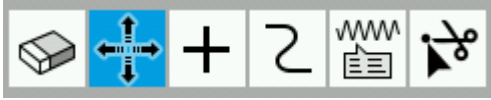

2. Touch .



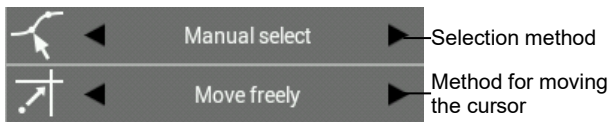

3. Touch   to set the selection method (Manual select, Range select) and method for moving the cursor (Move freely, Snap to needle point).







\* If the method for moving the cursor is set to "Move freely", the cursor can be moved to any desired position.

\* If the method for moving the cursor is set to "Snap to needle point", the cursor will move to the sewing point.

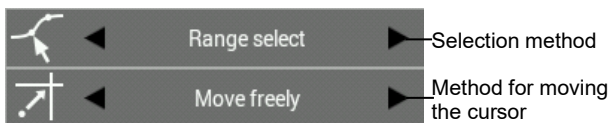
### ■ Selecting continuous component points for editing



4. Touch   to set the selection method to "Range select".





5. Use   to move the cursor  to the start point for the range that you would like to select.

\* You can move the cursor continuously by holding down the key.

6. Press .



7. Use   to move the cursor  to the end point of the range that you would like to select. The component points will change to red, and the points from the start point to the end point will be selected.

\* You can move the cursor continuously by holding down the key.



8. Press  once, and then use the jog key to move the cursor  to the place where you would like to move the component point.

9. Press .

### ■ Manually selecting component points for editing

4. Touch   to set the selection method to "Manual select".



5. Use   to move the cursor  to the component point that you would like to move.

\* You can move the cursor continuously by holding down the key.

6. When you press the  key once, the component point will change to red and it will be selected.

When you press the  key once, the selected component point will be unselected.



7. If there is more than one component point that you would like to move, repeat steps 5 and 6.

\* To select all outlines

Hold down  to select all component points in an outline.

\* To unselect all outlines

Hold down  to unselect all selected component points.

8. Press  once, and then use the jog key to move the cursor  to the place where you would like to move the component point.

9. Press .



## + Adding an outline component point

1. Touch .



2. Touch .



3. Use  to move the cursor  to the component point where you would like to add a component point.

\* You can move the cursor continuously by holding down the key.

4. Press .

\* The component point will be automatically added between the selected component point and the next component point.

\* You cannot add component points for circles (circles specified by radius, circles specified by diameter, circles specified by three points) and ellipses.



## ~ Changing curve shapes

1. Touch .



2. Touch .



3. Use  to move the cursor  to the component point in the curve that you would like to edit.

\* You can move the cursor continuously by holding down the key.

4. Press .

\* You can only change the current component point if it and the component points immediately before and after it are part of a curve.

5. Use the jog key to edit the curve.

\* To rotate the curve clockwise  
Hold down  to rotate the curve clockwise.

\* To rotate the curve counterclockwise  
Hold down  to rotate the curve counterclockwise.

6. Press .







## Changing the attributes of outline component points

1. Touch .

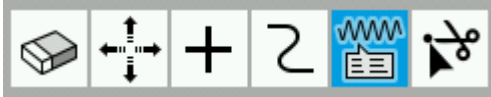

2. Touch .



3. Use  to move the cursor  to the component point that you would like to change the attributes for.

\* You can move the cursor continuously by holding down the key.

4. Touch  to select the attribute (Straight line, Curve) to change. The attribute of the component point will then be changed.

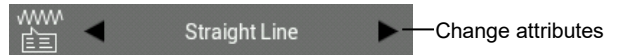

\* You cannot change the attributes for component points in circles (circles specified by radius, circles specified by diameter, circles specified by three points) and ellipses.

\* It is possible to change arcs into straight lines or curves, but straight lines and curves cannot be changed into arcs.





## Separating an outline at a component point

1. Touch .

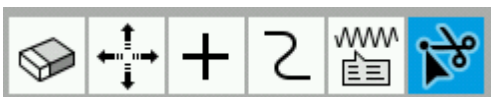

2. Touch .



3. Use  to move the cursor  to the component point in the outline where you would like to separate the outline.

\* You can move the cursor continuously by holding down the key.

4. Press .

\* Circles (circles specified by radius, circles specified by diameter, circles specified by three points), ellipses and outlines which consist of stitches/feeding/basting cannot be separated.

\* The outline will be separate at the position of the selected component point.

Example: To separate outline 1 at component point A

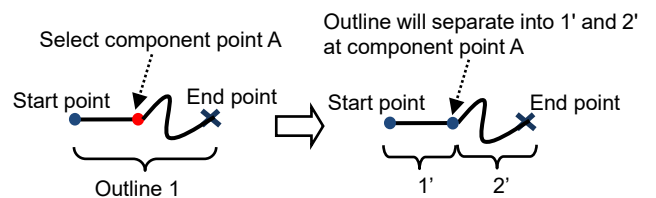

**Editing programs (Editing sewing points)**

This section describes the icons which are used when editing sewing points and how to use them.



 **Deleting a sewing point**

1. Touch .





2. Touch .



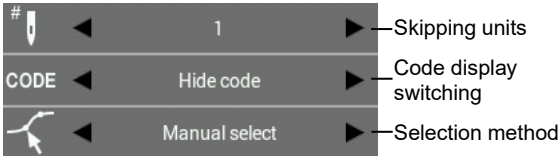



3. Touch   to set the skipping units (1, 10, 50, 100, 500, 1000, 5000), code display switching (Hide code, Show code) and the selection method.

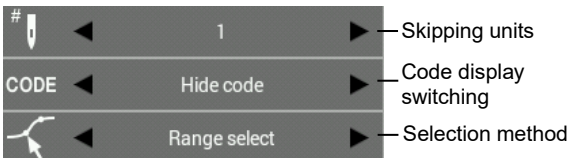

**■ Selecting continuous sewing points for editing**



4. Touch   to set the selection method to "Range select".



5. Use   to move the cursor  to the start point for the range that you would like to select.

- \* You can move the cursor according to the skipping units.
- \* You can move the cursor continuously by holding down the key.



6. Press .

7. Use   to move the cursor  to the end point of the range that you would like to select. The sewing points will change to red, and the points from the start point to the end point will be selected.



- \* You can move the cursor according to the skipping units.
- \* You can move the cursor continuously by holding down the key.

8. Press .

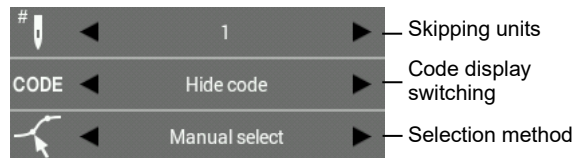

**■ Manually selecting sewing points for editing**

4. Touch   to set the selection method to "Manual select".





5. Use   to move the cursor  to the sewing point that you would like to delete.

- \* You can move the cursor according to the skipping units.
- \* You can move the cursor continuously by holding down the key.

6. When you press the  key once, the sewing point will change to red and it will be selected. When you press the  key once, the selected sewing point will be unselected.

7. If there is more than one sewing point that you would like to delete, repeat steps 5 and 6.

- \* To select all outlines  
Hold down  to select all sewing points in an outline.
- \* To unselect all outlines  
Hold down  to unselect all selected sewing points.

8. Press .



## ✚ Moving a sewing point

1. Touch .



2. Touch .



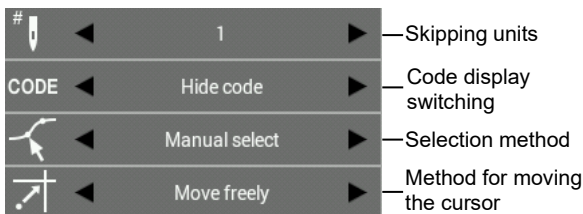

3. Touch   to set the skipping units (1, 10, 50, 100, 500, 1000, 5000), code display switching (Hide code, Show code) and method for moving the cursor (Move freely, Snap to needle point).







\* If the method for moving the cursor is set to "Move freely", the cursor can be moved to any desired position.

\* If the method for moving the cursor is set to "Snap to needle point", the cursor will move to the sewing point.

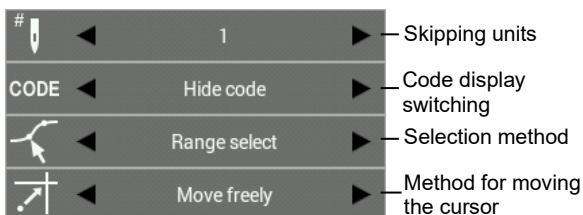
### ■ Selecting continuous sewing points for editing

4. Touch   to set the selection method to "Range select".





5. Use   to move the cursor  to the start point for the range that you would like to select.

\* You can move the cursor according to the skipping units.



\* You can move the cursor continuously by holding down the key.

6. Press .

7. Use   to move the cursor  to the end point of the range that you would like to select. The sewing points will change to red, and the points from the start point to the end point will be selected.



\* You can move the cursor according to the skipping units.

\* You can move the cursor continuously by holding down the key.



8. Press  once, and then use the jog key to move the cursor  to the place where you would like to move the component point.

9. Press .

### ■ Manually selecting component points for editing

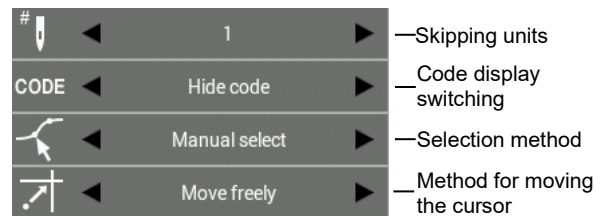

4. Touch   to set the selection method to "Manual select".



5. Use   to move the cursor  to the sewing point that you would like to move.

\* You can move the cursor according to the skipping units.

\* You can move the cursor continuously by holding down the key.

6. When you press the  key once, the sewing point will change to red and it will be selected. When you press the  key once, the selected sewing point will be unselected.



7. If there is more than one sewing point that you would like to move, repeat steps 5 and 6.

\* To select all outlines

Hold down  to select all sewing points in an outline.

\* To unselect all outlines

Hold down  to unselect all selected sewing points.

8. Press  once, and then use the jog key to move the cursor  to the place where you would like to move the component point.

9. Press .



## + Adding a sewing point

1. Touch .



2. Touch .





3. Touch   to set the skipping units (1, 10, 50, 100, 500, 1000, 5000), code display switching (Hide code, Show code), sewing point method for appending (Add Manually, Add Automatically) and method for moving the cursor (Move freely, Snap to needle point).

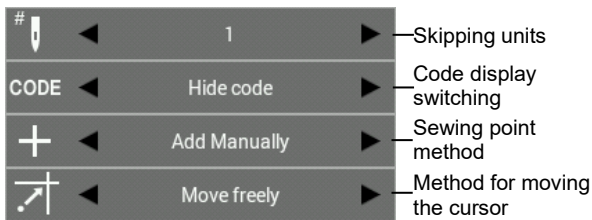

\* The method for moving the cursor is only displayed when the sewing point method for appending is set to "Add Manually".

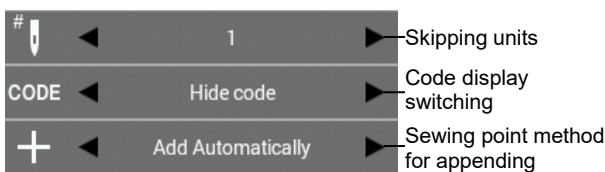

### ■ Adding sewing points automatically

4. Touch   to set the sewing point method for appending to "Add Automatically".



5. Use   to move the cursor  to the sewing point where you would like to add a sewing point.



\* You can move the cursor according to the skipping units.

\* You can move the cursor continuously by holding down the key.



6. Press .

\* The sewing point will be automatically added between the selected sewing point and the next sewing point.

### ■ Adding sewing points manually

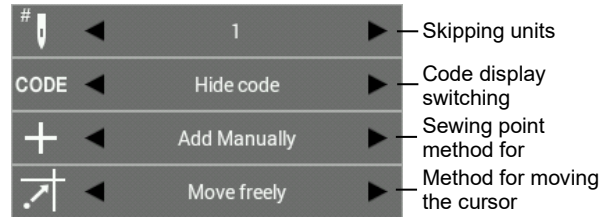

4. Touch   to set the sewing point method for appending to "Add Manually".



5. Use   to move the cursor  to the sewing point where you would like to add a sewing point.

\* You can move the cursor according to the skipping units.

\* You can move the cursor continuously by holding down the key.

6. Press  once, and then use the jog key to move the cursor  to the place where you would like to add the sewing point.

\* If the method for moving the cursor is set to "Move freely", the cursor can be moved to any desired position.

\* If the method for moving the cursor is set to "Snap to needle point", the cursor will move to the sewing point.

7. Press .

\* The sewing point will be added in between the selected sewing point and the next sewing point at the position where the cursor was moved to in step 6.





## Changing the attributes of sewing points

1. Touch .





2. Touch .



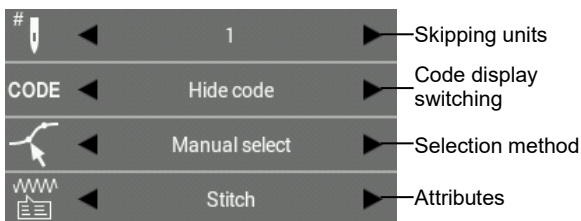

3. Touch   to set the skipping units (1, 10, 50, 100, 500, 1000, 5000) and code display switching (Hide code, Show code).



### ■ Selecting continuous sewing points for editing



4. Touch   to set the selection method to "Range select".

5. Use   to move the cursor  to the start point for the range that you would like to select.

\* You can move the cursor according to the skipping units.



\* You can move the cursor continuously by holding down the key.

6. Press .

7. Use   to move the cursor  to the end point of the range that you would like to select. The sewing points will change to red, and the points from the start point to the end point will be selected.



\* You can move the cursor according to the skipping units.



\* You can move the cursor continuously by holding down the key.

8. Touch   to set the attribute (Stitch, Feed, Baste).

9. Press .



### ■ Manually selecting component points for editing

4. Touch   to set the selection method to "Manual select".

5. Use   to move the cursor  to the sewing point that you would like to move.

\* You can move the cursor according to the skipping units.

\* You can move the cursor continuously by holding down the key.

6. When you press the  key once, the sewing point will change to red and it will be selected. When you press the  key once, the selected sewing point will be unselected.



7. If there is more than one attribute that you would like to change, repeat steps 5 and 6.

\* To select all outlines

Hold down  to select all sewing points in an outline.

\* To unselect all outlines

Hold down  to unselect all selected sewing points.

8. Touch   to set the attribute (Stitch, Feed, Baste).

9. Press .

\* When switching from "Feed" to "Stitch" or from "Baste" to "Stitch", the sewing pitch must be 20.0mm or less for both X and Y. If the setting is outside the range, the buzzer will sound twice and processing will stop.

## Separating an outline at a sewing point

\* When separating outlines at sewing points when the outlines contain component point data, the component point data will be lost.

1. Touch .





2. Touch .

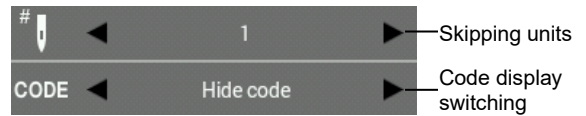

3. Touch  to set the skipping units (1, 10, 50, 100, 500, 1000, 5000) and code display switching (Hide code, Show code).



4. Use  to move the cursor  to the sewing point in the outline where you would like to separate the outline.

\* You can move the cursor continuously by holding down the key.

5. Press .

## ----• Setting bar tacking at a sewing point

1. Touch .





2. Touch .



3. Touch  to set the skipping units (1, 10, 50, 100, 500, 1000, 5000) and code display switching (Hide code, Show code).



4. Use  to move the cursor  to the sewing point where you would like to set backtacking.

\* You can move the cursor according to the skipping units.

\* You can move the cursor continuously by holding down the key.

5. Touch  to set the number of backtack operations (1 to 9) and the number of backtack stitches (1 to 9).

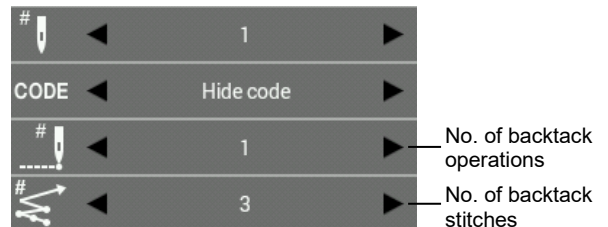

\* You cannot set backtacking to cross from one outline to another, or set it at the sewing start point.

If you would like to set backtacking at the sewing start point, refer to "Adding and deleting backtack stitches for an outline" on page 35.

6. Press .

\* Backtacking will be set in the return direction from the current sewing point.



**CODE** Adding and deleting codes at sewing points

1. Touch .



2. Touch **CODE**.



3. Use  to move the cursor  to the sewing point where you would like to add or delete a code.

\* You can move the cursor continuously by holding down the key.

4. Touch the place where you would like to add or delete a code. The code will be added or deleted.





\* Depending on the type of code, the selection of codes for adding and deleting may take place in the screen destination.

To return to the previous screen, touch



\* Refer to "List of code settings" (page 48) for a list of the codes which can be set.

\* After touching the code, you can hold down the  keys to move the cursor  to the previous or next applicable point when a code is inserted. The cursor will move in a straight line from the current point to the applicable point.

5. If you touch the icons at the top of the screen, you can check the setting details for the codes.

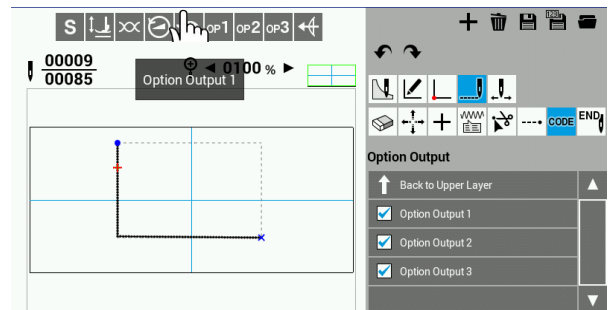

\* Sewing points which have a code set will change to green.

**END** Editing end codes

1. Touch .

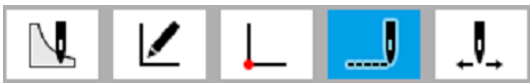

2. Touch **END**.



3. Touch the end code that you would like to change.



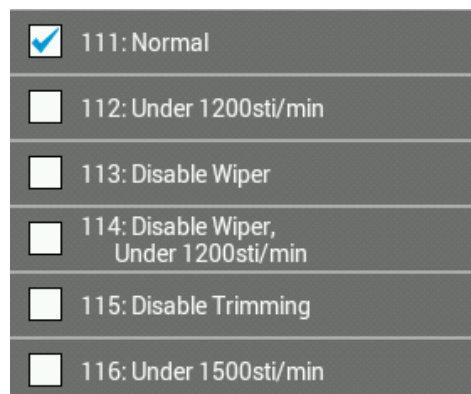







The end code for the final sewing point will be changed.



\* For details on the codes that can be set, refer to "5. Editing end codes" in the programming procedures (page 18).

## CHAPTER 3 PROGRAMMING PATTERNS

### List of code settings

Name		Setting value	Icons*2	Notes
Split		Needle Up/Needle Down		
Intermittent presser foot height		-10.0 - 10.0mm (Setting units: 0.1mm)		
Thread tension (tension)		0 - 500		
Sewing speed		200 - 2800sti/min (Setting units: 100 sti/min) (The maximum sewing speed is limited to the above setting or less)		
Low-speed		0: Low-speed cancel 1: Limits the maximum sewing speed to 1200 sti/min or less 2: Limits the maximum sewing speed to 800 sti/min or less 3: Limits the maximum sewing speed to 600 sti/min or less 4: Limits the maximum sewing speed to 400 sti/min or less		
Option output	Option output 1	ON/OFF *1		
	Option output 2	ON/OFF *1		
	Option output 3	ON/OFF *1		
Trigger	Option No.	1 - 24		* Up to five can be set for each sewing point.
	Sewing machine stop	Paused/Not Paused		
Thread trimming		Enabled/Disabled		* When the feed has been set, the end point of the stitch is set automatically.

\*1 On when selected, off when not selected.

\*2 When code display is set to "Show code" during sewing editing or checking, the icons are displayed in the top-left of the screen.

The icons are always displayed during code setting.





## Checking programs

This section describes the icons which are used when checking programs and how to use them.

### **Checking each stitch**





1. Touch .

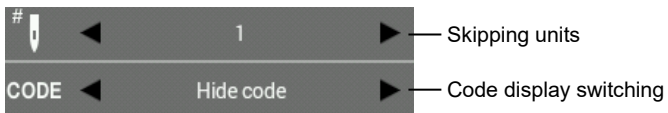

2. Touch   to set the skipping units (1, 10, 50, 100, 500, 1000, 5000) and code display switching (Hide code, Show code).



\* Refer to the "List of code settings" (page 48) for a list of the codes which are displayed when code display switching is set to "Show code".





3. Touch  or . (Or, operation is also possible using  .)







\* To move backward

Touch , or use .

Hold down  or . The cursor  will move back by the skipping units while the key is being pressed.

\* To move forward

Touch , or use .

Hold down  or . The cursor  will move forward by the skipping units while the key is being pressed.

## Moving to the start position

---

1. Touch .



2. Touch .

The feed will return to the sewing start position.



## Measuring distances

---

1. Touch .



2. Touch .



3. Touch ◀ ▶ to set the method for moving the cursor (Move freely, Snap to needle point).



4. Use the jog key to move the cursor + to the start point that you would like to measure.

5. Press .

6. Use the jog key to move the cursor + to the position that you would like to measure.

- \* The distance between the measurement start position and the current cursor position is displayed as  $\Delta X$  and  $\Delta Y$ .
- \* The line linking the measurement start position and the current cursor position is displayed.

## Programming example

This section describes how to create a program, using an actual program as an example.

- ◆ Programming for each stitch: Page 51
- ◆ Pattern with lines: Page 52
- ◆ Pattern with curves: Page 53
- ◆ Double stitch and multiple stitch: Page 54
- ◆ Continuous sewing with the work clamp in position after thread trimming(feed): Page 55
- ◆ Basting: Page 56
- ◆ Symmetrical pattern: Page 57
- ◆ Programming while entering splits in different patterns: Page 58
- ◆ Zigzag stitch: Page 59

- \* For function and operating information about each icon, refer to "Programming" (page 22).
- \* In the programming example, point A in the illustration is the first stitch.

### WW Programming for each stitch

The following describes how to perform programming for each stitch according to the pattern sheet.

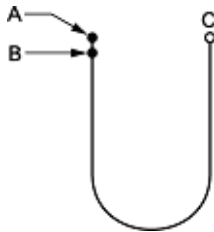

1. Carry out steps 1 to 3 in "Programming procedure" (page 17).
  2. Touch .
- 
3. Touch **WW** .
- 
4. Use the jog key to move the cursor + to B.
  5. Press .
  6. Repeat steps 4 and 5 to move the cursor to C.
  7. Press .
  8. Carry out steps 5 and after in "Programming procedure" (page 18).

## CHAPTER 3 PROGRAMMING PATTERNS

### \ Pattern with lines

This section describes how to program shapes which include straight lines, using an actual program as an example.

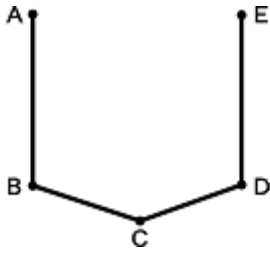

1. Carry out steps 1 to 3 in "Programming procedure" (page 17).

2. Touch .

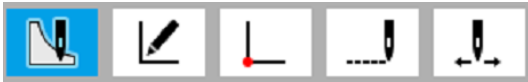

3. Touch .

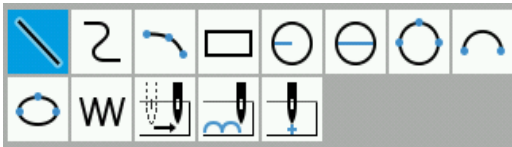

4. Use the jog key to move the cursor + to B.

5. Press .

6. Carry out the same operation in steps 4 and 5 for C, D and E.

7. Press .

8. Carry out steps 5 and after in "Programming procedure" (page 18).

## 2 Pattern with curves

This section describes how to program shapes which include curved lines, using an actual program as an example.

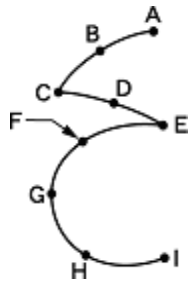

Be sure to press  twice to make a split at corner points C or E. If a split is not made, the corner will be rounded.

When a split is made



When a split is not made



Making more intermediate points such as points B, D, F, G, and H creates smoother curves.

1. Carry out steps 1 to 3 in "Programming procedure" (page 17).

2. Touch .



3. Touch .

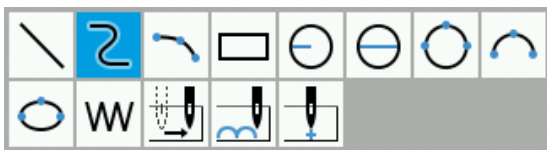

4. Use the jog key to move the cursor + to B.

5. Press .

6. Repeat steps 4 and 5 to move the cursor + to C.

7. Press  twice to insert a split.

8. Move the cursor + to E.

9. Press  twice to insert a split.

10. Move the cursor + to I.

11. Press  twice.

12. Carry out steps 5 and after in "Programming procedure" (page 18).

## Double stitch and multiple stitch

If you would like to program multiple lines at a constant width away from another line, you can create the lines using offset copying.

This section describes how to program double stitches on the left side of another line in the sewing direction, using an actual program as an example.

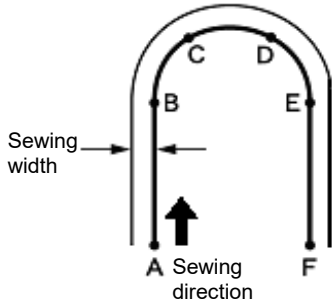

Be sure to press  twice to make a split at a point B or E where the line changes to the curve. Placing more intermediate points such as points C and D creates smoother curves.

1. Carry out steps 1 to 3 in "Programming procedure" (page 17).

2. Use the functions for creating straight or curved lines to create an outline from A to F.

\* Refer to "Pattern with lines" (page 52) or "Pattern with curves" (page 53).

3. Touch .

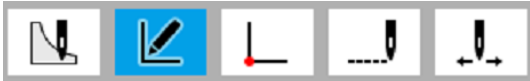

4. Touch .

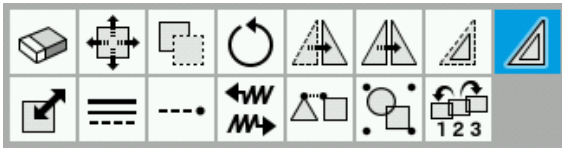

5. Touch  to set whether the double stitch will be created to the left or the right of the sewing direction.

To create the line to the left of the sewing direction:

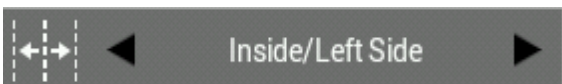

To create the line to the right of the sewing direction



6. Touch  to set the sewing width and the number of copies.

Example: To sew a double stitch at a sewing width of 3.0 mm, set the sewing width to "03.00mm" and the number of copies to "1".

\* To sew multiple stitches, set the number of copies to the number of additional lines to be sewn.

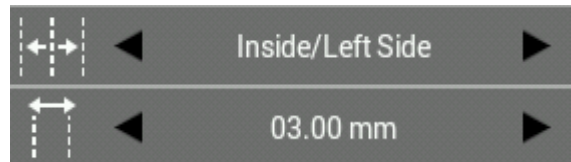

7. Touch  to set the offset method (Same Direction, Return, Return + Stitch Connection).

Example: To copy in the same direction as the sewing direction, set the offset creation method to "Same Direction".



8. Use the jog key to select the whole of the outline which was created in step 2.

\* The outline which is selected will be displayed in red.

9. Press .

10. The selected outline will be copied in the specified sewing direction.

11. Carry out steps 5 and after in "Programming procedure" (page 18).



## Continuous sewing with the work clamp in position after thread trimming (feed)

Set "feed" to continue sewing with the work clamp in position after thread trimming. The following describes how to program pattern 2 with a feed after pattern 1.

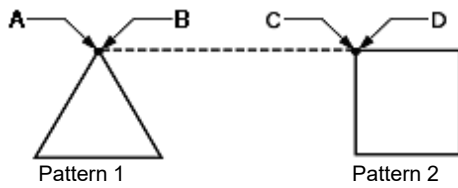

1. Carry out steps 1 to 3 in "Programming procedure" (page 17).
2. Create the outline for pattern 1.  
\* Refer to "Pattern with lines" (page 52).
3. Touch .
4. Touch .
5. Use the jog key to move the cursor + to C.
6. Press twice.
7. Create the outline for pattern 2.  
\* Refer to "Pattern with lines" (page 52).
8. Carry out steps 5 and after in "Programming procedure" (page 18).

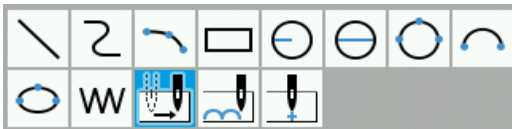
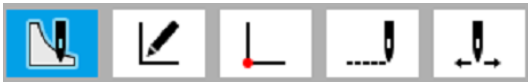

 **Basting**

The following describes how to program basting from point C to point F.

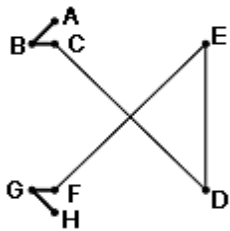



1. Carry out steps 1 to 3 in "Programming procedure" (page 17).
2. Use the function for creating straight lines to create an outline from A to C.  
\* Refer to "Pattern with lines" (page 52).

3. Touch .

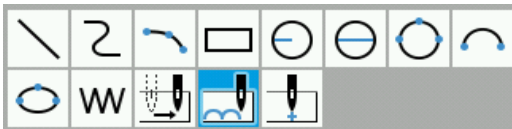

4. Touch .



5. Use the jog key to move the cursor + to D.
6. Press .
7. Repeat steps 5 and 6 to move the cursor + to F.
8. Press  twice.
9. Repeat step 2 to create the outline from F to H.  
\* Refer to "Pattern with lines" (page 52).
10. Carry out steps 5 and after in "Programming procedure" (page 18).



## Symmetrical pattern

When programming a symmetrical pattern, program a target pattern and then select a symmetrical pattern type.

This section describes how to program shapes which are symmetrical along the Y axis, using an actual program as an example.

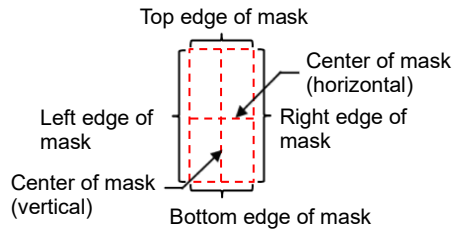
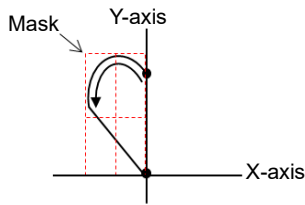

### Symmetrical pattern type

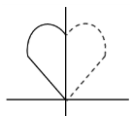

#### Symmetrical to Y-axis

Select "Symmetrical along Y axis".

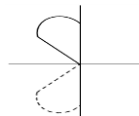

#### Symmetrical to X-axis

Select "Symmetrical along X axis".

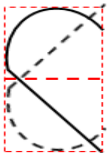

#### Center of mask (horizontal)

Select "Center of Mask (Horizontal)".



#### Center of mask (vertical)

Select "Center of Mask (Vertical)".

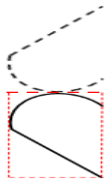

#### Top edge of mask

Select "Mask top edge".

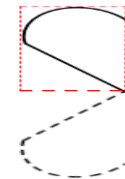

#### Bottom edge of mask

Select "Mask bottom edge".

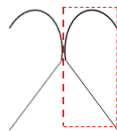

#### Left edge of mask

Select "Mask Left Edge".



#### Right edge of mask

Select "Mask Right Edge".



1. Carry out steps 1 to 3 in "Programming procedure" (page 17).
2. Use the functions for creating feed data or curved lines to create an outline from A to B. Refer to "Programming for each stitch" (page 51) or "Pattern with curves" (page 53).

3. Touch .

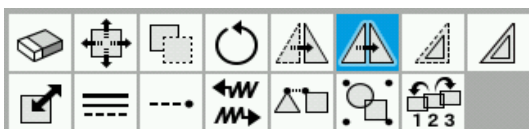

4. Touch .



5. Touch   to select the symmetry mode. In the example, "Symmetrical along Y axis" is selected.



6. Use the jog key to select the whole of the outline which was created in step 2. The outline which is selected will be displayed in red.

7. Press .

The selected outline will be copied symmetrically along the Y axis.

8. Carry out steps 5 and after in "Programming procedure" (page 18).

### Programming while entering splits in different patterns

Multiple patterns are programmed splitting each pattern in sequence.  
The following describes how to program 3 patterns in sequence.

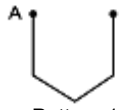

Pattern 1



Pattern 2

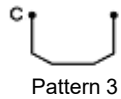

Pattern 3

1. Carry out steps 1 to 3 in "Programming procedure" (page 17).
2. Create the outline for pattern 1.  
\* Refer to "Pattern with lines" (page 52).

3. Touch .



4. Touch .

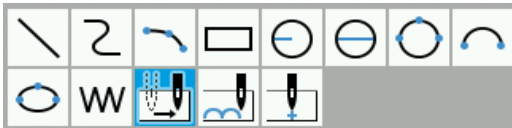

5. Touch ◀ ▶ to set a split.



6. Use the jog key to move the cursor + to B.
7. Press twice.
8. Create the outline for pattern 2.  
\* Refer to "Pattern with lines" (page 52).
9. Carry out steps 3 to 5 once more.
10. Use the jog key to move the cursor + to C.
11. Press twice.
12. Create the outline for pattern 3.  
\* Refer to "Pattern with lines" (page 52).
13. Carry out steps 5 and after in "Programming procedure" (page 18).

## Zigzag stitch

This section describes how to program a zigzag stitch which moves to the left and right while centered on the sewing start point (A), using an actual program as an example.

Two types of zigzag sewing can be selected: V-type zigzag and N-type zigzag. The left and right zigzag widths can also be set separately for each type. In addition, zigzag stitches with curved lines can also be programmed. (A description of the programming method using V-type zigzag sewing is given as an example.)

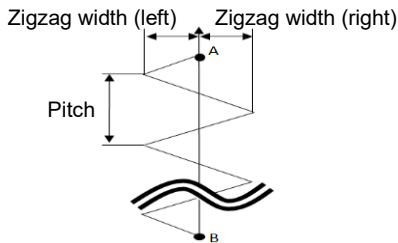

1. Carry out steps 1 to 3 in "Programming procedure" (page 17).

2. Touch .



3. Touch .

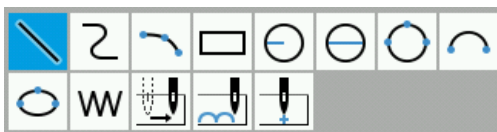

\* To program curved-line zigzag stitches, touch .

4. Touch to change to "V-type zigzag".



5. Set the running pitch and zigzag width for V-type zigzag stitches.

Example: To set the running pitch to 3.0 mm:  
Touch to set the running pitch to "03.0mm".



6. Set the zigzag width (right) for V-type zigzag stitches.

Example: To set the zigzag width (right) to 1.0 mm: Touch to set the zigzag width (right) to "01.0mm".



7. Set the zigzag width (left) for V-type zigzag stitches.

Example: To set the zigzag width (left) to 1.0 mm: Touch to set the zigzag width (left) to "01.0mm".



8. Set the number of zigzags for V-type zigzag stitches.

Example: To set the number of zigzag stitches to 2: Touch to set the number of zigzags to "2".



9. Use the jog key to move the cursor to B.

10. Press twice.

\* To program curved-line zigzag stitches, repeat this procedure.

11. Carry out steps 5 and after in "Programming procedure" (page 18).

### Example of modified program

This section describes the program modification methods using specific examples.

- ◆ Resizing a pattern: Page 61
- ◆ Modifying a part of pattern: Page 62
- ◆ Deleting the first stitch to change the sewing start point to the second stitch: Page 63
- ◆ Moving the sewing start point: Page 64
- ◆ Adding a new sewing start point before the first stitch: Page 65
- ◆ Adding an escape point before the sewing start point: Page 66
- ◆ Modifying a pattern by moving a component point: Page 67
- ◆ Modifying a pattern by adding a component point: Page 68
- ◆ Modifying a pattern by deleting a component point: Page 69
- ◆ Moving the pattern in parallel (when the first stitch is the sewing start point): Page 70
- ◆ Deleting a part of data during programming: Page 71
- ◆ Moving a part of a continuous program in parallel: Page 72
- ◆ Moving a part of a continuous program in parallel partially: Page 73
- ◆ Inserting a straight line into a pattern: Page 74 - 76

## Resizing a pattern

The following describes how to resize a programmed pattern.

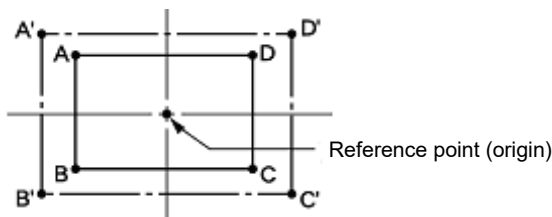

The reference point for resizing patterns is the center point for enlarging or reducing the pattern size.

1. Carry out step 8 in "Programming procedure" (page 20).

2. Touch .



3. Touch .





4. Use  to select the pattern which you would like to resize.

5. When you press the  key once, the pattern will change to red lines and it will be selected.

6. Touch  and enter the resizing ratios for the X direction and Y direction.

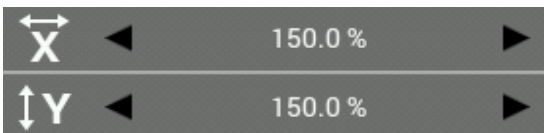
Example: To enlarge by 150%: Change the resize setting to "150.0%".



7. Touch  to set the resize center.

Example: To resize centering on the origin: Set the resize center to "Origin".

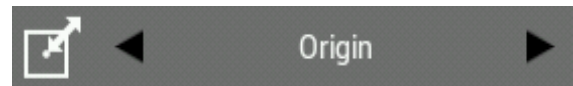

8. Touch  to set the hold element.

Example: To resize while maintaining the same number of stitches as in the original data: Set the hold element to "Keep Number of Stitches".

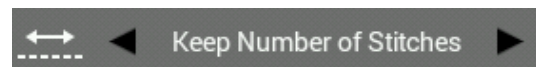

9. Press .

The pattern will be resized.

\* If the resize center was set to "Specified point" in step 7, you can use the jog key to move the cursor + so that the outline can be resized with the current cursor position as the resize center.

In this case, after moving the cursor +, press  once more.

In addition, each time you change the resize ratio, the preview is displayed after the outline is resized.

10. Carry out steps 6 and 7 in "Programming procedure" (page 19, 20).

## Modifying a part of pattern

The part of the programmed pattern is changed.

The following describes how to modify 5, 6 and 7 to 5', 6' and 7'.

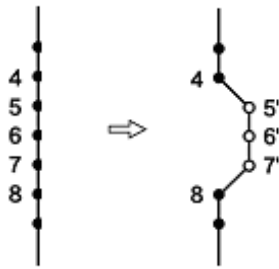

1. Carry out step 8 in "Programming procedure" (page 20).

2. Touch .

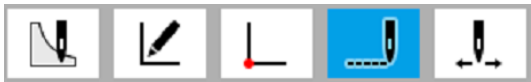

3. Touch .



4. Touch to select "Range select".



5. Use to move the cursor + to 5.

\* You can move the cursor according to the skipping units.

\* You can move the cursor continuously by holding down the key.

6. Press .

7. Use to move the cursor + to 7. Sewing points 5 to 7 will all now be selected.

8. Press .

9. Use the jog key to move the cursor + to 5', 6' and 7'.

10. Press .

The sewing points will move to the 5', 6' and 7' positions.

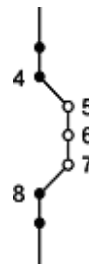

11. Carry out steps 6 and 7 in "Programming procedure" (page 19, 20).

## Deleting the first stitch to change the sewing start point to the second stitch

The following describes how to delete the sewing start point of a programmed pattern to make the second stitch as the sewing start point.

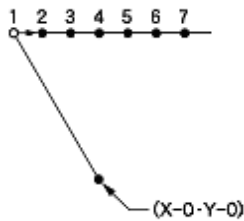

1. Carry out step 8 in "Programming procedure" (page 20).

2. Touch .

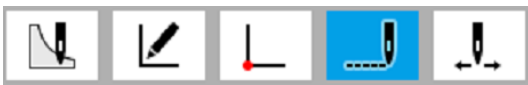

3. Touch .



4. Touch ◀ ▶ to select "Manual select".



5. Use ◀▶ to move the cursor + to 1.

\* You can move the cursor according to the skipping units.

\* You can move the cursor continuously by holding down the key.

6. When you press the ▲ key once, the sewing point will change to red and it will be selected.

7. Press .

The 1 at the white circle for the 1st stitch will be deleted, and the needle position for the sewing start point will move to the 2 for the 2nd stitch.

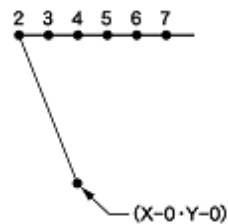

8. Carry out steps 6 and 7 in "Programming procedure" (page 19, 20).

## Moving the sewing start point

The following describes how to move the sewing start point from 1 to 1'.

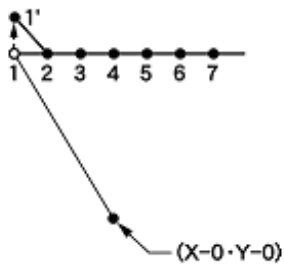

1. Carry out step 8 in "Programming procedure" (page 20).

2. Touch .

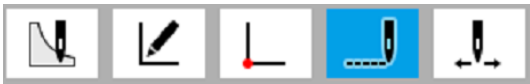

3. Touch .



4. Touch ◀ ▶ to select "Manual select".



5. Use ◀ ▶ to move the cursor + to 1.

\* You can move the cursor according to the skipping units.

\* You can move the cursor continuously by holding down the key.

6. When you press the  key once, the sewing point will change to red and it will be selected.

7. Press .

8. Use the jog key to move the cursor + to 1'.

9. Press .

The 1 at the white circle for the 1st stitch will move, and the needle position for the sewing start point will move to 1'.

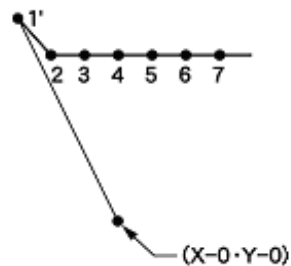

10. Carry out steps 6 and 7 in "Programming procedure" (page 19, 20).



### Adding a new sewing start point before the first stitch

A point is added before the current sewing start point to make it as the sewing start point. The following describes how to change the sewing start point from 1 to 1'.

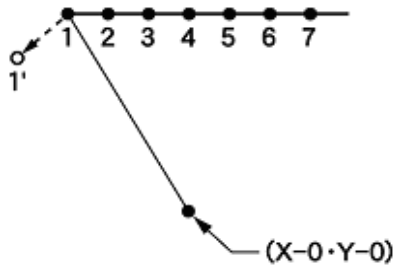

1. Carry out step 8 in "Programming procedure" (page 20).

2. Touch .

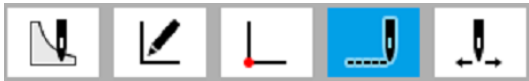

3. Touch .



4. Touch  to select "Add Automatically".



5. Use  to move the cursor + to 1.

6. Press .

\* You can move the cursor according to the skipping units.

\* You can move the cursor continuously by holding down the key.

A sewing point will be added to the outline between sewing points 1 and 2.

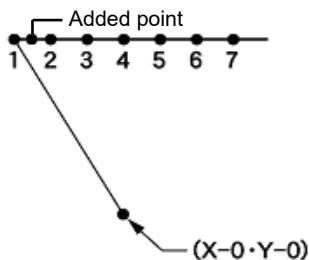

7. Touch .



8. Touch  to select "Manual select".



9. Use  to move the cursor + to 1.

10. When you press the  key once, the sewing point will change to red and it will be selected.

11. Press .

12. Use the jog key to move the cursor + to 1'.

13. Press .

The 1 at the 1st stitch will move, and the needle position for the sewing start point will move to 1'.

14. Repeat steps 9 to 13 to move the sewing point which was added in step 6 to position 1.

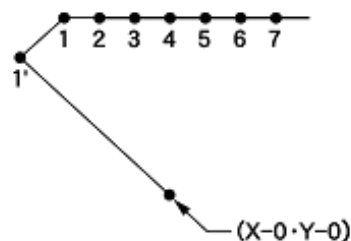

15. Carry out steps 6 and 7 in "Programming procedure" (page 19, 20).

## Adding an escape point before the sewing start point

The following describes how to set the escape point A before the sewing start point.

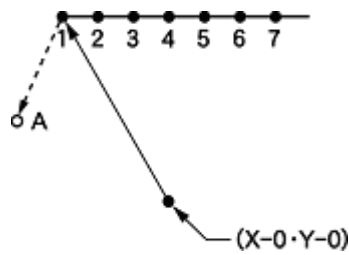

\* The escape point is a provisional point provided to preventing the work clamp from interfering with the needle or the presser foot when the work clamp is lifted at the start point.

1. Carry out step 8 in "Programming procedure" (page 20).

2. Touch .



3. Touch .

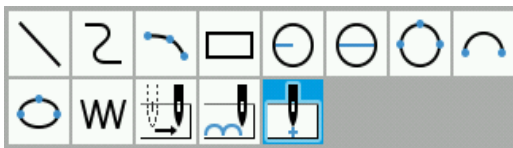

4. Use the jog key to move the cursor + to A.

5. Press .

The sewing start point at position 1 will be moved to position A. By shifting the position of the sewing start point, the point can be used as an escape point.

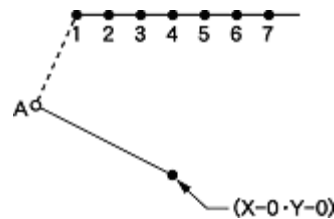

6. Carry out steps 6 and 7 in "Programming procedure" (page 19, 20).

### Modifying a pattern by moving a component point

This section describes how to change the outline component points in a pattern which has already been programmed.

This section describes how to modify a circle (A, B and C) so that it passes through the vertices of a triangle (D, E and F), using an actual program as an example.

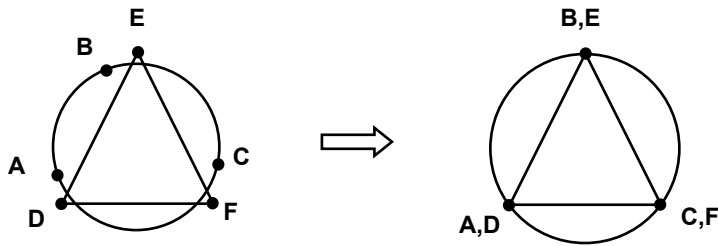

1. Carry out step 8 in "Programming procedure" (page 20).

2. Touch



3. Touch



4. Touch to select "Manual select".



5. Use to move the cursor + to A.

\* You can move the cursor continuously by holding down the key.

6. When you press the key once, the component point will change to red and it will be selected.

7. Press .

8. Use the jog key to move the cursor + to D.

9. Press .

Point A will move to position D.

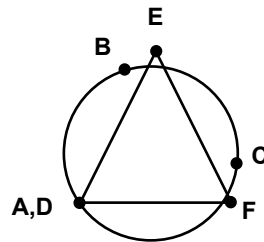

10. Repeat steps 8 and 9 to move B to E and C to F.

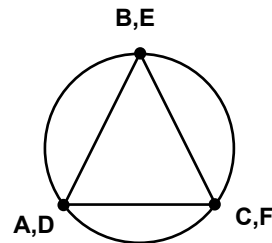

11. Carry out steps 6 and 7 in "Programming procedure" (page 19, 20).

### Modifying a pattern by adding a component point

This section describes how to add outline component points to a pattern which has already been programmed. This section describes how to modify a pattern by adding component point A' and adjusting the positions of A and A', using an actual program as an example.

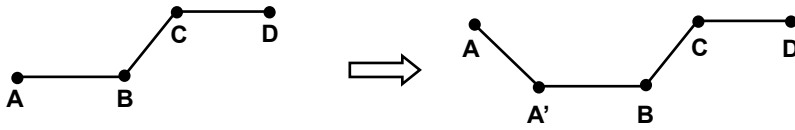

1. Carry out step 8 in "Programming procedure" (page 20).

2. Touch .



3. Touch .





4. Use  to move the cursor + to A.

5. Press .

\* You can move the cursor continuously by holding down the key.

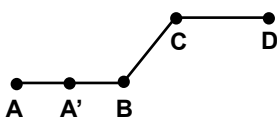
A component point A' will be added to the outline between component points A and B.



6. Touch .





7. Touch  to select "Manual select".



8. Use  to move the cursor + to A.

\* You can move the cursor continuously by holding down the key.

9. When you press the  key once, the component point will change to red and it will be selected.

10. Press .

11. Use the jog key to move the cursor + to A.

12. Press .

13. Repeat steps 8 to 11 to move component point A' which was added in step 5.

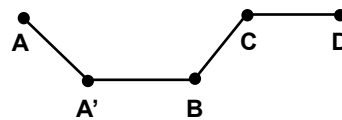

14. Carry out steps 6 and 7 in "Programming procedure" (page 19, 20).

## Modifying a pattern by deleting a component point

This section describes how to delete outline component points from a pattern which has already been programmed.

This section describes how to modify a pattern by deleting component point D, using the following program as an example.

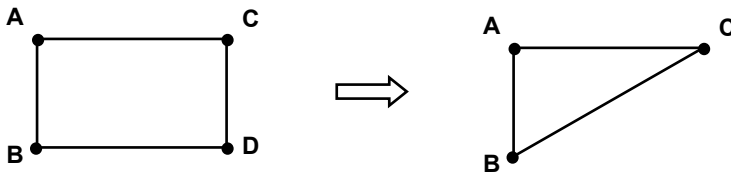

1. Carry out step 8 in "Programming procedure" (page 20).

2. Touch .





3. Touch .



4. Use  to move the cursor + to D.

\* You can move the cursor continuously by holding down the key.

5. When you press the  key once, the component point will change to red and it will be selected.

6. Press .

The selected component point will be deleted. The outline will be reconstructed so that the component points before and after the selected component point are joined together.

7. Carry out steps 6 and 7 in "Programming procedure" (page 19, 20).

### Moving the pattern in parallel

The following describes how to move the pattern in parallel when the first stitch is the sewing start point.

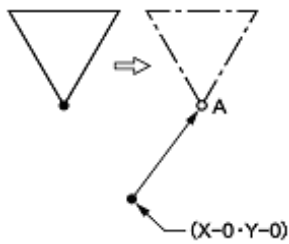



1. Carry out step 8 in "Programming procedure" (page 20).

2. Touch .

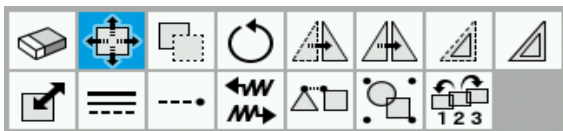

3. Touch .



4. Use  to position the cursor + at the outline which you would like to edit.

5. When you press the  key once, the outline will change to red lines and it will be selected.

6. Press .

7. Use the jog key to move the cursor + along the X-axis to position A.

8. Press .

The 1st stitch will move to position A.

9. Carry out steps 6 and 7 in "Programming procedure" (page 19, 20).

## Deleting a part of data during programming

The following describes how to delete 2 stitches (7 and 8) at point 8 and creating a new program.

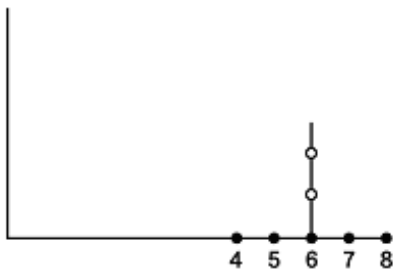

1. Touch  while programming.





2. Touch .



3. Touch  to select "Manual select".



4. Use  to move the cursor + to 8.
5. When you press the  key once, the sewing point will change to red and it will be selected.
6. Press . The sewing point at 8 will be deleted.

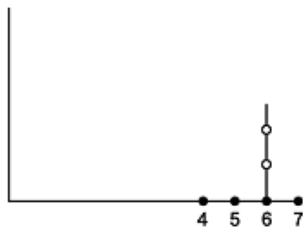

7. Repeat steps 4 to 6 to delete the sewing point at 7 also. The sewing point at 7 will be deleted and the cursor will move to 6.

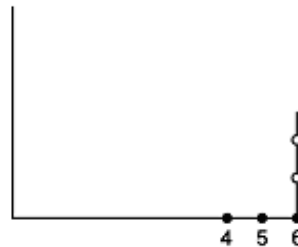

8. Continue programming.

### Moving a part of a continuous program in parallel

This section describes how to move part of a continuous program (patterns B and C) in parallel at the same time, using an actual program as an example.

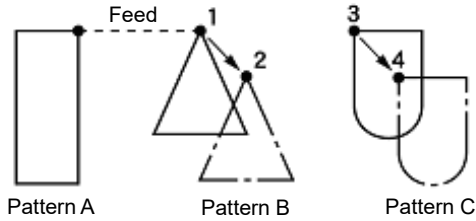



1. Carry out step 8 in "Programming procedure" (page 20).

2. Touch .

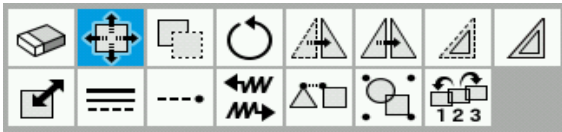

3. Touch .



4. Use  to position the cursor + at the outline of pattern B.

5. When you press the  key once, the outline will change to red lines and it will be selected.

6. Repeat steps 4 and 5 to select pattern C as well. Patterns B and C will now be selected.

7. Press .

8. Use the jog key to move the cursor + to 2.

9. Press .

Pattern B will move to 2, and the pattern C will move to 4 in the same way.

10. Carry out steps 6 and 7 in "Programming procedure" (page 19, 20).



### Moving a part of a continuous program in parallel partially

Move a part of a continuous program in parallel to the position before the next feed is started. The following describes how to move only pattern B in parallel.

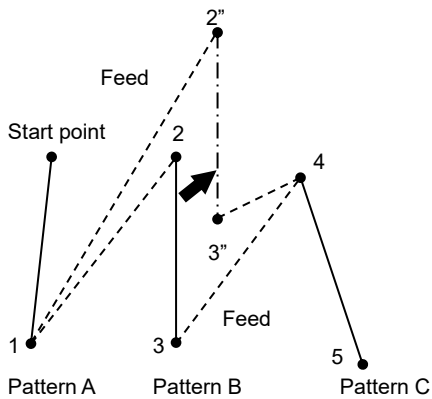



1. Carry out step 8 in "Programming procedure" (page 20).

2. Touch .

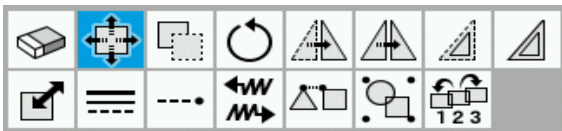

3. Touch .



4. Use  to position the cursor + at the outline of pattern B.



5. When you press the  key once, the outline will change to red lines and it will be selected.

6. Press .

7. Use the jog key to move the cursor + to 2".

8. Press .  
Pattern B will move to 2".

9. Carry out steps 6 and 7 in "Programming procedure" (page 19, 20).

To set parallel movement in the middle of stitch data, touch , and then touch , select the sewing points to move in parallel, and then move the sewing points.

The sewing points which are moved are connected by feeding.

(In the example given below, 6-3 which are in between 2 and 4 are moved to 6"-3".)

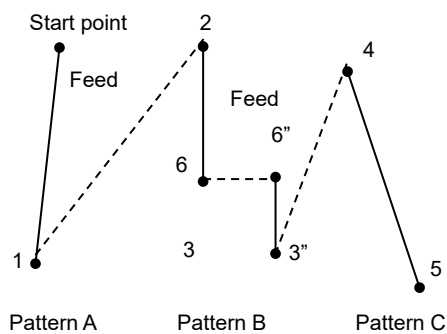

### Inserting a straight line into a pattern

This describes how to add a new pattern to an existing program or pattern which has already been created.

\* The procedure introduced here is the procedure when "Settings" -> "Programmer" -> "Consecutive Data Input" is set to "OFF".

1) When inserting a straight line before the selected pattern

[Before inserting straight line]



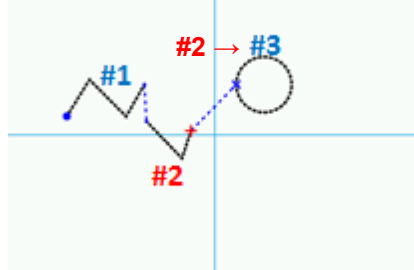

[After inserting straight line]





1. Touch .

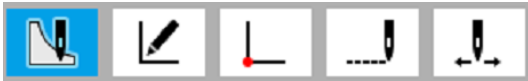

2. Use  to move the cursor + to outline #2.

3. Touch .



4. Touch .

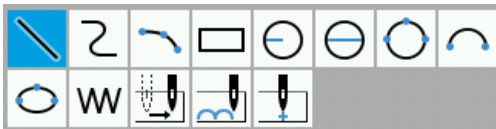

5. Touch  to select "Insert".



6. Use the jog key to move the cursor to the position where you would like to insert the pattern.

7. Press  to provisionally set the start point.

8. Use the jog key to move the cursor + to the position for the end point of the new pattern to be created.

9. Press  to provisionally set the sewing points.

\* Repeat steps 8 and 9 until the shape of the pattern has been created.

10. Press  to confirm the pattern.

- 2) When inserting a straight line after a selected component point  
 \* The above operation is only enabled for straight lines, curves and arcs.

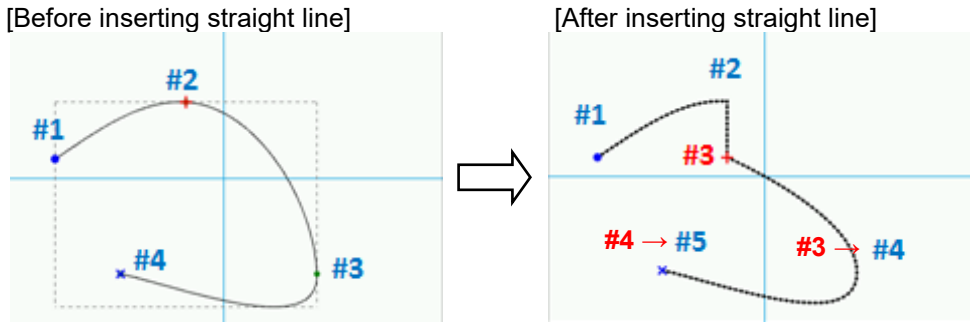



1. Touch .

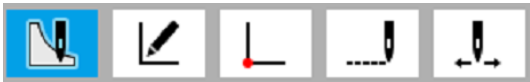

2. Use  to move the cursor + to #2.  
 \* You can move the cursor continuously by holding down the key.

3. Touch .



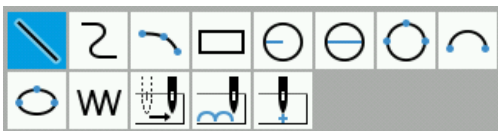

4. Touch .



5. Touch  to select "Insert".



6. Use the jog key to move the cursor to the position where you would like to insert the pattern.  
 7. Press  to provisionally set the start point.  
 8. Use the jog key to move the cursor + to the end point.  
 9. Press  to confirm the pattern.

### CHAPTER 3 PROGRAMMING PATTERNS

3) When inserting a line while drawing a circle

[Before inserting straight line]

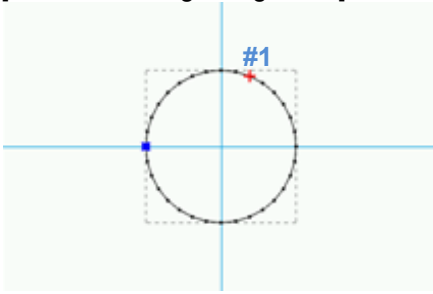

[After inserting straight line]

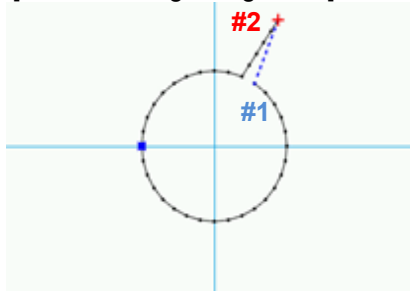

1. Touch .



2. Use  to move the cursor + to C.

\* You can move the cursor continuously by holding down the key.

3. Touch .

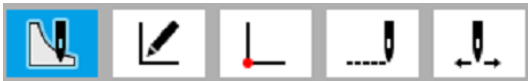

4. Touch .

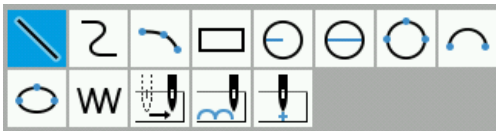

5. Touch  to select "Insert".



6. Use the jog key to move the cursor to #1.

7. Press  to provisionally set the start point.

8. Use the jog key to move the cursor + to the position for the end point of the new pattern to be created.

9. Press  to provisionally set the sewing points.

\* Repeat steps 8 and 9 until the shape of the pattern has been created.

10. Press  to confirm the pattern.

# **Chapter 4**

## **Extended Option Output (Program)**

**Foreword**

**Function of the extended option output**

You can register programs to control various pressing motions and automatic stacking of sewn products in the sewing machine for any purpose.





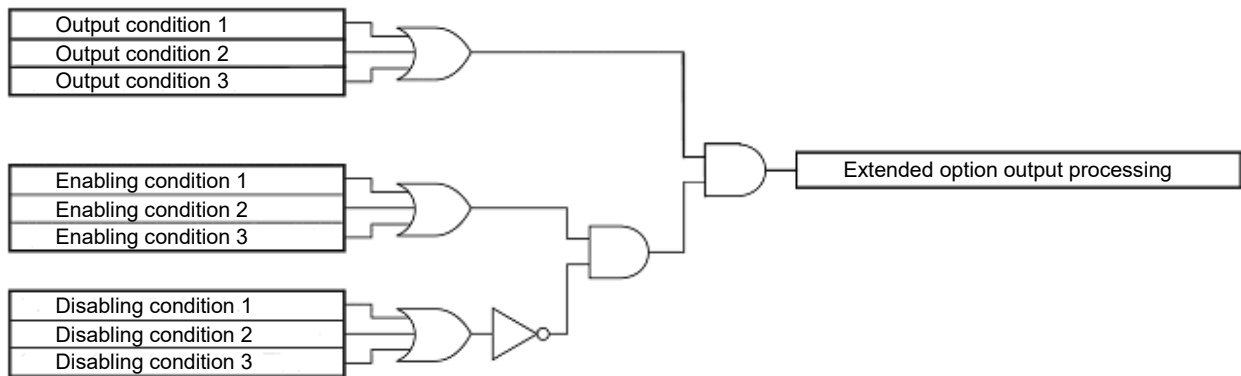

- \* Programs from earlier models (BAS300E/F/G/H series) cannot be used by the BAS300J series.
- \* Operation for the extended option output is for the experienced. Since it includes complicated operations, you are recommended to receive training before using this function. For information on the training, contact an engineer who have received training or store where you purchased your sewing machine.

Only when 3 conditions, i.e. output conditions, enabling conditions and disabling conditions (three items for each), are established, the extended option output is executed.



The relationship between the output and the conditions is as follows:



**Description of icons**

	Creates the content for extended option output.
	Deletes the extended option output program which is being edited.
	Saves the extended option output onto media.
	Saves the extended option output onto media with a different name. * This is not displayed when "Single SEQ file mode" in "Programmer" is set to "ON". Refer to Chapter 6 for details on changing the setting.
	Reading the extended option output data saved in the media.
	Opens the setting screen.
	Loads extended option output programs from the sewing machine.

## CHAPTER 4 EXTENDED OPTION OUTPUT (PROGRAM)

	<p>Sets the extended option output program which is being displayed into the sewing machine.</p> <p>* This is not displayed when "Single SEQ file mode" in "Programmer" is set to "ON". Refer to Chapter 6 for details on changing the setting.</p>
	<p>Deletes extended option output programs from the sewing machine.</p>

## Setting extended option output

### Opening the extended option output setting screen

Follow the procedure given below to display the extended option output settings.

1. Touch **+** on the programming screen.
2. A dialog box is displayed for you to select the type of file to create.
3. Select "New Extended Option Program", and then touch **OK**.

The extended option output settings will open.

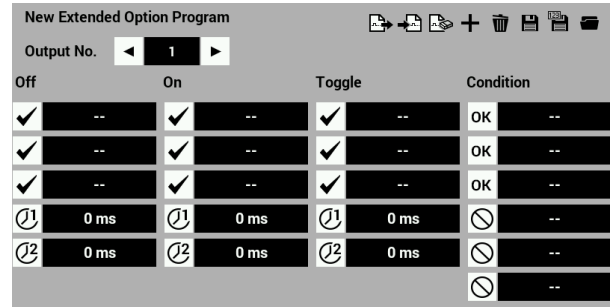

- \* When "Starting extended option editing directly" in "Programmer" is set to "ON", touch in the Home screen to display the extended option output setting screen.

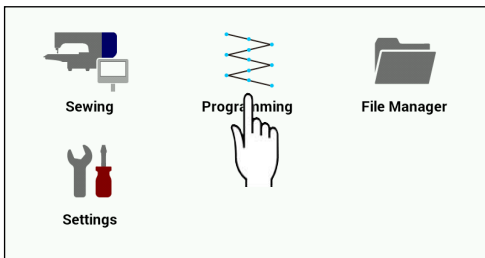

### Setting details of the extended option output

Specifying a value at the items below.

- **Extended option output No.**  
Use ◀ ▶ to specify a single output number from 1 to 24.  
\* Refer to "Table of extended option output" (page 88).
- **✓ Output conditions**  
Enter the extended option output conditions. You can enter up to three conditions: Off, On or Toggle.  
\* Refer to "Table of extended option output" (page 90).
- **⌚ Timer 1**  
Set a time until the output is switched after the output condition is established.  
Set 0 or any value between 10 and 2550 ms by increments of 10 ms.
- **⌚ Timer 2**  
Set duration of the extended option output.  
Set 0 or any value between 10 and 2550 ms by increments of 10 ms.  
If you set 0, the switched output status is kept.



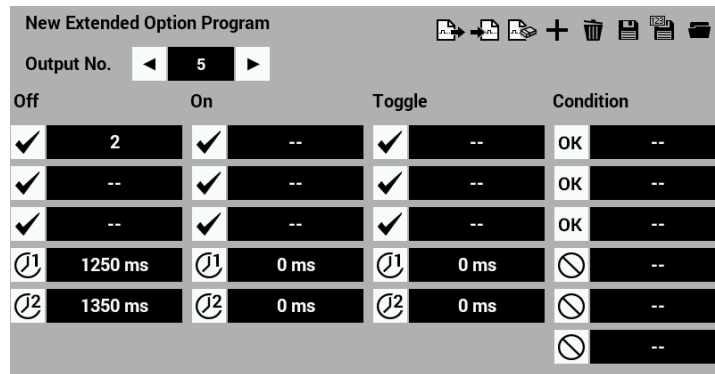

- \* To clear the setting value, unselect the condition check box and then select "Spare" in the screen.
- \* The setting details will be saved in the sewing machine (in the panel internal memory). Refer to "Applying extended option output to the sewing machine" on page 84.

## Setting enabling conditions

The following conditions can be set.

- OK **Enabling conditions**  
 3 conditions can be specified.  
 \* Refer to "Table of condition number" (page 85)
- ⊘ **Disabling conditions**  
 Up to three disabling conditions can be entered.

- \* Refer to "Table of condition number" (page 85).
- \* If enabling conditions are not set, it is always in the enabled status. To use the extended option output conditions without changing any, do not set any value as enabling conditions.
- \* To clear the setting value, select "Spare" in the conditions screen.

## Saving extended option output

The extended option output created by the programmer can be saved into the panel internal memory.

1. Touch .



### 【When saving a new program】

The save screen will open, so select the extended option output program number.

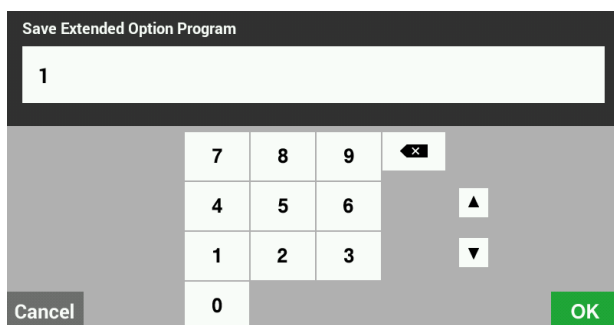

2. Touch OK.

The extended option output will be saved and the display will return to the extended option output settings.

- \* If you do not want to save the extended option output, touch Cancel to return to the extended option output settings.
- \* Up to a maximum of 99 extended option outputs can be saved in the panel internal memory. In addition, the setting data can be written to external storage media (SD card or USB media).

## CHAPTER 4 EXTENDED OPTION OUTPUT (PROGRAM)

### 【 When overwriting an existing program number】

- The program saving dialog screen will open, so touch **Yes** to overwrite the existing file.  
Touch **No** to return to the extended option output settings.

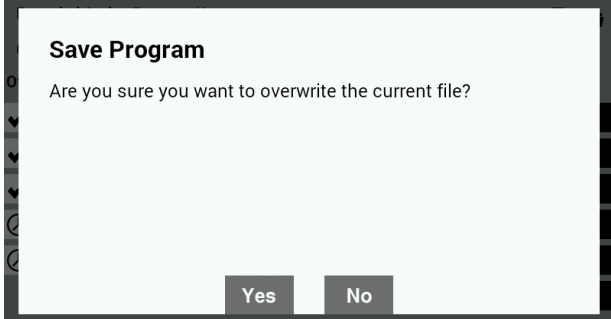

- \* The save screen is not displayed when "Single SEQ file mode" in "Programmer" is set to "ON". Furthermore, during single SEQ file mode, a confirmation screen is displayed asking if you would like to apply the extended option output settings to the sewing machine immediately after saving them.

### Saving with a different filename

The extended option output created by the programmer can be saved into the panel internal memory with a different name.

- Touch .  
\* This is not displayed when "Single SEQ file mode" in "Programmer" is set to "ON".



The save screen will open, so enter an extended option output program number which is not yet being used.

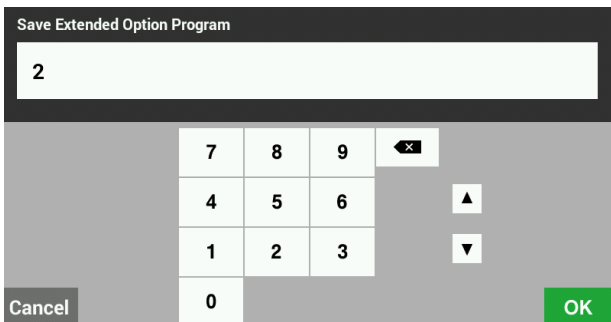

- Touch **OK**.  
The extended option output will be saved under the different name and the display will return to the extended option output settings.

If you would like to overwrite an existing program number, enter an existing extended option output program number at the save screen in step 1.

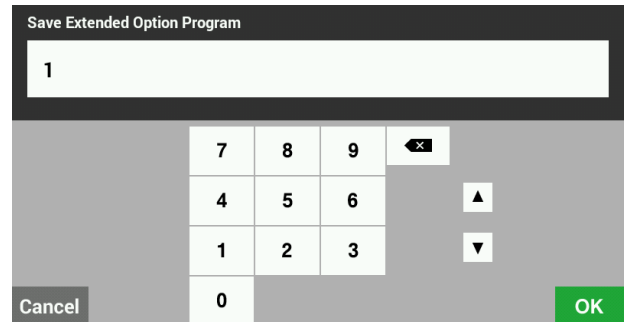

A saving confirmation dialog screen will be displayed, so touch **Yes** to overwrite the existing file.

Touch **No** to return to the extended option output settings.

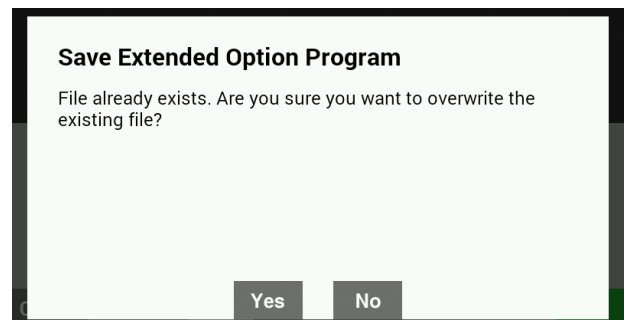

## Loading extended option output which has been created

You can load extended option output from the media (panel internal memory, SD card or USB media) where it has been stored.

1. Connect the media which contains the extended option output which you would like to load.

\* When loading a program which has been saved in the panel internal memory, this operation is not required.

2. Touch .

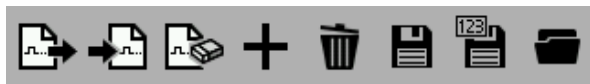

3. The File Manager will open, so select the media and destination which contain the extended option output which you would like to load.

4. Select the extended option output which you would like to load.

5. Touch **OK**.

The extended option output will be loaded and the display will return to the extended option output settings. (This operation does not register the extended option output in the sewing machine's memory.)

\* If you do not want to load the extended option output, touch **Cancel** to return to the extended option output settings.

\* Refer to "Importing files from storage media into the panel internal memory" in "Chapter 5 - File Manager Functions" (page 122) for details on how to import extended option output into the sewing machine.

6. SEQ files which have been created by connecting the BPD3000 programmer to a BAS311G are given the filename "ISMSEQ00.SEQ". Because the "ISMSEQ00.SEQ" file cannot be read by the LCD panel, use a PC to change the name to "ISMSEQ01.SEQ" so that it can be read by the LCD panel.

## Deleting extended option output

You can delete extended option output which is being edited.

1. Touch .

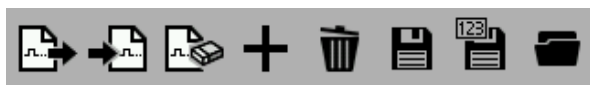

2. A confirmation screen will be displayed for you to confirm if it is okay to delete the contents which are being edited.

3. Touch **Yes**.

The contents which are currently being edited will be deleted, and the display will return to the extended option output settings.

\* To delete extended option output which has been saved in external media (panel internal memory, SD card or USB media), delete the extended option output file which is saved on the storage media while referring to "Deleting files and folders" in the File Manager Functions (page 117).

## Applying extended option output to the sewing machine

### Applying extended option output to the sewing machine

---

This explains how to load and apply the extended option output to the sewing machine.

1. Save the extended option output or load extended option output that has already been created.
2. At the extended option setting screen, touch .

\* This is not displayed when "Single SEQ file mode" in "Programmer" is set to "ON".

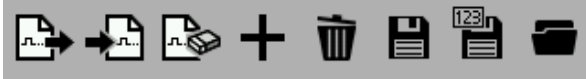



3. A confirmation screen will be displayed.
4. Touch .
5. The extended option output settings will be applied to the sewing machine.

### Displaying extended option output

---



This explains how to display the extended option output which has been applied to the sewing machine.

1. At the extended option setting screen, touch .
2. A confirmation screen will be displayed.
3. Touch .
4. The extended option output setting screen will be refreshed.

### Initializing extended option output

---

This explains how to initialize the extended option output which has been applied to the sewing machine.

1. At the extended option setting screen, touch .
2. A confirmation screen will be displayed for you to confirm if it is okay to initialize the content which has been applied.
3. Touch .
4. The extended option output which has been applied will be deleted from to the sewing machine and the setting will be initialized.

## Table of condition number

The following shows the output condition numbers, enabling condition numbers and disabling condition numbers, and operations to establish them.

### Mode for operating the sewing machine

Condition No.	Operation to establish the condition
1	After a feed is complete at the home position
2	After a feed is complete at the sewing start point (at escape point, if applicable)
3	Before sewing or a test feed starts from the sewing start point (or the escape point)
4	Before the upper shaft of the sewing machine starts rotating at the first stitch
5	Before a test feed starts at the first stitch
6	After sewing or a test is complete (before moving to the sewing start or escape point)
7	After an emergency stop is reset
8	After a step back starts
9	Before halfway sewing starts
10	After the lower thread counter value changes from 1 to 0 and the lower thread replacement wait state starts.
11	After the lower thread replacement wait state ends
12	After a program starts
13	After a program ends
14	When trigger data is detected during sewing
15	After an emergency stop occurs
16	After a thread breakage is detected
17	After a program is changed
18	After the power switch is turned on
19	After a low air pressure error is detected
20	Before moving to the next start point on completion of sewing in the split mode
21	After moving to the next start point on completion of sewing in the split mode

### Standard input

Condition No.	Operation to establish the condition
25	When the foot pedal is enabled (before the work clamp moves up or down)
26	When the start pedal is enabled (before starting operation)

### Standard output

Condition No.	Operation to establish the condition
30	After the work clamp rises (after the right work clamp rises for the air type)
31	After the work clamp lowers
32	After the left work clamp rises (only for the air type)
33	After the left work clamp lowers (only for the air type)
34	After the intermittent work clamp rises
35	After the intermittent work clamp lowers
36	After the wiper output is turned off
37	After the thread breaking output is turned off
38	Before the work clamp rises

## CHAPTER 4 EXTENDED OPTION OUTPUT (PROGRAM)

### External input of the extended option

Condition No.	Operation to establish the condition
40	When extended option input 1 is turned on
41	When extended option input 1 is turned off
42	When extended option input 2 is turned on
43	When extended option input 2 is turned off
44	When extended option input 3 is turned on
45	When extended option input 3 is turned off
46	When extended option input 4 is turned on
47	When extended option input 4 is turned off
48	When extended option input 5 is turned on
49	When extended option input 5 is turned off
50	When extended option input 6 is turned on
51	When extended option input 6 is turned off
52	When extended option input 7 is turned on
53	When extended option input 7 is turned off
54	When extended option input 8 is turned on
55	When extended option input 8 is turned off
56	When extended option input 9 is turned on
57	When extended option input 9 is turned off
58	When extended option input 10 is turned on
59	When extended option input 10 is turned off
60	When extended option input 11 is turned on
61	When extended option input 11 is turned off
62	When extended option input 12 is turned on
63	When extended option input 12 is turned off
64	When extended option input 13 is turned on
65	When extended option input 13 is turned off
66	When extended option input 14 is turned on
67	When extended option input 14 is turned off
140	When extended option input 17 is turned on
141	When extended option input 17 is turned off
142	When extended option input 18 is turned on
143	When extended option input 18 is turned off

### Extended option output

Condition No.	Operation to establish the condition
70	When extended option output 1 is turned on
71	When extended option output 1 is turned off
72	When extended option output 2 is turned on
73	When extended option output 2 is turned off
74	When extended option output 3 is turned on
75	When extended option output 3 is turned off
76	When extended option output 4 is turned on
77	When extended option output 4 is turned off
78	When extended option output 5 is turned on
79	When extended option output 5 is turned off
80	When extended option output 6 is turned on
81	When extended option output 6 is turned off
82	When extended option output 7 is turned on
83	When extended option output 7 is turned off
84	When extended option output 8 is turned on
85	When extended option output 8 is turned off
86	When extended option output 9 is turned on
87	When extended option output 9 is turned off
88	When extended option output 10 is turned on
89	When extended option output 10 is turned off
90	When extended option output 11 is turned on
91	When extended option output 11 is turned off
92	When extended option output 12 is turned on
93	When extended option output 12 is turned off
94	When extended option output 13 is turned on
95	When extended option output 13 is turned off
96	When extended option output 14 is turned on
97	When extended option output 14 is turned off
98	When extended option output 15 is turned on
99	When extended option output 15 is turned off
100	When extended option output 16 is turned on
101	When extended option output 16 is turned off
102	When extended option output 17 is turned on
103	When extended option output 17 is turned off
104	When extended option output 18 is turned on
105	When extended option output 18 is turned off
106	When extended option output 19 is turned on
107	When extended option output 19 is turned off

## CHAPTER 4 EXTENDED OPTION OUTPUT (PROGRAM)

108	When extended option output 20 is turned on	113	When extended option output 22 is turned off
109	When extended option output 20 is turned off	114	When extended option output 23 is turned on
110	When extended option output 21 is turned on	115	When extended option output 23 is turned off
111	When extended option output 21 is turned off	116	When extended option output 24 is turned on
112	When extended option output 22 is turned on	117	When extended option output 24 is turned off

**Table of extended option input**

Extended option input No.	Combined input (conditions) <sup>*1</sup>		Connector <sup>*2</sup>			
	Name	Use condition	Connector No.	Pin No.		
				Signal	+24V	OV
1	EJECT RIGHT SENSOR	Memory switch No. 560 = Other than 0	P10 (EXIN1)	2	3	1
2	EJECT LEFT SENSOR			5	6	4
3	RESET SW	MEMORY SW650=2		8	9	7
	MOVEMENT SW	MEMORY SW253=2				
4				11	12	10
5			14	15	13	
6	PNo Input bit0	MEMORY SW354=1,2 MEMORY SW355=ON	P11 (EXIN2)	2	3	1
7	PNo Input bit1			5	6	4
8	PNo Input bit2			8	9	7
9	PNo Input bit3			11	12	10
10	PNo Input bit4			14	15	13
11	Start disallowed signal	MEMORY SW569=1,2,3	P34 (EXIN3)	2	5	1
12				3		
13	AIR SW	MEMORY SW558=ON	P35 (EXOUT1)	12	11	9
14			P8 (SENSOR1)	11	10	12
17			P44	5	4	6
18			(EXIN4)	2	1	3

**CHAPTER 4 EXTENDED OPTION OUTPUT (PROGRAM)**

**Table of extended option output**

Extended option output No.	Combined input (conditions) <sup>*1</sup>		Connector <sup>*2</sup>			
	Name	Use condition	Connector No.	Pin No.		
				Signal	+24V	
1	2-STEP THREAD TENSION DEVICE	MEMORY SW564 ON	P35 (EXOUT1)	5	10	
2	AIR WIPER	MEMORY SW557=2		6		
3	AUTO EJECT	MEMORY SW560=1,2,3		7		
4	RIGHT WORK CLAMP FLIP/FLOP	MEMORY SW055=1,2	P12 (AIR2)	1	9	
	PNo output bit0	MEMORY SW951=ON				
5	LEFT WORK CLAMP FLIP/FLOP	MEMORY SW055=1,2		2		
	PNo output bit1					
6	PNo output bit2	MEMORY SW951=ON		3		10
7	PNo output bit3			4		
8				5		
9	SIGNAL TOWER GREEN	MEMORY SW559=ON		6		
10	SIGNAL TOWER YELLOW		7			
11	SIGNAL TOWER RED		8			
12	NEEDLE COOLER	MEMORY SW550=ON	P35 (EXOUT1)	8	10	
13	Inner clamp device or lower thread detector	MEMORY SW556=1,2,3 MEMORY SW569=1,2,3		4		
14	Inner clamp device	MSW65=ON		3		
15	LCLAMP	When 2 stage work clamp is used		2		
16	RCLAMP	For the air type	1			
17			P13 (AIR3)	1	5	
18				2		
19				3		
20			4			
21			P45 (EXOUT3)	1	5	
22				2		
23				3		6
24			4			

**\*1 Use this output when an optional part is mounted.  
It is not available as the extended option I/O if conditions are established.**

**\*2 Connector numbers and pin numbers on the control board in the control box.**



## Examples of the extended option output

To program the extended option output, prepare the timing chart. Then, set output conditions and enabling/disabling conditions based on the chart.

The following examples describe how to develop program setting values based on the timing chart.

\* No explanation of the operation of the sewing machine is provided.

### ■ Example 1

#### Sequence 1 for stacker

This sequence ejects material immediately after the work clamp rises on completion of sewing, and programs stacking operation.

Option output 4	BAR1: For holding material
Option output 5	BAR2: For moving material
Option output 6	AIR: For air blow

#### Timing chart

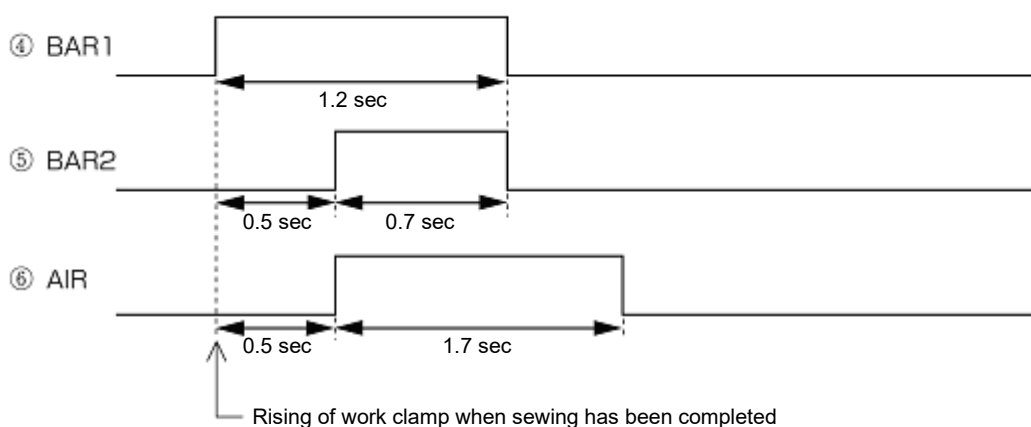

#### Program setting values

Output No.	Operation setting	Output condition		Timer 1 [ms]	Timer 2 [ms]	Enabling conditions <input checked="" type="checkbox"/>		Disabling conditions <input checked="" type="checkbox"/>	
		Condition No.	Content			Condition No.	Content	Condition No.	Content
4	ON	30	Rising of work clamp	0	1200	6	End of sewing	81	Output 6 OFF
5	ON	76	Output 4 ON	500	700	—	—	—	—
6	ON	76	Output 4 ON	500	1700	—	—	—	—

## CHAPTER 4 EXTENDED OPTION OUTPUT (PROGRAM)

### ■ Example 2

#### Sequence 2 for stacker

This sequence ejects material immediately after the work clamp rises on completion of sewing, and programs stacking operation.

Option output 3	UP/DW: Rising/lowering for removing material
Option output 4	MOVE: Movement for removing material
Option output 5	BAR1: For holding material
Option output 6	BAR2: For moving material

#### Timing chart

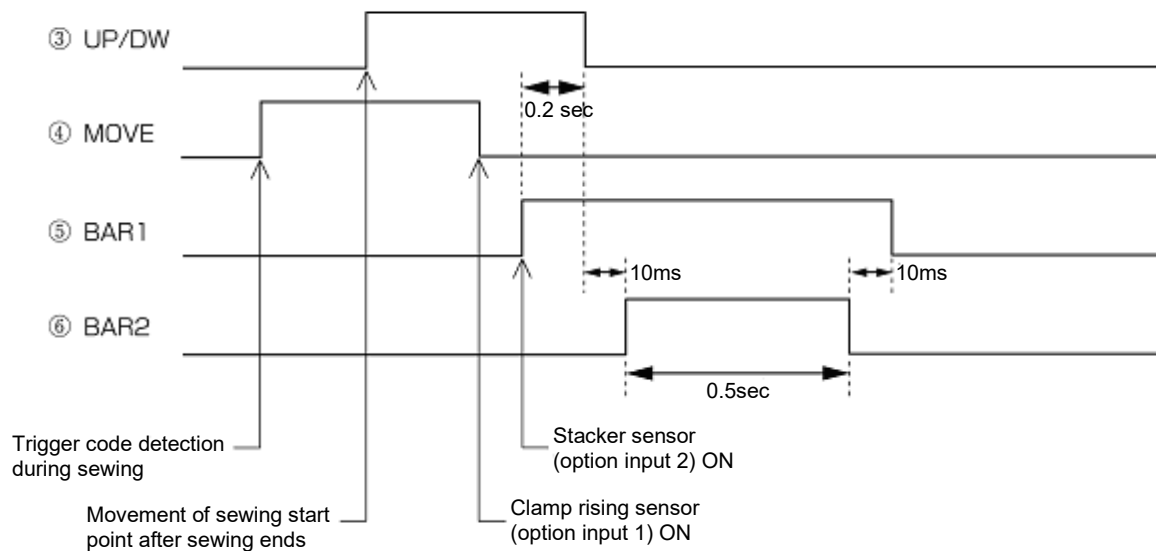

#### Program setting values

Output No.	Operation setting	Output condition		Timer 1 [ms]	Timer 2 [ms]	Enabling conditions <input type="checkbox"/>		Disabling conditions <input checked="" type="checkbox"/>	
		Condition No.	Content			Condition No.	Content	Condition No.	Content
3	ON	2	Movement of sewing start point	0	0	6	End of sewing	1	Sewing machine returns to home position
	OFF	78	Output 5 ON	200	0				
4	ON	14	Trigger detection	0	0	-	-	-	-
	OFF	40	Input 1 ON	0	0				
5	ON	42	Input 2 ON	0	0	-	-	-	-
	OFF	81	Output 6 OFF	10	0				
6	ON	75	Output 3 OFF	10	500	-	-	-	-

■ Example 3

Signals for external equipment

When connecting to the external sequence unit, this sequence programs operations to issue timing signals.

Option output 4	READY: Ready-for-sewing signal
Option output 5	END: Sewing end signal
Option output 6	THBK: Thread breakage detection signal

Timing chart

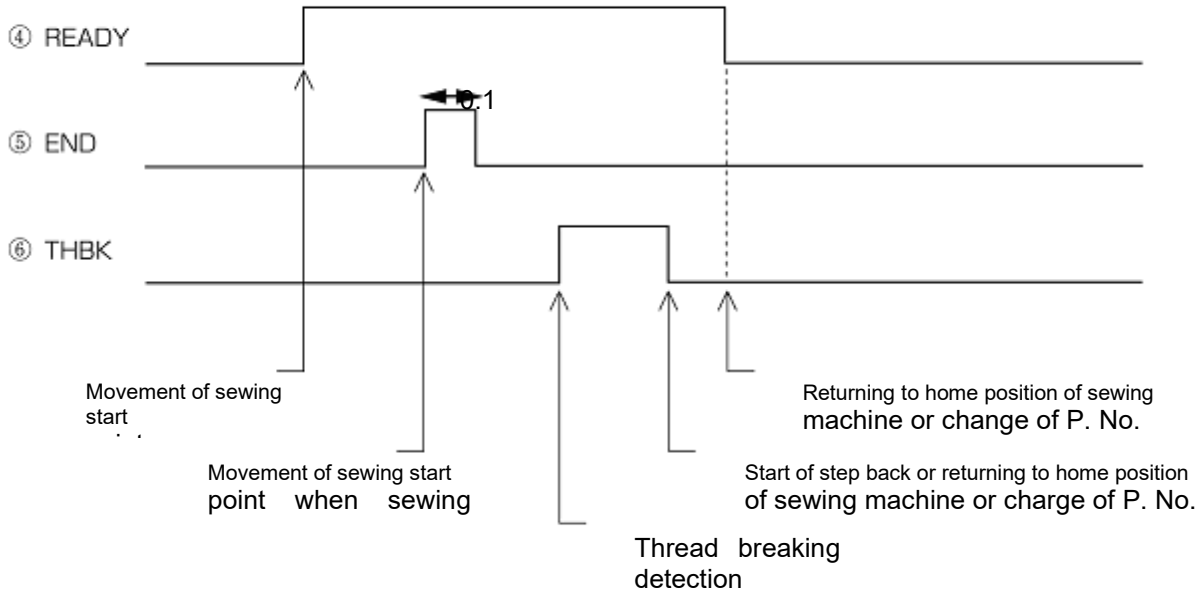

Program setting values

Output No.	Operation setting	Output condition		Timer 1 [ms]	Timer 2 [ms]	Enabling conditions <input type="checkbox"/>		Disabling conditions <input type="checkbox"/>	
		Condition No.	Content			Condition No.	Content	Condition No.	Content
4	ON	2	Movement of sewing start point	0	0				
	OFF	1	Sewing machine returns to home position	0	0	-	-	-	-
17		Change of P. No.							
5	ON	2	Movement of sewing start point	0	100	6	End of sewing	1	Sewing machine returns to home position
6	ON	16	Thread breakage detection	0	0	-	-	-	-
	OFF	8	Start of step back	0	0				
		77	Output 4 OFF						

## Use of extended option output (Basics)

This section provides a comprehensive description of how to use the extended option output by providing a range of examples so that many users will be able to use it easily. The examples show programs that can be tried and tested only with an air-type sewing machine.

### Necessary items

BAS-342JS

Sewing machine service manual (Refer to this for details on the memory switch setting method.)

### Simplified examples of the extended option output

Programming No. 1 to No. 20 is possible as option outputs; No. 15 is for the air valve output of the left work clamp and No. 16 is for the air valve output of the right work clamp. If outputs No. 15 and 16 are programmed as option output, the work clamp will not function as originally programmed, but will function as programmed as option output. The examples show how to program option outputs No. 15 and 16 to confirm their operation (acceptable if the left and right work clamps function as programmed).

#### Caution

One example shows how to sew with the work clamp raised. Please be careful when attempting it. Be sure to remove the needle before confirming its operation.

### ■ Turning the output interlocking on and off corresponding to sewing machine operations

Create a program to automatically raise and lower the left work clamp (option output No. 15 ON and OFF) at the sewing start point.

1. Have the programmer at hand, and follow the instructions given in "Opening the extended option output setting screen" (refer to page 80) to display the output settings.
2. Referring to the table of sewing machine operation mode condition numbers (refer to page 85), set "ON when condition No. 2 (on completion of movement to the sewing start point) is established". Set Timer 2 to 1 sec. (1000 ms). On the setting screen, make the following settings.

Off	On	Toggle	Condition
<input checked="" type="checkbox"/>	<input checked="" type="checkbox"/>	<input checked="" type="checkbox"/>	OK
--	2	--	--
<input checked="" type="checkbox"/>	<input checked="" type="checkbox"/>	<input checked="" type="checkbox"/>	OK
--	--	--	--
<input checked="" type="checkbox"/>	<input checked="" type="checkbox"/>	<input checked="" type="checkbox"/>	OK
--	--	--	--
			<input type="checkbox"/>
0 ms	0 ms	0 ms	--
			<input type="checkbox"/>
0 ms	1000 ms	0 ms	--
			<input type="checkbox"/>
			--

Select condition No. 2, and then touch **OK**.

After the setting is input, the numeric value in the column of the extended option output setting screen will be refreshed, so that you can check if the value has been input correctly.

3. Touch
4. Save the settings in the panel internal memory, and then touch **OK**.

5. Display the extended option output settings once more, and then touch  to apply the extended option output which was saved in step 5 to the sewing machine.
6. Read short sewing data of approximately 10 stitches. Set the memory switch No. 50 to 4 (the work clamp is not are automatically raised when sewing is completed). Carry out sewing operation. Confirm that the left work clamp is in the raised position, that it stays in that position for one second, and then lowers whenever the needle returns to the sewing start point. If the left work clamp operates in this manner, it is operating in accordance with the program.

### ■ Modifying programmed data

Modify existing program data according to the procedure described in "Turning the output interlocking on and off corresponding to sewing machine operations".

1. Display the extended option output settings.
2. Touch .  
Load the programs which have already been written.



3. Display the output setting screen. Set Timer 1 to 0.5 sec. (500 ms) and Timer 2 to 0.5 sec. (500 ms). On the setting screen, make the following settings.

New Extended Option Program					
Output No. ◀ 15 ▶					
Off	On	Toggle	Condition		
✓	--	✓ 2	✓	--	OK --
✓	--	✓ --	✓	--	OK --
✓	--	✓ --	✓	--	OK --
⌚	0 ms	⌚ 500 ms	⌚	0 ms	⊘ --
⌚	0 ms	⌚ 500 ms	⌚	0 ms	⊘ --
					⊘ --

The existing "1000" setting for timer 2 will be refreshed and overwritten with "500".

4. Carry out steps 4 to 6 in "Turning the output interlocking on and off corresponding to sewing machine operations" to overwrite the extended option output.
5. Carry out sewing operation. Confirm that the time that elapses after the needle returns to the sewing start point until the left work clamp rises is longer (since the setting for Timer 1 has been changed from 0 to 0.5 sec.), and that the length of time the work clamp takes to rise is less (since the setting for Timer 2 has been changed from 1 to 0.5 sec.).

## CHAPTER 4 EXTENDED OPTION OUTPUT (PROGRAM)

### ■ Individually programming on and off

In the examples of "Turning the output interlocking on and off corresponding to sewing machine operations" and "Modifying data you programmed once", a procedure was described outlining how to create a program to keep the output on state for a time set for Timer 2, and return it to the off state automatically.

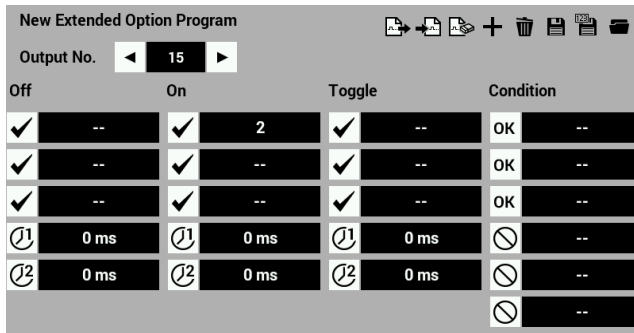

In this example, create a program to automatically open the left work clamp at the sewing start point (option output No. 15 ON) and close it simultaneously when the machine starts. (option output NO. 15 OFF). Confirm that on and off output conditions are different.

1. Have the programmer at hand and display the output settings.
2. Referring to the table of sewing machine operation mode condition numbers (refer to page 85), set "ON when condition No. 2 is established (on completion of movement to the sewing start point)".  
On the setting screen, make the following settings.

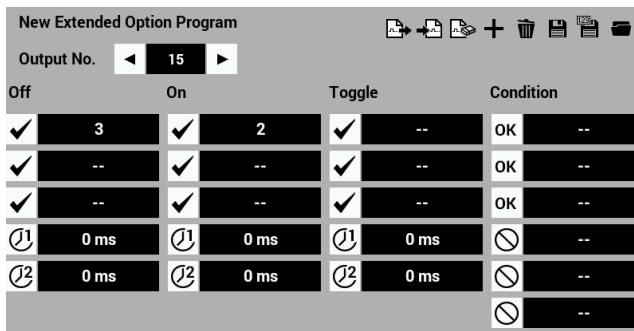

3. Referring to the "Mode for operating the sewing machine" table of condition numbers (refer to page 85), set to "off when condition No. 3 (before sewing start) is established".  
Enter into the setting screen as shown below.



4. Touch  to save the extended option output.
5. Display the extended option output settings once more, and then touch  to apply the extended option output which was saved in step 4 to the sewing machine.
6. Carry out sewing operation. Confirm that the left work clamp rises after the needle returns to the sewing start point and it lowers when sewing begins.  
As shown in the above example, when Timer 2 is set to [0000], the on or off state will remain unchanged after the condition is established.

### ■ Using trigger data to turn the output on while sewing

In the "Individually programming on and off" example, No. 15 was programmed to turn on at the sewing start point. In this example, the setting is changed so that it turns on during sewing. Do not change the off setting at the sewing start which was set in the "Individually programming on and off" example.

1. Touch .

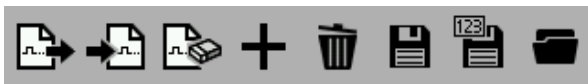

Load the programs which have already been written.

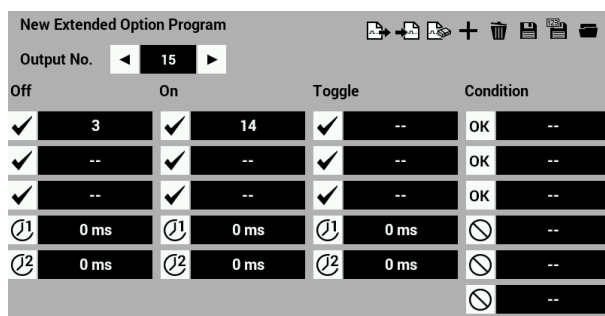

2. Referring to the table of sewing machine operation mode condition numbers (refer to page 85), set "ON when condition No. 14 (trigger data detection) is established".  
On the setting screen, overwrite the values as follows.



Check that the data which was set in "Individually programming on and off" still remains.

3. Touch  to overwrite the extended option output.
4. Display the extended option output settings once more.  
Touch  to apply the extended option output which was overwritten in step 3 to the sewing machine.
5. Load the sewing program for editing, and add a code at the desired position. ("Adding and deleting codes at sewing points" in "Chapter 3 - Programming with icons" (page 47))  
At the code editing screen, specify "Not paused" for option output No. 15. Enter into the setting screen as follows.

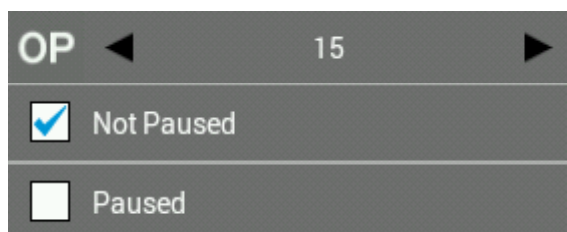

6. After adding the code, save the sewing program under a new program number.
7. Carry out sewing.  
Check that the left work clamp rises at the position where the code was added, and that it drops when sewing starts.

## CHAPTER 4 EXTENDED OPTION OUTPUT (PROGRAM)

### ■ Sequence output

This assumes that the option output is for the stacker (a device that ejects material after sewing is complete). It creates an example of sequence output after the work clamp rises when sewing ends.

First, make the settings for option output No. 15 so that it turns on and off corresponding to the raising of the work clamp. Next, set No. 16 so that it turns on and off, and then add the condition at the end of sewing as explained in the section below.

1. Have the programmer at hand and display the output settings.
2. Referring to the table of condition numbers of the standard output (refer to page 85), set output condition No. 15 to "ON when condition No. 30 is established (after the work clamp rises)". Set Timer 2 to 1.2 sec. (1200 ms).

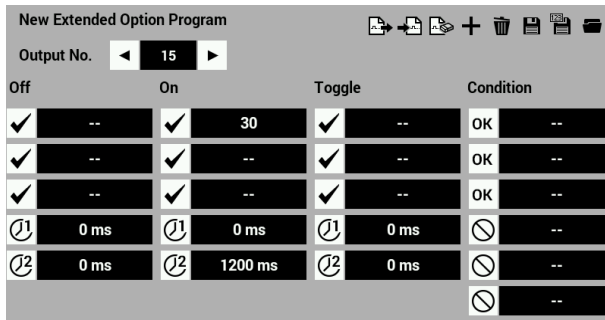

Enter the following in the extended option output settings.

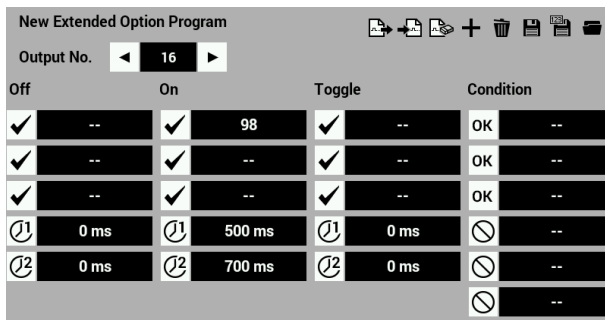

3. Referring to the table of condition numbers of the extended option output (refer to page 86), set the output condition for No. 16 to "condition No. 98 (when No. 15 is turned on)". Set Timer 1 to 0.5 sec. (500 ms) and Timer 2 to 0.7 sec. (700 ms).

On the setting screen, make the following settings.



4. Touch  to overwrite the extended option output.
5. Display the extended option output settings once more. Touch  to apply the extended option output which was overwritten in step 4 to the sewing machine.
6. Carry out sewing operation. Set the memory switch No. 50 to 3 (the work clamps are automatically raised when sewing is completed) to carry out sewing operation. Confirm that the left work clamp (No. 15) is turned on and right work clamp (No. 16) is turned on after a 0.5 sec. delay and both are turned off in 0.7 sec. corresponding with the raising of the work clamps (in this example, the right and left work clamps operate as option outputs).

Depress the foot pedal to confirm that No. 15 and 16 are turned on and off. When restarting, confirm that the intermittent clamp is at the lowered position.

In sequence output mode (outputs are continuously turned on and off), it can be useful to specify the first output that turns on as the output condition for sewing machine operation. Then specify the moments when the first output turns on or off as the output condition for subsequent outputs.



## ■ Adding enabling (AND) conditions to the sequence output

In the example in the previous section, option outputs No. 15 and 16 are turned on and off even when you depress the foot pedal.

In this section, add enabling conditions to allow the output to be turned on and off only when sewing is finished.



1. Touch .

Load the programs which have already been written.



2. Referring to the "Mode for operating the sewing machine" table of condition numbers (refer to page 85), set the enabling condition for No. 15 to "Enable  setting when condition No. 6 (after sewing ends) is established". Set it to "Disable  setting (condition No. 101 in the "Table of condition number" on page 86) when output No. 16, which ends output of a continuous sequence is turned off".

New Extended Option Program					
Output No. ◀ 15 ▶					
Off	On	Toggle		Condition	
<input checked="" type="checkbox"/>	--	<input checked="" type="checkbox"/>	30	<input checked="" type="checkbox"/>	OK 6
<input checked="" type="checkbox"/>	--	<input checked="" type="checkbox"/>	--	<input checked="" type="checkbox"/>	OK --
<input checked="" type="checkbox"/>	--	<input checked="" type="checkbox"/>	--	<input checked="" type="checkbox"/>	OK --
<input type="radio"/>	0 ms	<input type="radio"/>	0 ms	<input type="radio"/>	101
<input type="radio"/>	0 ms	<input type="radio"/>	1200 ms	<input type="radio"/>	--
				<input type="radio"/>	--

3. Touch  to overwrite the extended option output.  
If an enabling condition has been set, the disabled status is the initial setting.
4. Display the extended option output once more, and then touch  to apply the extended option output which was overwritten in step 3 to the sewing machine.
5. Read sewing data to carry out sewing operation.  
Confirm that the left and right work clamps (option outputs No. 15 and 16) do not operate when the foot pedal is depressed, but they are turned on and off corresponding with the raising of the work clamps when sewing is completed. (Confirm that the intermittent clamp is at the lowered position. Depress the start switch.)

If you set "enabling  as the enabling condition", you usually need to set "disabling  as well.

In the above example, set an enabling (AND) condition at the first output No. which is to be turned on and off. Then, set the condition number for the last on or off for the sequence as the disabling condition.

If you do not set any enabling conditions as in the previous examples, outputs are turned on and off according to the settings made on the output setting screen.

### Use of extended option output (Application)

On the precondition that a checking board is created, this section describes how to create programs by providing some examples.

#### Necessary items (other than for Basics)

---

Checking board (refer to "Reference material" pages 107 - 108.)

#### Limitations of extended option output

---

- If the number of output points exceeds 24(including work clamp output, etc.)
- If the number of output points exceeds 16
- Input check during sewing machine operation is disabled. Therefore, on and off operation of the output detected by input from the foot switch pedal while sewing is not possible.
- Sequence output during sewing machine operation is disabled.  
On and off operation of the output by inputting trigger data out of sewing data is enabled.  
Temporarily pausing the sewing machine to run the extended option output by inputting trigger data is enabled. (Input and output are enabled in this case.)
- Disabled when many AND conditions are set. For example, operation by switching among multiple modes and inhibition of output by combining multiple inputs are disabled.  
Up to 2 input AND conditions can be set for each option output. Configuration of 3 input AND conditions is enabled by setting one output as a virtual output. (Refer to "Examples of option outputs" on page 92, 99.)
- Control of the incorporated stepper motor output by the extended option output is disabled.

## Examples of option outputs (Application)



### ■ Automating the commencement of sewing

If you set memory switch No. 950 to ON, sewing automatically commences after turning on option output No. 1.

1. Create a program to make the machine commence sewing after the work clamp lowers.

1. Change the memory switches to the following settings.  
No.50=4, No.57=ON, No.950=ON
2. Have the programmer at hand and display the output settings.  
If any extended option output exists which has already been registered, delete it first.
3. Referring to the "Standard output" table of condition numbers (refer to page 85), set the output condition for No. 1 to "on when condition No. 31 (after the work clamp lowers) is established", and set Timer 2 to 100 ms. Enter the following in the extended option output settings.

New Extended Option Program					
Output No. ◀ 1 ▶					
Off	On	Toggle	Condition		
✓ --	✓ 31	✓ --	OK	--	
✓ --	✓ --	✓ --	OK	--	
✓ --	✓ --	✓ --	OK	--	
⌚ 0 ms	⌚ 0 ms	⌚ 0 ms	⊘	--	
⌚ 0 ms	⌚ 100 ms	⌚ 0 ms	⊘	--	
			⊘	--	

4. Touch  to write the extended option output.
5. Display the extended option output settings once more.  
Touch  to apply the extended option output which was written in step 4 to the sewing machine.
6. Read the sewing data. Depress the start pedal. The sewing machine detects the home position and moves to the sewing start point. Though depressing the start pedal usually starts sewing operation, it will not when memory switch No. 950 is set to ON. Depress the foot pedal twice to raise and lower the work clamp. Confirm that sewing commences after the foot pedal has reached the lowered position.

## CHAPTER 4 EXTENDED OPTION OUTPUT (PROGRAM)

### ■ Controlling commencement of sewing by providing an input check to the automatic start function

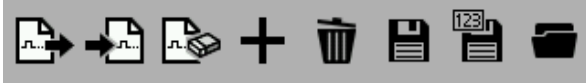

Add option input No. 1 to the enabling conditions in the previous section.

1. Touch  and load the programs which have already been written.



2. Display the enabling condition setting screen. Referring to the table of external input condition numbers (refer to page 86), set enabling condition No. 1 to “enabling  OK when condition No. 40 (input 1 ON) is established”. Set “disabling  when condition No. 41 (input 1 OFF) is established”.

New Extended Option Program					
Output No. <input type="text" value="1"/>					
Off	On	Toggle	Condition		
<input checked="" type="checkbox"/>	--	<input checked="" type="checkbox"/>	31	<input checked="" type="checkbox"/>	OK 40
<input checked="" type="checkbox"/>	--	<input checked="" type="checkbox"/>	--	<input checked="" type="checkbox"/>	OK --
<input checked="" type="checkbox"/>	--	<input checked="" type="checkbox"/>	--	<input checked="" type="checkbox"/>	OK --
<input checked="" type="checkbox"/>	0 ms	<input checked="" type="checkbox"/>	0 ms	<input checked="" type="checkbox"/>	0 ms <input type="checkbox"/> 41
<input checked="" type="checkbox"/>	0 ms	<input checked="" type="checkbox"/>	100 ms	<input checked="" type="checkbox"/>	0 ms <input type="checkbox"/> --
				<input checked="" type="checkbox"/>	--

3. Touch  to overwrite the extended option output.
4. Display the extended option output once more, and then touch  to apply the extended option output which was overwritten in step 3 to the sewing machine.
5. As an additional step 7 in "Automating the commencement of sewing", confirm also that sewing commences only when option input No. 1 is on.

By carrying out sequence control of the raising and lowering of the work clamp using the option output as shown in the example above, you can configure the sewing machine so that material is automatically loaded before sewing.

**■ Adding input check to carry out settings of 3-input AND conditions**

This example adds "when option inputs No. 1 and 2 are on" to the enabling conditions in the previous example of "Controlling commencement of sewing by providing an input check to the automatic start function". "After the work clamp is lowered (condition No. 31)" has been set as the output condition. Accordingly, a total of 3-input AND conditions are set.

Up to 2-input AND conditions can be set for each option output. 3-input AND conditions are configured so that one output is set to be virtual output.

In this case, set option output No. 2 as virtual output.

1. Touch  and load the programs which have already been written.

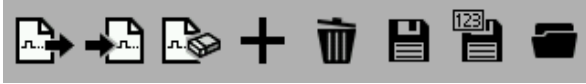

2. Display the extended option output settings.  
Referring to the "Extended option output" table of condition numbers (refer to page 86), set the enabling condition for No. 1 to "Enable  OK" setting when condition No. 72 (output 2 on) is established". Set "Disable  when condition No. 73 (output 2 off) is established".

New Extended Option Program

Output No.

Off	On	Toggle	Condition
<input checked="" type="checkbox"/> --	<input checked="" type="checkbox"/> 31	<input checked="" type="checkbox"/> --	OK 72
<input checked="" type="checkbox"/> --	<input checked="" type="checkbox"/> --	<input checked="" type="checkbox"/> --	OK --
<input checked="" type="checkbox"/> --	<input checked="" type="checkbox"/> --	<input checked="" type="checkbox"/> --	OK --
<input type="radio"/> 0 ms	<input type="radio"/> 0 ms	<input type="radio"/> 0 ms	<input type="radio"/> 73
<input type="radio"/> 0 ms	<input type="radio"/> 100 ms	<input type="radio"/> 0 ms	<input type="radio"/> --
			<input type="radio"/> --

3. Referring to the "External input of the extended option" table of condition numbers (refer to page 86), set the enabling condition for No. 2 to "Enable setting when condition No. 40 (input 1 on) is established". Enter into the setting screen as follows.

New Extended Option Program

Output No.

Off	On	Toggle	Condition
<input checked="" type="checkbox"/> --	<input checked="" type="checkbox"/> 40	<input checked="" type="checkbox"/> --	OK --
<input checked="" type="checkbox"/> --	<input checked="" type="checkbox"/> --	<input checked="" type="checkbox"/> --	OK --
<input checked="" type="checkbox"/> --	<input checked="" type="checkbox"/> --	<input checked="" type="checkbox"/> --	OK --
<input type="radio"/> 0 ms	<input type="radio"/> 0 ms	<input type="radio"/> 0 ms	<input type="radio"/> --
<input type="radio"/> 0 ms	<input type="radio"/> 0 ms	<input type="radio"/> 0 ms	<input type="radio"/> --
			<input type="radio"/> --

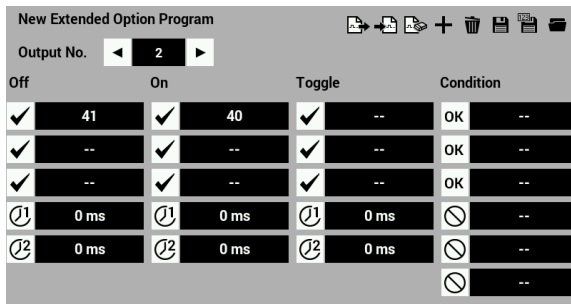

## CHAPTER 4 EXTENDED OPTION OUTPUT (PROGRAM)

4. Referring to the "External input of the extended option" table of condition numbers (refer to page 86), set the output off condition for No. 2 to "off when condition No. 41 (input 1 off) is established". Enter into the setting screen as follows.

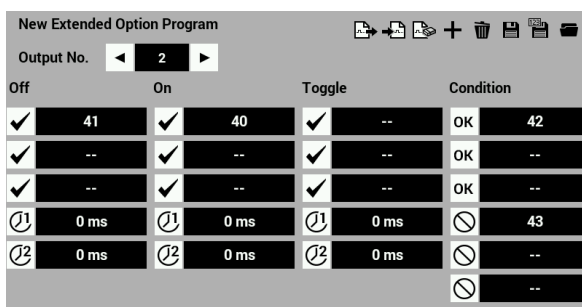

5. Referring to the "External input of the extended option" table of condition numbers (refer to page 86), set the enabling condition for No. 2 to "Enable  setting when condition No. 42 (input 2 on) is established". Set "Disable  when condition No. 43 (input 2 off) is established".



6. Touch  to overwrite the extended option output.
7. Display the extended option output once more, and then touch  to apply the extended option output which was overwritten in step 6 to the sewing machine.
8. Confirm that sewing commences as the work clamp lowers when both option inputs No. 1 and 2 are ON. In the example above, the output condition for virtual output No. 2 on is condition No. 40 (input 1 on). If input 1 is already on when the power is turned on, virtual output No. 2 will not turn on.

### ■ Temporary pause during sequence operation

Program Example 1 from the instruction manual. Confirm the option output during temporary pause.

1. Use  to delete the registered extended option output.
2. Referring to Example 1 (Sequence 1 for the stacker) in the programmer instruction manual (refer to page 89), program outputs of No. 4, 5, and 6 and enabling conditions for No. 4.
3. When the program is working as intended, press the temporary pause switch during the sequence operation to cancel it.  
Operating temporary pause during sequence operation temporarily pauses the sequence. To complete the sequence, carry out a restore operation.
4. Add condition No. 15 (when the sewing machine enters the temporary pause state), as conditions for output No. 4, 5, and 6 OFF.  
If you press the temporary pause switch, the output is immediately turned off.

## How to create programs

### ■ Selecting hardware on the output side

Use NPN open collector outputs.

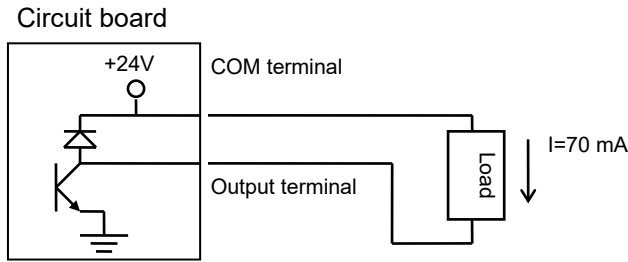

It is assumed that an optionally available air valve is used. In addition to a 24 V air valve, use a 24 VDC relay.

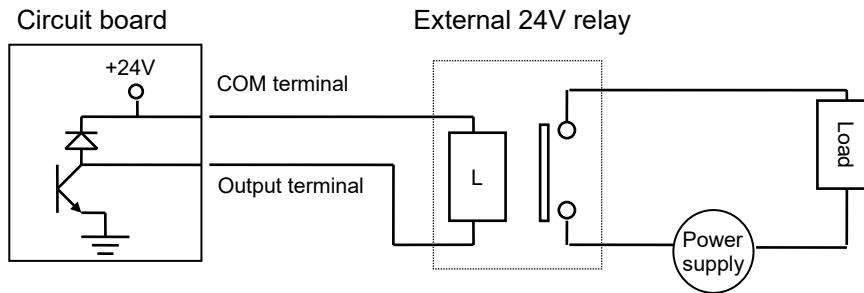

Fuses are not incorporated into the output circuit. To prevent the circuit from being damaged if the output short-circuits, it is recommended that you mount an external fuse for each circuit.

### ■ Selecting hardware on the input side

- Use non-isolated IC inputs

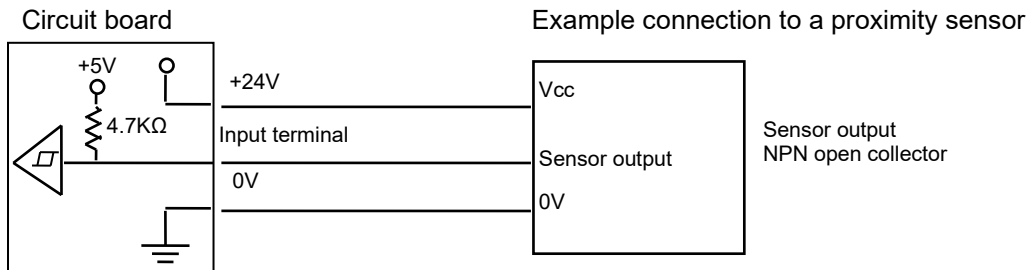

- In addition to using a contact switch or a 24 V sensor, use relays to isolate inputs.

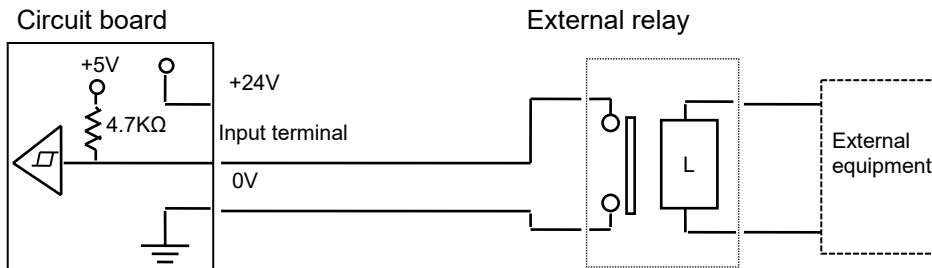

- Use relays for an electronic circuit with a min. application load of 5 V and 1 mA or less.



■ **Creating an I/O allocation table**

Allocate the selected hardware to complete the table.

Table of option output

Option output No.	Allocation		Connector		
	Name	Description	Connector No.	Pin No.	
				Signal	+24V
1			P35 (EXOUT1)	5	10
2				6	
3				7	11
4			P12 (AIR2)	1	9
5				2	
6				3	
7				4	
8				5	
9				6	
10				7	
11				8	
12			P35 (EXOUT1)	8	10
13				4	
14				3	
15				2	
16			1	11	
17			P13 (AIR3)	1	5
18				2	
19				3	
20				4	
21			P45 (EXOUT3)	1	5
22				2	
23				3	
24				4	

Table of option input

Option input No.	Allocation		Connector			
	Name	Description	Connector No.	Pin No.		
				Signal	+24V	0V
1			P10 (EXIN1)	2	3	1
2				5	6	4
3				8	9	7
4				11	12	10
5				14	15	13
6			P11 (EXIN2)	2	3	1
7				5	6	4
8				8	9	7
9				11	12	10
10			14	15	13	
11			P34 (EXIN3)	2	5	1
12				3		
13			P35 (EXOUT1)	12	11	9
14			P8 (SENSOR1)	11	10	12
17			P44 (EXIN4)	5	4	6
18				2	1	3

## CHAPTER 4 EXTENDED OPTION OUTPUT (PROGRAM)

### ■ Creating a timing chart and table of program setting values

Refer to three examples in pages 89 to 91.

1. Create a timing chart where on and off operations of input and output are shown in sequence of order of operation.
2. Tabulate the program setting values based on the timing chart and table of condition numbers (Refer to pages on 85).
3. Input values by using the programmer.

## Use of extended option output (Reference material)

Appendix

### Parts for the extended option

- P35 EXOUT1 connector  
For option outputs 1 to 3 and 12 to 16  
For option input 13  
12-pin connector of NH series from J.S.T. Mfg Co., Ltd.
- Housing for P12 AIR 2 connector  
For option output 4 to 11  
10-pin connector of NH series from J.S.T. Mfg Co., Ltd.
- Housing for P13 AIR 3 connector  
For option output 17 to 20  
5-pin connector of NH series from J.S.T. Mfg Co., Ltd.
- Housing for P45 EXOUT3 connector  
For option output 21 - 24  
J.S.T. Mfg. Co., Ltd. NH Series 6-pin.

#### Parts for the extended option input

- Housing and pin for P10 EXIN 1 connector  
Option input 1 to 5  
16-pin connector of PHD series from J.S.T. Mfg Co., Ltd.
- Housing and pin for P11 EXIN 2 connector  
Option input 6 to 10  
18-pin connector of PHD series from J.S.T. Mfg Co., Ltd.
- Housing and pin for P34 EXIN 3 connector  
Option input 11 to 12  
5-pin connector of PH series from J.S.T. Mfg Co., Ltd.
- Housing and pin for P8 SENSOR 1 connector  
Option input 14  
12-pin connector of PAD series from J.S.T. Mfg Co., Ltd.
- Housing pin for P44 EXIN4 connector  
Option input 17 - 18  
J.S.T. Mfg. Co., Ltd. PH Series 6-pin.

Circuit diagram of the checking board

BAS-360H, BAS-365H, BAS-370H, BAS-375H.

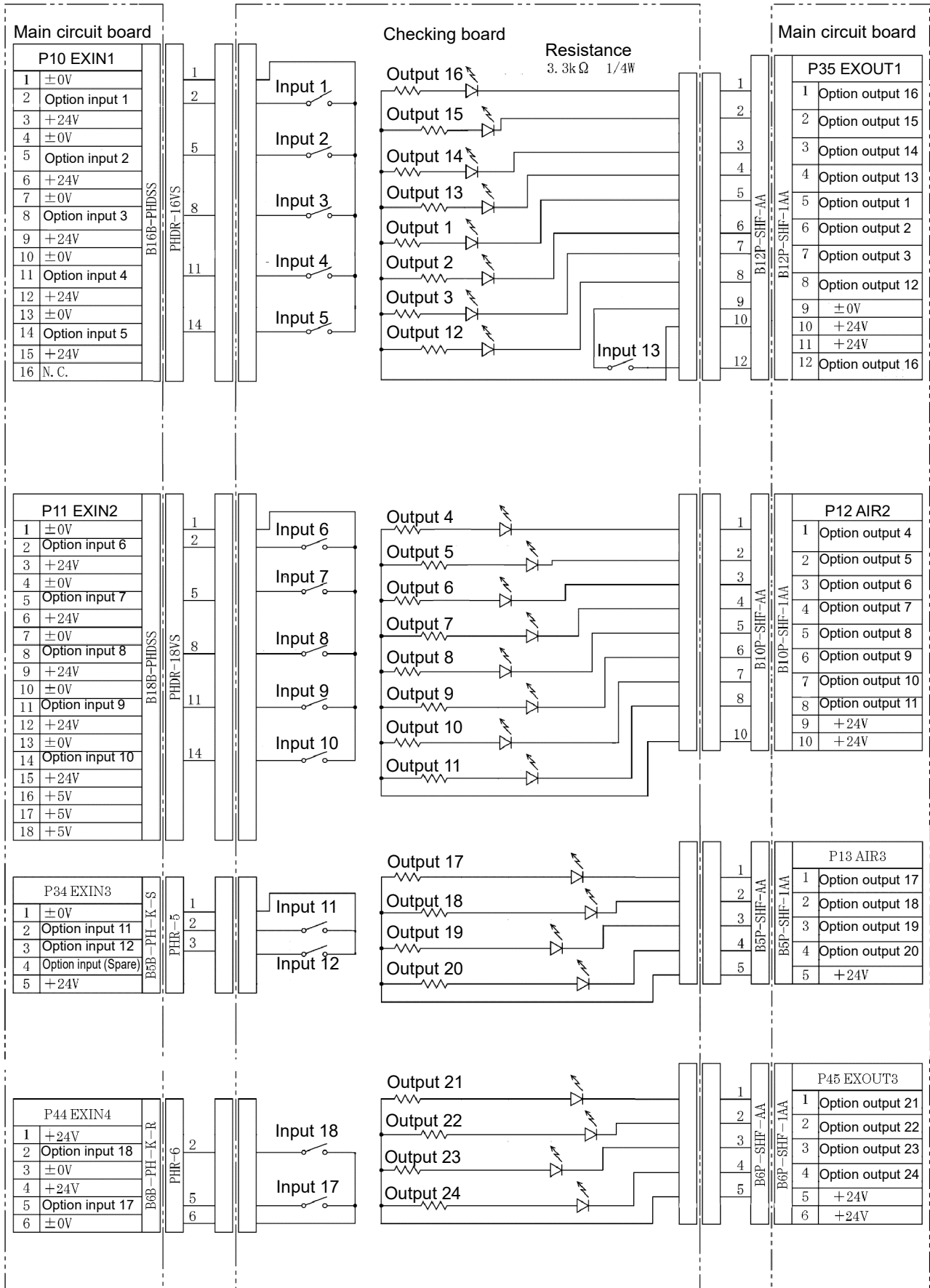

Option input 14 is a connector shared with the home position sensor signal. It is not used on the checking board.

**Block diagram**

Connector layout of the main circuit board

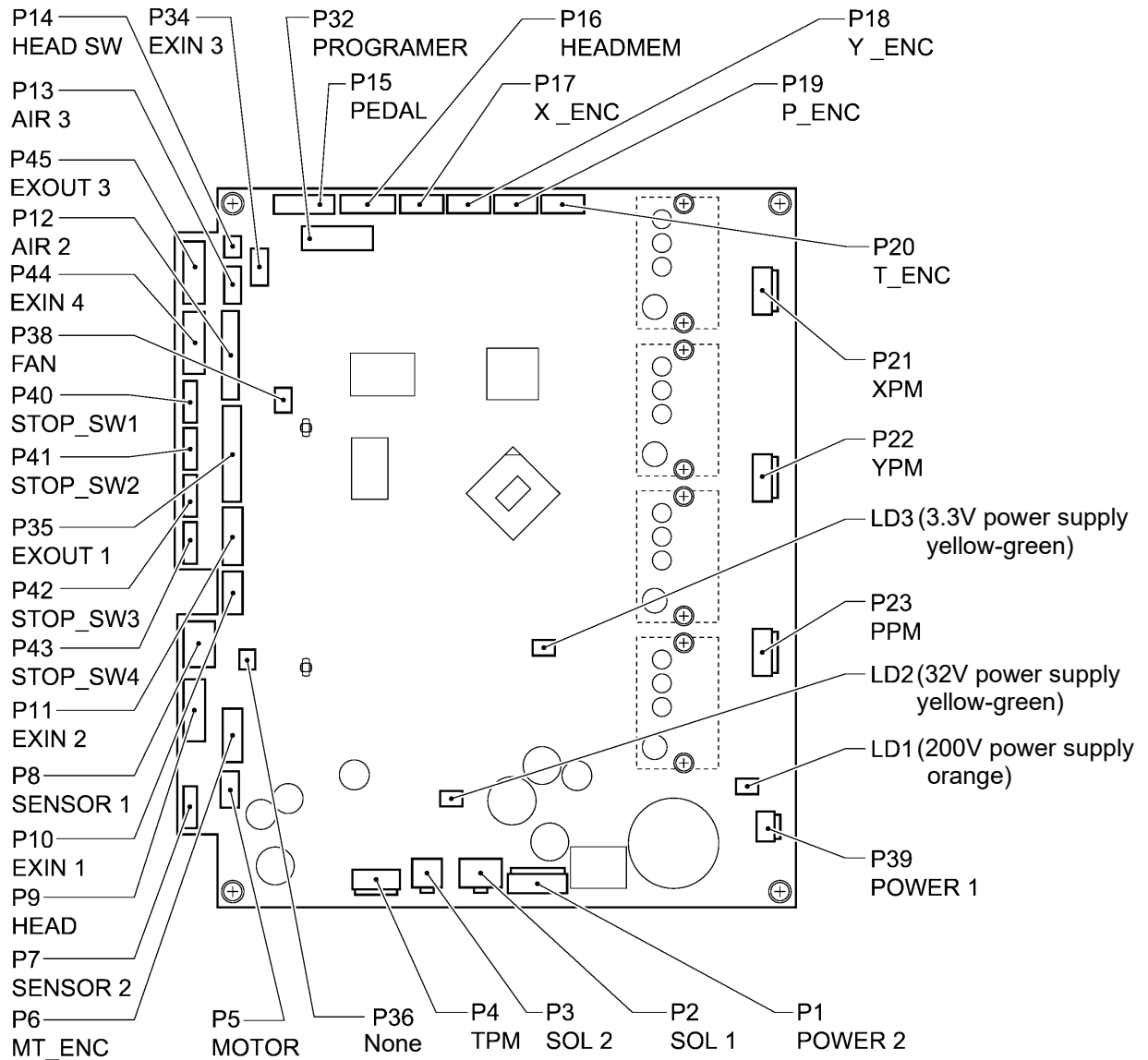

4168B

# **Chapter 5**

## **File Manager Functions**

**Foreword**

**Tasks that can be carried out using the File Manager**

This chapter describes how to use the File Manager.

The File Manager can be used to carry out the following tasks for files which are saved in the panel internal memory or on storage media.

- Checking file information
- File operations such as loading, deleting and copying files and changing filenames
- Reading files from and writing files to storage media

Furthermore, the following file formats (extensions) can be handled by the programmer.

(Files other than those given below can be displayed and selected, but operations on these files are restricted to changing filenames, copying and moving.)



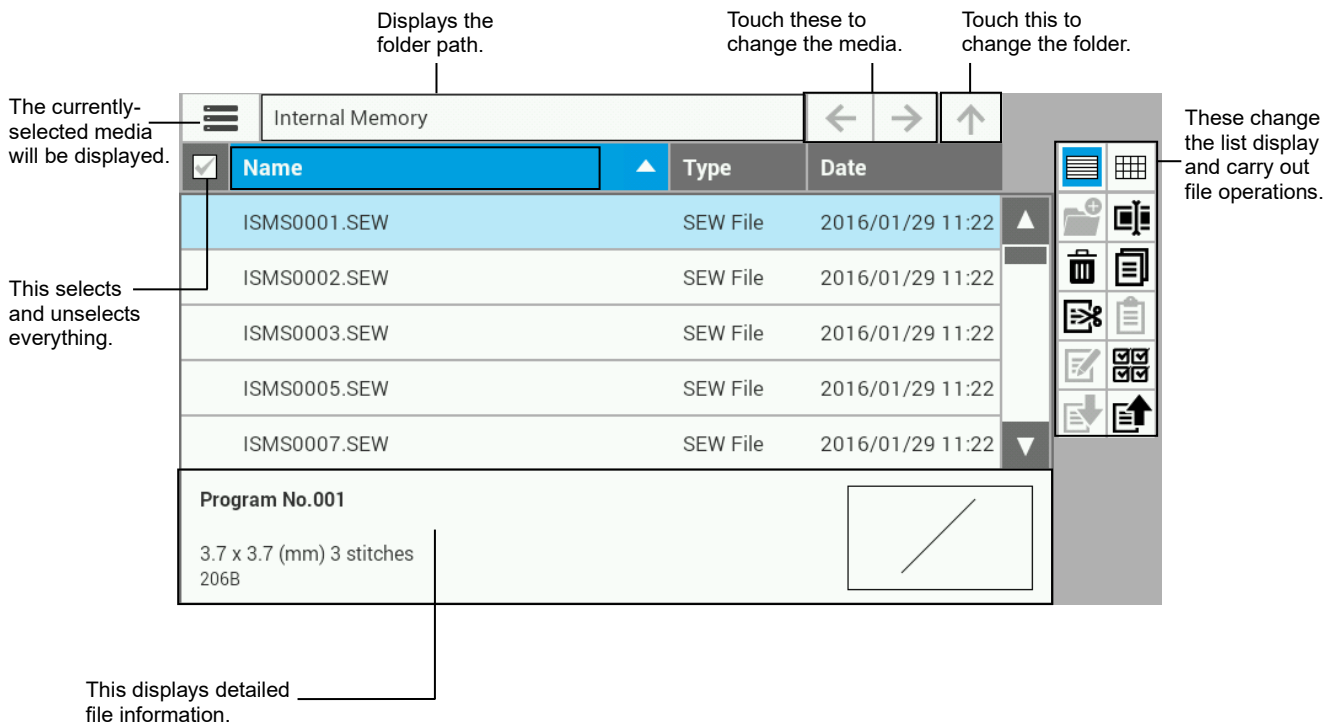

- emb: Sewing data
- sew: Sewing data, cycle programs and user parameters
- seq: Extended option settings
- jpg, png, bmp, gif: Image files

**Description of icons**



<File Manager screen>



**Media selection, file selection, addresses, sorting**











	Selecting media for browsing (Panel internal memory, SD card, USB media)
	Formatting media
	Changing media
	Moving to a higher folder
	Selecting/unselecting all items

**Changing the display**

	Switching to list display
	Switching to icon display

## CHAPTER 5 FILE MANAGER FUNCTIONS

### File and folder operations



	Adding folders
	Editing filenames, folder names and comments
	Deleting files and folders
	Copying files and folders
	Cutting files and folders
	Pasting files and folders
	Editing files
	Switching between multiple select and single select mode
	Writing from the panel internal memory to other media (storage media)
	Reading from other media (storage media) to the panel internal memory



## Displaying file lists

### Checking file information

This displays the details of files and folders which are stored on the various media (panel internal memory and storage media).

1. Connect the media containing the files which you would like to check to the programmer.
2. At the  screen, touch  to display the File Manager.
3. Touch the icon in the top-left corner of the screen to switch to the media which contains the files you would like to check.

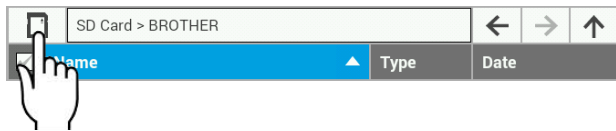



4. Select the file you would like to check. The detailed file information will be displayed at the bottom of the screen.



### Changing the content display method to list format or icon format

This switches the method used for displaying file contents.

1. At the  screen, touch  to display the File Manager.
2. Touch .

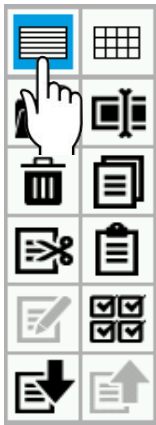

3. The file contents will be displayed in list format.

4. Touch .





5. The file contents will be displayed in icon format.

## Sorting the display (applying sorting conditions)

---

You can sort the file content display according to a specified sort order.

1. At the  screen, touch  to display the File Manager.
2. Touch the "Name", "Type" or "Date" tab at the top of the list.





3. The file contents will be sorted in ascending or descending order based on the item which you touched. (The order switches between ascending and descending each time you touch the same item.)

## File operations

### Deleting files and folders

This deletes files which are stored on the various media (panel internal memory and storage media). It is possible to select more than one file for deleting at the same time.

1. At the  screen, touch  to display the File Manager.

2. Select the file(s) or folder(s) which you would like to delete.

(To delete more than one file or folder, use multiple select mode to select the files or folders which you would like to delete.)

3. Touch .

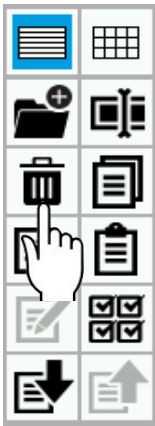

4. The delete confirmation dialog screen is displayed, so touch .

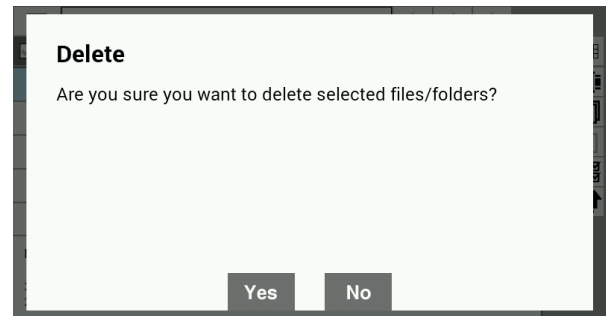

Touch  to return to the file list screen.



5. The selected file(s) or folder(s) will be deleted.

## Copying files and folders

Files and folders which have been saved on media (panel internal memory and storage media) can be copied to the displayed folder. It is possible to select more than one file for copying at the same time.

1. At the  screen, touch  to display the File Manager.

2. Select the file(s) or folder(s) which you would like to copy.

(To copy more than one file or folder, use multiple select mode to select the files or folders which you would like to copy.)

3. Touch .





4. Navigate to the destination folder for copying.

5. Touch .



\* If the files or folders in the copy source and the copy destination are the same, the following dialog screen will be displayed.

To overwrite, touch .

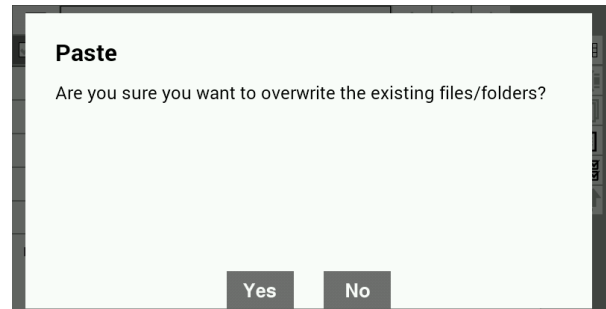

Touch  to return to the file list screen.



6. The selected file(s) or folder(s) will be copied to the displayed folder.

## Moving files and folders

Files and folders which have been saved on media (panel internal memory and storage media) can be moved to the displayed folder. It is possible to select more than one file for moving at the same time.

1. At the  screen, touch  to display the File Manager.

2. Select the file(s) or folder(s) which you would like to move.

(To move more than one file or folder, use multiple select mode to select the files or folders which you would like to move.)

3. Touch .



4. Navigate to the destination folder for moving.

5. Touch .





6. The selected file(s) or folder(s) will be moved to the displayed folder.

## Changing the names of files and folders

This changes the names of files and folders which are stored on the various media (panel internal memory and storage media).

Comments which are attached to files can be changed at the same time.

1. At the  screen, touch  to display the File Manager.
2. Select the file or folders which you would like to change the name of.
3. Touch .



4. The display will change to the filename/folder name editing screen so that you can edit the filename or folder name.

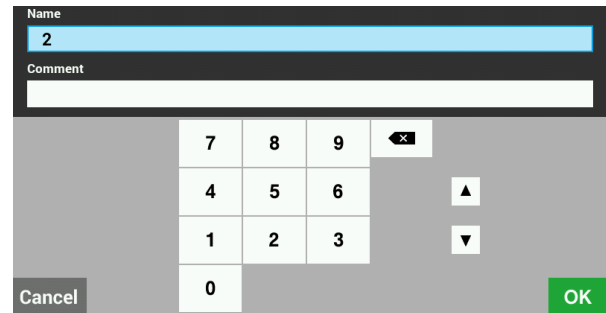

\* In the case of sewing data files, you can edit the comments at the same time.





5. Touch .
6. The filename, folder name and/or comment will be changed to the contents which were edited in step 4.

## Creating folders

You can create new folders in the storage media.

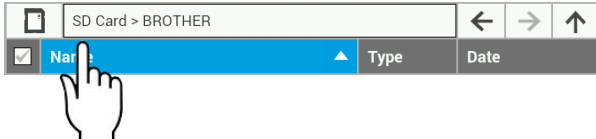
1. At the  screen, touch  to display the File Manager.
2. Touch the icon in the top-left corner of the screen to switch to the storage media.



- \* When creating a folder on an SD card, select  ; when creating a folder on USB media, select .

3. Navigate to the folder where you would like to create a new sub-folder.

4. Touch .



5. The display will change to the folder name entry screen, so that you can enter the name of the folder.

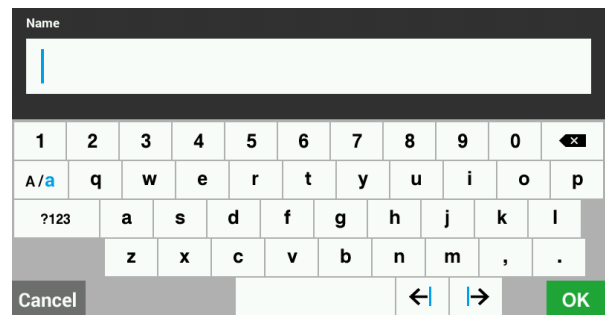



6. Touch .
7. The folder will be created.



**File operations using storage media**

**Importing files from storage media into the panel internal memory**

Files which have been saved on storage media can be imported into the panel internal memory. It is possible to select more than one file for importing at the same time.

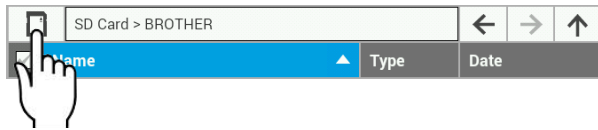
1. Insert the storage media containing the file that you wish to import into the programmer.
2. At the  screen, touch  to display the File Manager.
3. Touch the icon in the top-left of the screen to select the storage media which contains the file that you would like to import.



\* To import a file from an SD card, select  ; to import a file from USB media, select .

4. Touch the file which you would like to import in order to select it.  
(To import more than one file or folder, use multiple select mode to select the files or folders which you would like to import.)



5. Touch .



6. The selected file(s) will be imported into the panel internal memory.

**Exporting files from the panel internal memory to storage media**

Files which have been saved in the panel internal memory can be exported to storage media. It is possible to select more than one file for exporting at the same time.

1. Insert the storage media that you wish to use for exporting the file from the programmer.
2. At the  screen, touch  to display the File Manager.
3. Touch the icon in the top-left corner of the screen to select the panel internal memory.

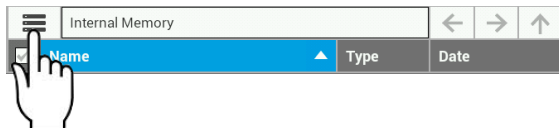

4. Touch the file which you would like to export in order to select it.  
(To export more than one file or folder, use multiple select mode to select the files or folders which you would like to export.)

5. Touch .





6. The selected file(s) will be exported to the storage media.



## Formatting media

You can format media (panel internal memory or storage media) so that it can be used with the programmer.

1. At the  screen, touch  to display the File Manager.
2. Touch the icon in the top-left corner of the screen to select the media which you would like to format.

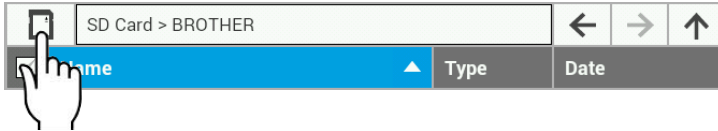

3. Touch the icon in the top-left corner of the screen once more, and then touch  at the bottom of the list.
4. A screen asking you to confirm the formatting operation will be displayed.

Touch **Yes**.

Touch **No** to return to the file list screen.

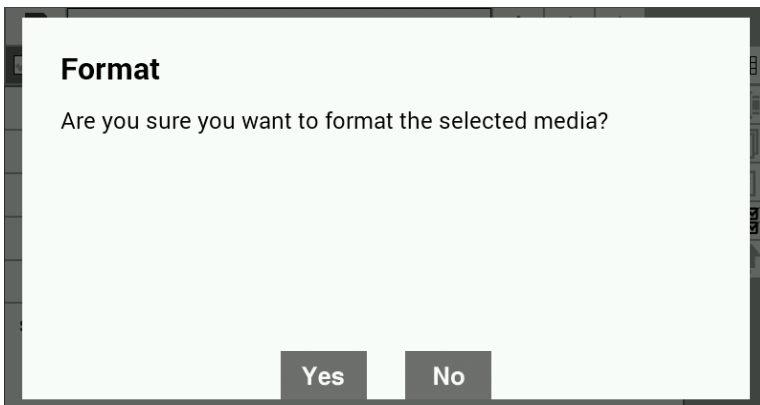

5. The specified media will be formatted, and it can then be used.





## CHAPTER 5 FILE MANAGER FUNCTIONS







# **Chapter 6**

## **Setting Functions**

## Setting the programming functions

You can change the settings which relate to programming functions.  
 The changed settings will be applied when programming.  
 The procedure for changing the programmer settings and the items which can be set are explained below.

1. At the  screen, touch .
2. Touch   to display the programmer settings.
3. Touch the setting value for the setting item which you would like to change, and then change the setting value.  
 \* Refer to the following table for the setting items.
4. Touch OK at the bottom of the screen to apply the changed settings.





Setting item	Summary	Setting value
Jog acceleration pattern	This changes the acceleration pattern for the jog key when it is held down.	1 - 5 Slow ... Fast
Continuous data input	ON: When entering data, it is automatically connected to the end point of the previous outline. OFF: When entering data, an outline start point is entered each time.	ON / OFF
X coordinate initial value (mm)	Changes the initial value for the cursor's X coordinate.	-999 - 999
Y coordinate initial value (mm)	Changes the initial value for the cursor's Y coordinate.	-999 - 999
Option output when checking sewing points	ON: When checking sewing points, the option output signal turns on and off according to the settings for option output codes 1, 2 and 3. OFF: The option output signal is not turned on and off.	ON / OFF
Switching the home key and enter key	ON: The roles of the  key and the  key are switched, only when the Programmer screen is displayed. OFF: The roles of the  key and the  key are not switched.	ON / OFF
Marker display	ON: A marker is displayed at a fixed distance from the cursor  in the Programmer screen. OFF: A marker is not displayed.	ON / OFF
Marker X display position (movement amount from cursor) (mm)	Changes the X coordinate of the marker's display position.	-999 - 999
Marker Y display position (movement amount from cursor) (mm)	Changes the Y coordinate of the marker's display position.	-999 - 999
Starting extended option editing directly	ON: At the Home screen, touch  to display the extended option editing screen. OFF: At the Home screen, touch  to display the programming screen.	ON / OFF
Single SEQ file mode	ON: A single SEQ file is always used for extended option editing. OFF: Settings are saved in multiple SEQ files specified by numbers for extended option editing.	ON / OFF
Preview area enlarged display	When turned on, the program image on the left side of the programming screen appears larger on the screen.	ON / OFF

## Setting the display

You can change settings which relate to the display.

After a setting is changed, it is applied once it is confirmed.





The procedure for changing the display settings and the items which can be set are explained below.

1. At the  screen, touch  .
2. Use   to display the display settings, and then touch the desired setting item.
3. Touch the setting value for the setting item which you would like to change, and then change the setting value.
  - \* Refer to the following table for the setting items.
4. Touch  at the bottom of the screen to apply the changed settings.

Setting item	Summary	Setting value
Brightness	This changes the brightness of the LCD backlight.	1 - 6 Dark ... Bright

## Setting the date and time

You can change settings which relate to the date and time.  
 After a setting is changed, it is applied once it is confirmed.  
 The procedure for changing the date and time settings and the items which can be set are explained below.

1. At the  screen, touch .
2. Use   to display the date and time settings, and then touch the desired setting item.
3. Touch the setting value for the setting item which you would like to change, and then change the setting value.
  - \* Refer to the following table for the setting items.
4. Touch  at the bottom of the screen to apply the changed settings.





Setting item	Summary	Setting value
Time zone	This changes the time zone setting. * Refer to the "List of time zone settings" on the next page for the time zones which can be set.	Refer to the next page.
Year	This changes the year setting.	2015 - 2037
Month	This changes the month setting.	1 - 12
Day	This changes the day setting.	1 - 31
Hour	This changes the hour setting.	1 - 24
Minute	This changes the minute setting.	0 - 59
Date display format	This changes the date display format. Example: When set to YYYY/MM/DD , the date is displayed as "2015/01/01".	YYYY/MM/DD DD/MM/YYYY MM/DD/YYYY
Time display format	This changes the time display format.	12 hours/ 24 hours

## List of time zone settings

Choice	Choice
Midway	Central African Time (Harare)
Honolulu	Baghdad
Anchorage	Moscow
American Pacific Time (Los Angeles)	Kuwait
American Pacific Time (Tijuana)	East Africa Time (Nairobi)
American Mountain Time (Phoenix)	Teheran
Chihuahua	Baku
American Mountain Time (Denver)	Tbilisi
American Central Time (Costa Rica)	Yerevan
American Central Time (Chicago)	Dubai
American Central Time (Mexico City)	Kabul
American Central Time (Regina)	Karachi
Bogota	Oral
American Eastern Time (New York)	Yekaterinburg
Caracas	Calcutta
Atlantic Time (Barbados)	Colombo
Halifax	Kathmandu
Amazon Time (Manaus)	Almaty
Chile/Santiago	Yangon
Newfoundland Standard Time (St. John's)	Krasnoyarsk
Brasilia Time (São Paulo)	Bangkok
Argentina Time	China Standard Time (Beijing)
Nuuk	Hong Kong
Montevideo	Irkutsk
South Georgia Islands	Kuala Lumpur
Azores Islands	Perth
Cabo Verde	Taipei
Casablanca	Seoul
Greenwich Mean Time	Japan Standard Time (Tokyo)
Greenwich Mean Time (London)	Yakutsk
Central European Standard Time (Amsterdam)	Adelaide
Central European Standard Time (Belgrade)	Darwin
Central European Standard Time (Brussels)	Brisbane
Central European Standard Time (Sarajevo)	Hobart
Windhoek	Sydney
West Africa Time (Brazzaville)	Vladivostok
Eastern European Standard Time (Amman)	Guam
Eastern European Standard Time (Athens)	Magadan
Eastern European Standard Time (Beirut)	New Zealand/Auckland
Eastern European Standard Time (Cairo)	Fiji
Eastern European Standard Time (Helsinki)	Majuro
Israel Standard Time (Jerusalem)	Tongatapu
Minsk	





## Setting the language

You can change settings which relate to the language.  
 After a setting is changed, it is applied once it is confirmed.  
 The procedure for changing the language is explained below.

1. At the  screen, touch .
2. Use   to scroll the screen, and select "Language setting" from the list.
3. Touch the language which you would like to select.
  - \* Refer to the settings in the table below for the languages which can be selected.
4. Touch  at the bottom of the screen to apply the changed settings.

## Setting the sound

You can change settings which relate to the sound.  
 After a setting is changed, it is applied once it is confirmed.  
 The procedure for changing the sound settings and the items which can be set are explained below.

1. At the  screen, touch .
2. Use   to scroll the screen, and select "Sound setting" from the list.
3. Touch the setting value for the setting item which you would like to select, and then change the setting value.
  - \* Refer to the following table for the setting items.
4. Touch  at the bottom of the screen to apply the changed settings.





Item No.	Summary	Setting value
Button check sound volume	This changes the volume of the button check sound.	0 - 6 Low ... High
Error check sound volume	This changes the volume of the error check sound. Some fatal errors will generate a sound regardless of this setting.	0 - 6 Low ... High



## Checking information

### Viewing information





You can check information relating to the sewing machine and LCD panel. The steps required in order to check the information are explained below.

1. At the  screen, touch .
2. Use   to scroll the screen, and select "Information" from the list.
3. Touch "Information".

Item No.	Summary
Sewing machine serial number	This displays the serial number of the sewing machine.
Main software version	This displays the version of the main sewing machine software.
Motor software version	This displays the version of the sewing machine motor software.
Panel software version	This displays the version of the LCD panel software.
Maintenance information list	This displays the maintenance information for the sewing machine.
Error log list	This displays the error information for the sewing machine.

## Updating the software





The programmer can be used to update the software for the sewing machine.  
The procedure for updating the sewing machine software is given below.

1. At the  screen, touch .
2. Use   to scroll the screen, and select "Software update" from the list.
3. Touch the item corresponding to the software which you would like to update.
  - \* Refer to the following table for the update items.

Item No.	Summary
Panel software	This lets you update the panel software. * If the update file cannot be found, updating will not be possible.
Main software	This lets you update the main software. * If the update file cannot be found, updating will not be possible.
Motor software	This lets you update the motor software. * If the update file cannot be found, updating will not be possible.

## Checking the software license

The programmer can be used to update the software for the software license.  
The steps required in order to check the software license information are explained below.

1. At the  screen, touch .
2. Use   to scroll the screen, and select "Open source license" from the list.
3. Touch "Open source license".

Item No.	Summary
Open source license	This displays the license for the open source software. * If you touch "Open source license", the license will be displayed.

# brother

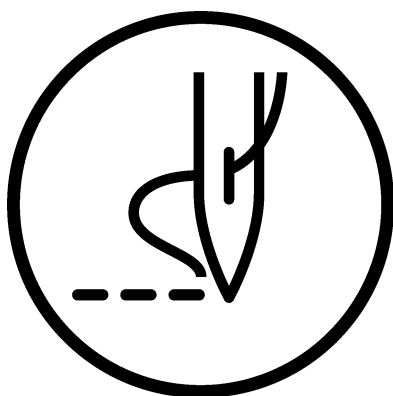

## INSTRUCTION MANUAL

**BROTHER INDUSTRIES, LTD.** <http://www.brother.com/>  
1-5, Kitajizoyama, Noda-cho, Kariya 448-0803, Japan. Phone : 81-566-95-0088

©2021 Brother Industries, Ltd. All Rights Reserved.

This is the original instructions.

BAS J series, Programmer  
I1071604Z E  
2021.07.Z (1)