

UF-8910

UF-8920

INSTRUCTION MANUAL

Please read this manual before using the machine.
Please keep this manual within easy reach for quick reference.

SINGLE NEEDLE DIRECT DRIVE FLAT-BED UNISON-FEED
STITCHER WITH THREAD TRIMMER

TWIN NEEDLE DIRECT DRIVE FLAT-BED UNISON-FEED STITCHER
WITH THREAD TRIMMER

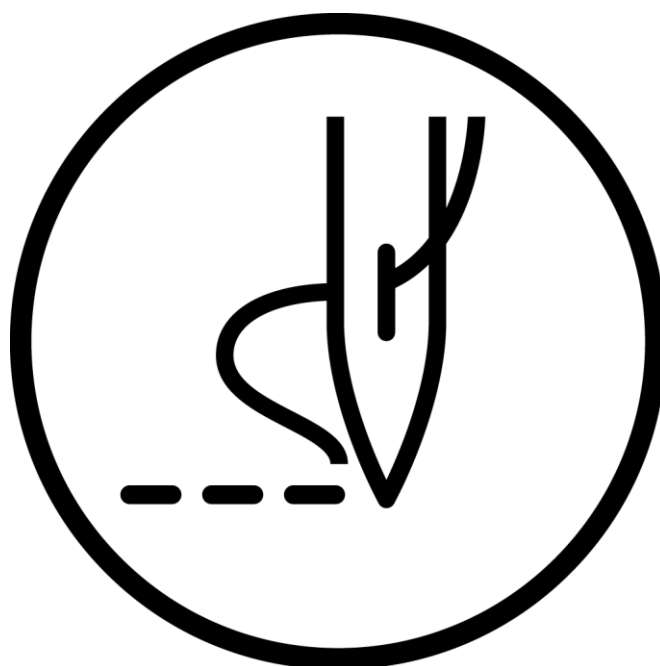

brother

Thank you very much for buying a BROTHER sewing machine. Before using your new machine, please read the safety instructions and the explanations given in the instruction manual.

With industrial sewing machines, it is normal to carry out work while positioned directly in front of moving parts such as the needle and thread take-up, and consequently there is always a danger of injury that can be caused by these parts. Follow the instructions from training personnel and instructors regarding safe and correct operation before operating the machine so that you will know how to use it correctly.



SAFETY INSTRUCTIONS

[1] Safety indications and their meanings

This instruction manual and the indications and symbols that are used on the machine itself are provided in order to ensure safe operation of this machine and to prevent accidents and injury to yourself or other people.

The meanings of these indications and symbols are given below.

Indications

 DANGER	The instructions which follow this term indicate situations where failure to follow the instructions will result in death or serious injury.
 WARNING	The instructions which follow this term indicate situations where failure to follow the instructions could result in death or serious injury.
 CAUTION	The instructions which follow this term indicate situations where failure to follow the instructions may result in minor or moderate injury.

Symbols



.....

This symbol () indicates something that you should be careful of.

The picture inside the triangle indicates the nature of the caution that must be taken.
(For example, the symbol at left means “beware of injury”.)



.....

This symbol () indicates something that you must not do.



.....

This symbol () indicates something that you must do.

The picture inside the circle indicates the nature of the thing that must be done.
(For example, the symbol at left means “you must make the ground connection”.)

[2] Notes on safety



DANGER



Wait at least 5 minutes after turning off the power switch and disconnecting the power cord from the wall outlet before opening the cover of the control box. Touching areas where high voltages are present can result in severe injury.

WARNING



Do not allow any liquids to get onto this sewing machine, otherwise fire, electric shocks or operating problems may occur.



If any liquid gets inside the sewing machine (machine head or control box), immediately turn off the power and disconnect the power plug from the electrical outlet, and then contact the place of purchase or a qualified technician.

CAUTION

Environmental requirements



Use the sewing machine in an area which is free from sources of strong electrical noise such as electrical line noise or static electric noise. Sources of strong electrical noise may cause problems with correct operation.



Any fluctuations in the power supply voltage should be within $\pm 10\%$ of the rated voltage for the machine. Voltage fluctuations which are greater than this may cause problems with correct operation.



The power supply capacity should be greater than the requirements for the sewing machine's power consumption. Insufficient power supply capacity may cause problems with correct operation.



The ambient temperature should be within the range of 5°C to 35°C during use. Temperatures which are lower or higher than this may cause problems with correct operation.



The relative humidity should be within the range of 45% to 85% during use, and no dew formation should occur in any devices. Excessively dry or humid environments and dew formation may cause problems with correct operation.



In the event of an electrical storm, turn off the power and disconnect the power cord from the wall outlet. Lightning may cause problems with correct operation.



Do not connect anything to the USB ports of the panel and the sewing error detection unit other than the USB media. If this is not observed, problems with operation may result.

Installation



Machine installation should only be carried out by a qualified technician.



Contact your Brother dealer or a qualified electrician for any electrical work that may need to be done.



The sewing machine weighs approximately 75 kg (165lb). The installation should be carried out by two or more people.



Do not connect the power cord until installation is complete. The machine may operate if the treadle is depressed by mistake, which could result in injury.



Turn off the power switch before inserting or removing the plug, otherwise damage to the control box could result.



Be sure to connect the ground. If the ground connection is not secure, you run a high risk of receiving a serious electric shock, and problems with correct operation may also occur.



When securing the cords, do not bend the cords excessively or fasten them too hard with staples, otherwise there is the danger that fire or electric shocks could occur.



If using a work table which has casters, the casters should be secured in such a way so that they cannot move.



Secure the table so that it will not move when tilting back the machine head. If the table moves, it may crush your feet or cause other injuries.



Use both hands to hold the machine head when tilting it back or returning it to its original position. If only one hand is used, the weight of the machine head may cause your hand to slip, and your hand may get caught.



Be sure to wear protective goggles and gloves when handling the lubricating oil and grease, so that they do not get into your eyes or onto your skin, otherwise inflammation can result. Furthermore, do not drink the oil or eat the grease under any circumstances, as they can cause vomiting and diarrhea. Keep the oil out of the reach of children.



CAUTION

Lubrication



Turn off the power switch before carrying out work.
The machine may operate if the treadle is depressed by mistake, which could result in injury.



Be sure to wear protective goggles and gloves when handling the lubricating oil, so that it does not get into your eyes or onto your skin.
If care is not taken, inflammation can result. Furthermore, do not drink the lubricating oil. Diarrhea or vomiting may result.
Keep the oil out of the reach of children.



When cutting the nozzle of the oil tank, hold the base of the nozzle securely.
If you hold the end of the nozzle, injury from the scissors may result.

Sewing



This sewing machine should only be used by operators who have received the necessary training in safe use beforehand.



The sewing machine should not be used for any applications other than sewing.



Be sure to wear protective goggles when using the machine.



If goggles are not worn, there is the danger that if a needle breaks, parts of the broken needle may enter your eyes and injury may result.



Turn off the power switch at the following times.
The machine may operate if the treadle is depressed by mistake, which could result in injury.

- When replacing the bobbin and needle
- When not using the machine and when leaving the machine unattended



If using a work table which has casters, the casters should be secured in such a way so that they cannot move.



Attach all safety devices before using the sewing machine.
If the machine is used without these devices attached, injury may result.



Do not touch any of the moving parts or press any objects against the machine while sewing, as this may result in personal injury or damage to the machine.



Secure the table so that it will not move when tilting back the machine head. If the table moves, it may crush your feet or cause other injuries.



Use both hands to hold the machine head when tilting it back or returning it to its original position.
If only one hand is used, the weight of the machine head may cause your hand to slip, and your hand may get caught.



If an error occurs in machine operation, or if abnormal noises or smells are noticed, immediately turn off the power switch. Then contact your nearest Brother dealer or a qualified technician.



If the machine develops a problem, contact your nearest Brother dealer or a qualified technician.



Do not hold the machine head by the panel when tilting it back or returning it to its original position. If this is not observed, it may result in serious injury or damage to the sewing machine.

Cleaning



Turn off the power switch before carrying out cleaning.
The machine may operate if the treadle is depressed by mistake, which could result in injury.



Secure the table so that it will not move when tilting back the machine head. If the table moves, it may crush your feet or cause other injuries.



Use both hands to hold the machine head when tilting it back or returning it to its original position.
If only one hand is used, the weight of the machine head may cause your hand to slip, and your hand may get caught.



Be sure to wear protective goggles and gloves when handling the lubricating oil and grease, so that they do not get into your eyes or onto your skin, otherwise inflammation can result.
Furthermore, do not drink the oil or eat the grease under any circumstances, as they can cause vomiting and diarrhea. Keep the oil out of the reach of children.



Do not hold the machine head by the panel when tilting it back or returning it to its original position. If this is not observed, it may result in serious injury or damage to the sewing machine.

CAUTION

Maintenance and inspection



Maintenance and inspection of the sewing machine should only be carried out by a qualified technician.



Ask your Brother dealer or a qualified electrician to carry out any maintenance and inspection of the electrical system.



Turn off the power switch and disconnect the power cord from the wall outlet at the following times, otherwise the machine may operate if the treadle is depressed by mistake, which could result in injury.

- When carrying out inspection, adjustment and maintenance
- When replacing consumable parts such as the rotary hook and knife



Always be sure to turn off the power switch and then wait one minute before opening the motor cover. If you touch the surface of the motor, it may cause burns.



If the power switch needs to be left on when carrying out some adjustment, be extremely careful to observe all safety precautions.



Secure the table so that it will not move when tilting back the machine head. If the table moves, it may crush your feet or cause other injuries.



Use both hands to hold the machine head when tilting it back or returning it to its original position. If only one hand is used, the weight of the machine head may cause your hand to slip, and your hand may get caught.



When replacing parts and installing optional accessories, be sure to use only genuine Brother parts.

Brother will not be held responsible for any accidents or problems resulting from the use of non-genuine parts.



If any safety devices have been removed, be absolutely sure to re-install them to their original positions and check that they operate correctly before using the machine.



To prevent accidents and problems, do not modify the machine yourself. Brother will not be held responsible for any accidents or problems resulting from modifications made to the machine.



Do not hold the machine head by the panel when tilting it back or returning it to its original position. If this is not observed, it may result in serious injury or damage to the sewing machine.

[3] Warning labels

The following warning labels appear on the sewing machine.

Please follow the instructions on the labels at all times when using the machine. If the labels have been removed or are difficult to read, please contact your nearest Brother dealer.

1		⚠ 危険 高電圧部分にふれて、大けがをすることがある。 電源を切り、5分たってからカバーをはずすこと。	⚠ 危険 触摸高电压部分，会导致受伤。 在切断电源5分钟后，再开启盖罩。
	⚠ DANGER	⚠ GEFAHR	⚠ DANGER
	Hazardous voltage will cause injury. Turn off main switch and wait 5 minutes before opening this cover.	Hochspannung verletzungsgefahr! Bitte schalten sie den hauptschalter aus und warten sie 5 minuten, bevor sie diese abdeckung öffnen.	Un voltage non adapte provoque des blessures. Eteindre l'interrupteur et attendre 5 minutes avant d'ouvrir le capot.
	⚠ PERIGRO		Un voltaje inadecuado puede provocar las heridas. Apagar el interruptor principal y esperar 5 minutos antes de abrir esta cubierta.

2

CAUTION
Moving parts may cause injury.

Operate with safety devices* installed.

Turn off the power before carrying out operations such as threading, changing the needle, bobbin, knives or hook, cleaning and adjusting.

* Safety devices:
Finger guard,
Thread take-up cover,
Side cover, Motor cover, etc.

3 Be careful to avoid injury from the moving thread take-up.

4 Be careful not to get your hands caught when returning the machine head to its original position after it has been tilted.

5 PE Be sure to connect the ground. If the ground connection is not secure, you run a high risk of receiving a serious electric shock, and problems with correct operation may also occur.

6 Direction of operation

7 High temperature warning display

8

brother
Lubricating Oil for Machining
ミシン用潤滑油

⚠ CAUTION

Lubricating oil may cause inflammation to eye and skin. Wear protective glasses and gloves.

Swallowing oil can cause diarrhoea and vomiting. Do not swallow.

Keep away from children.

FIRST AID

Eye contact:
-Rinse with plenty of cold water.
-Seek medical help.

Skin contact:
-Wash with soap and water.

If swallowed:
-Seek medical help immediately.
-Do not induce vomiting.

⚠ 注意

目に入ったり皮膚につくと、炎症を起こすことがある。保護メガネ、手袋を使うこと。

飲み込むと、下痢、嘔吐する。飲み込まないこと。

●子供の手の届かない所に置いてください。

●目に入った場合は、清潔な水で15分間洗浄し、医師の診断を受けてください。

●皮膚に触れた場合は、水と石けんで十分に洗ってください。

●飲み込んだ場合は、無理に吐かせずに、速ちに医師の診断を受けてください。

第4類 第3石油類
危険等級III 火気厳禁

ブラザー工業株式会社
〒448-0803
愛知県刈谷市野田町北地蔵山1番地5
電話：0566-95-0085

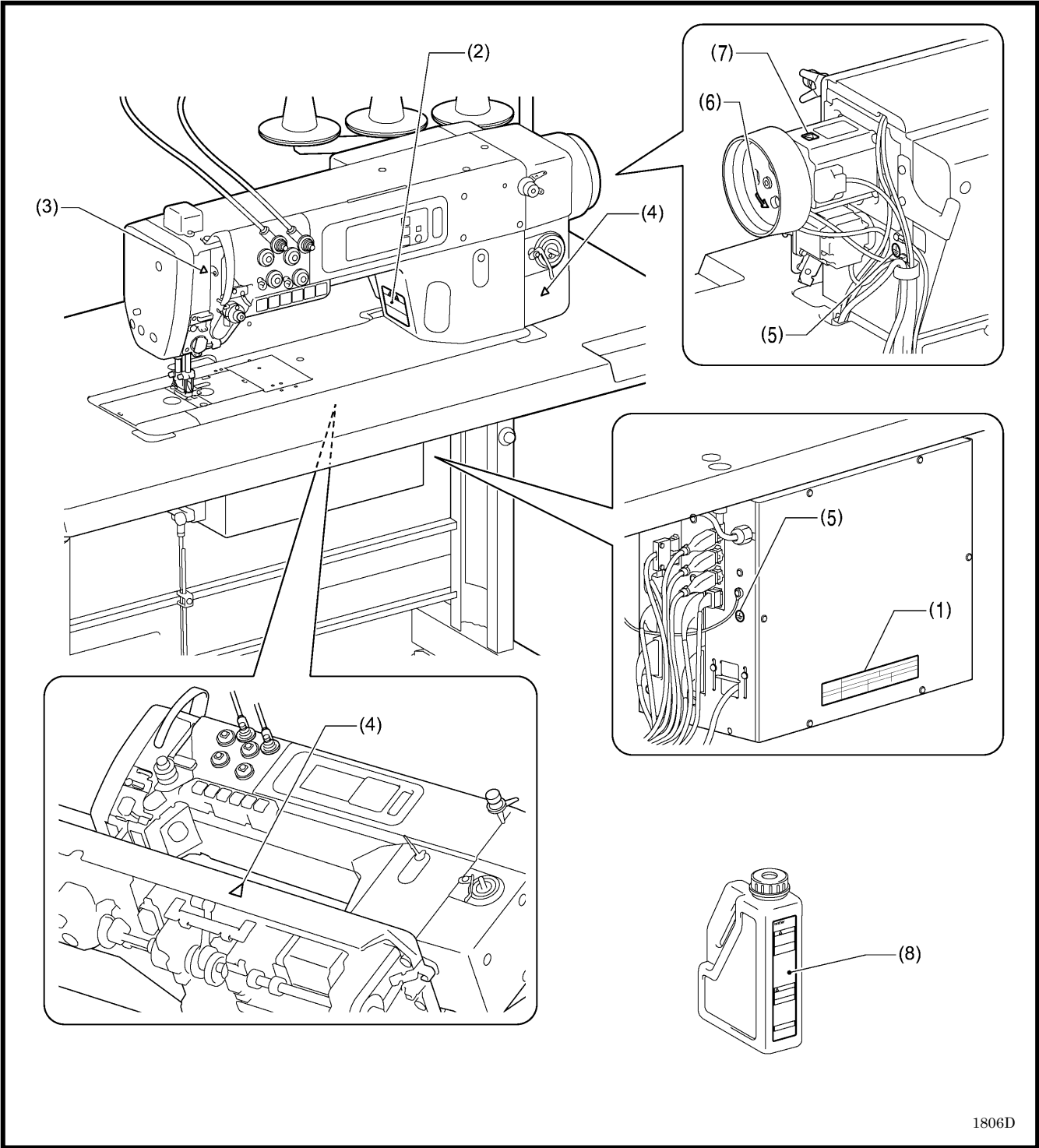

1806D

CONTENTS

1. MACHINE SPECIFICATIONS	1
2. NAMES OF MAJOR PARTS	3
3. INSTALLATION	4
3-1. Table processing diagram	5
3-2. Installing the control box	6
3-3. Installing the connecting rod.....	6
3-4. Installing the oil pan.....	7
3-5. Installing the machine head.....	7
3-6. Installing the cotton stand	9
3-7. Lubrication.....	10
3-8. Connecting the power cord	12
3-9. Connecting the power cord	15
3-10. Test operation (Operating the treadle)	17
3-11. Adjusting the treadle operation	18
4. PREPARATION BEFORE SEWING.....	19
4-1. Installing the needle	19
4-2. Removing the bobbin.....	20
4-3. Winding the lower thread.....	21
4-4. Installing the bobbin	22
4-5. Threading the upper thread	23
5. USING THE SEWING MACHINE (OPERATION PANEL: BASIC OPERATION)	24
5-1. Names and functions.....	24
5-2. Home screen.....	24
5-2-1. Description of detailed home screen	25
5-2-2. Description of simple home screen	26
5-2-3. Types of icons	27
5-3. Menu screen.....	28
5-4. Program setting method	29
5-4-1. Program structure	29
5-4-2. Selecting the sewing start program/seam	30
5-4-3. Seam parameter settings.....	32
5-4-4. Program parameter settings.....	37
5-5. Using the lower thread counter (stitch counter)	42
5-6. Using the production counter.....	44
5-7. Setting the LED brightness	45
6. USING THE SEWING MACHINE (SEWING OPERATION)	46
6-1. Changing the sewing pitch.....	46
6-2. Changing the presser foot pressure	48
6-3. Changing the walking foot stroke	50
6-4. Changing the sewing speed.....	52
6-5. Sewing error detection function (For -101 (sewing error detection) specifications only)	54
6-5-1. Function settings.....	54
6-5-2. When a sewing error is detected.....	55
6-5-3. Resetting the sewing error counter	56
6-6. Material thickness correction function	57
6-6-1. Descriptions of each mode	57
6-6-2. Material thickness correction function settings.....	57
6-7. Sewing start material thickness detection function.....	60
7. USING THE SEWING MACHINE (OPERATION PANEL: ADVANCED OPERATION).....	62
7-1. Adding/deleting/copying seams	62
7-2. Copying programs	67
7-3. Home screen settings.....	69
7-4. Assigning functions to the machine head switches	72
7-5. Memory switch setting method (Standard)	79
7-6. List of memory switch settings	81
7-7. Reading and writing data using USB media.....	82
7-8. Resetting all settings to their defaults.....	83
8. SEWING MACHINE OPERATION.....	84
8-1. Resetting the rotary hook protection device.....	84
8-2. Lifting the work clamp manually	85
8-3. Using the presser foot hold plate.....	85
8-4. Status light bar	86
9. STANDARD ADJUSTMENTS	87
9-1. Adjusting the thread tension.....	87
9-1-1. Upper thread tension adjustment	87
9-1-2. Lower thread tension adjustment.....	89
9-2. Thread take-up amount of thread take-up springs	90
9-3. Thread take-up spring tension.....	91
9-4. Thread take-up amount (adj. the arm thread guide).....	92
9-5. Needle and rotary hook timing.....	92
9-6. Adjusting the thread trimming	94
9-7. Adjusting the rotary hook lubrication amount.....	95
10. CLEANING	96
10-1. Cleaning	96
10-1-1. Cleaning the rotary hook base	96
10-1-2. Cleaning the oil pan.....	96
10-2. Replacing the filter tube assembly	97

10-3. Adding grease (when the grease up warning is displayed).....	98
11. LIST OF ERROR CODES.....	101
12. TROUBLESHOOTING.....	110
12-1. Upper thread breakage or lower thread breakage.....	110
12-2. Skipped stitches at sewing start.....	112
12-3. Skipped stitches occur while sewing.....	113
12-4. Uneven stitches (1) ... Poor thread tightening	114
12-5. Uneven stitches (2) ... Thread clamped.....	114
12-6. Uneven stitches (3) ... Poor upper thread winding (bird's nests at sewing start)	115
12-7. Uneven stitches (4) ... Puckering (excess tightening)	115
12-8. Uneven stitches (5) ... Entire seam.....	116
12-9. Upper thread pulling out	117
12-10. Unstable upper thread trailing length (upper thread pulls out of needle)	117
12-11. Thread is not trimmed	118
12-12. Broken needle	119
12-13. Rotary hook phases do not match	119
12-14. Thread not tightening around X-over seam areas	119
12-15. Feed not moving or is out of step.....	119
12-16. Incorrect sewing pitch.....	120
12-17. Oil in oil tank decreasing too quickly	120
12-18. Lower thread is winding to one side or winding amount is incorrect.....	120
12-19. Sewing machine does not operate at high speed.	121
12-20. Sewing machine stops during sewing	121
12-21. Operation panel display freezes and operation is not possible	121
12-22. Sewing machine does not start when treadle is depressed after power is turned on	121
12-23. Sewing machine does not start when power is turned on.....	122

1. MACHINE SPECIFICATIONS



	0	1
Sewing error detection device	None	Yes

	0	1
Bobbin winder	None	Yes



	UF-8910	UF-8920
Stitch formation	Single needle lock stitch	Twin needle lock stitch (Fixed needle bar type)
Max. sewing speed	3800 sti/min (*1)	3400 sti/min (*1)
Max. speed for backtack sewing	2000 sti/min (*2)	
Max. stitch length	12mm (*3)	
Max. presser foot height	20mm	
Max. walking foot stroke	9mm	
Presser foot pressure	75 - 120N	
Upper thread tension	0.7 - 7.0N	
Arm pocket size	400mm	
Hook size	28 mm rotary hook	
Minimum stitch width	3mm	
Maximum stitch width	35mm	
Needle	134×35 Nm130 (#21) Nm90 - 180 (#14 - #24)	134×35 Nm160 (#23) Nm90 - 180 (#14 - #24)
Illumination LED	Standard equipment	
No. of programs	15 (Up to 20 seams per program)	
Motor	AC servo motor	
Weights	Machine head approx. 75 kg	
	Control box approx. 10 kg	
Power supply	200V - 240V	

- *1 Reduce the maximum sewing speed in accordance with the sewing conditions.
The maximum sewing speed is limited by the pitch and the walking foot stroke. Refer to the table on the following page for specific details on the limits.
- *2 Reduce the maximum sewing speed of backtack sewing in accordance with the sewing conditions.
The maximum sewing speed is limited by the pitch and the walking foot stroke. Refer to the table on the following page for specific details on the limits.
- *3 For pitches larger than 9 mm, use a commercially-available gauge parts.

<Maximum sewing speed>

Single needle (Sewing speed)		Sewing pitch		
		0 - 6.0	6.1 - 9.0	9.1 - 12.0
Walking foot stroke	0.5 - 3.0	3800	3000	2000
	3.5 - 4.0	3100	3000	2000
	4.5 - 6.0	2500	2500	2000
	6.5 - 9.0	1800	1800	1800

Twin needle (Sewing speed)		Sewing pitch		
		0 - 6.0	6.1 - 9.0	9.1 - 12.0
Walking foot stroke	0.5 - 3.0	3400	3000	2000
	3.5 - 4.0	3000	3000	2000
	4.5 - 6.0	2500	2500	2000
	6.5 - 9.0	1800	1800	1800

<Maximum sewing speed for backtack sewing>

Single needle (Sewing speed)		Sewing pitch			
		0 - -3.9	-4.0 - -5.9	-6.0 - -8.9	-9.0 - -12.0
Walking foot stroke	0.5 - 3.0	3800	3000	2500	2000
	3.5 - 4.0	3100	3000	2500	2000
	4.5 - 6.0	2500	2500	2500	2000
	6.5 - 9.0	1800	1800	1800	1800

Twin needle (Sewing speed)		Sewing pitch			
		0 - -3.9	-4.0 - -5.9	-6.0 - -8.9	-9.0 - -12.0
Walking foot stroke	0.5 - 3.0	3400	3000	2500	2000
	3.5 - 4.0	3000	3000	2500	2000
	4.5 - 6.0	2500	2500	2500	2000
	6.5 - 9.0	1800	1800	1800	1800

2. NAMES OF MAJOR PARTS

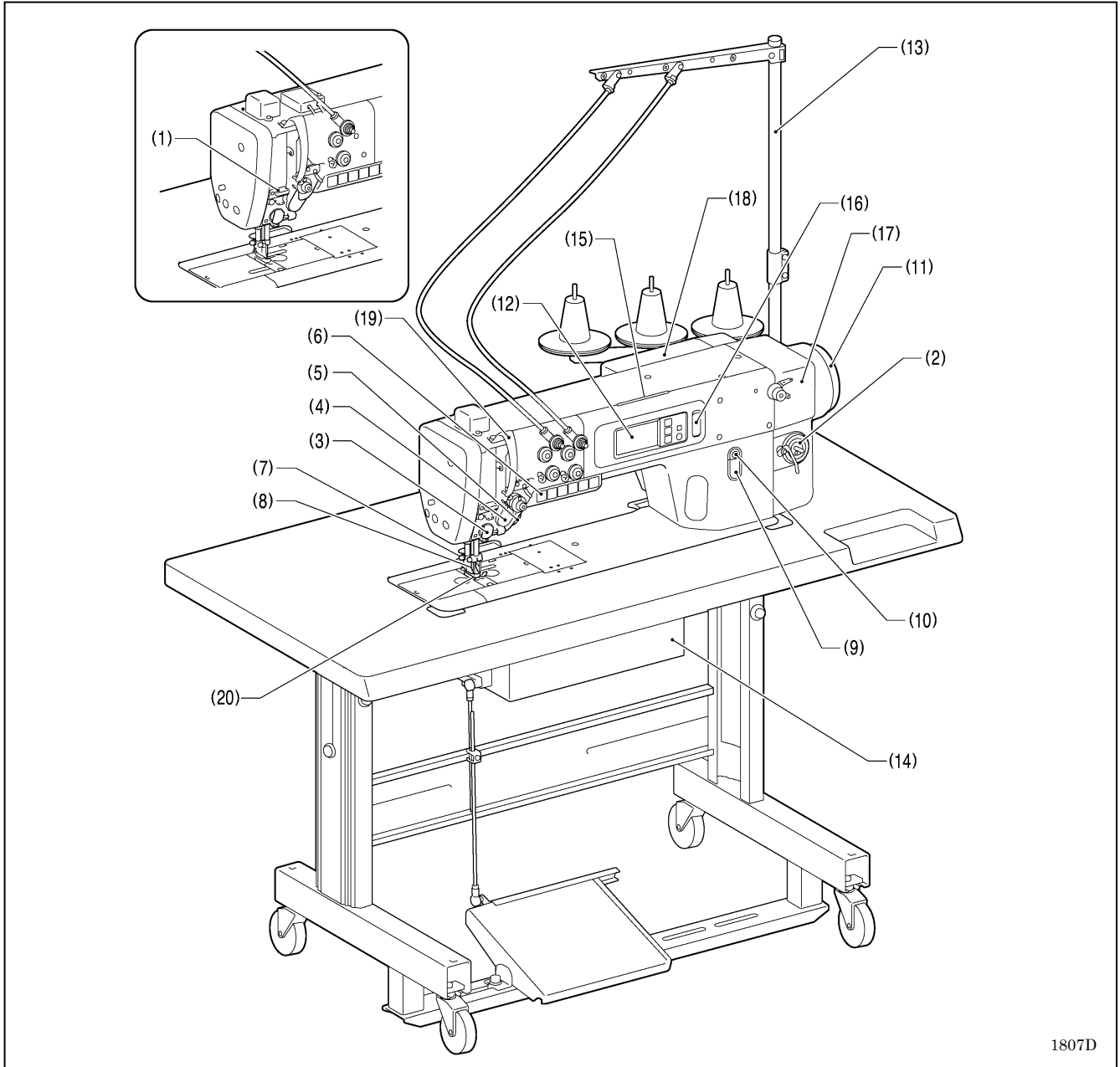

1807D







- | | |
|-----------------------------------|--|
| (1) Sewing error detection device | (2) Bobbin winder |
| (3) Thread presser | (4) Hand switch |
| (5) Jog dial | (6) 6 function buttons |
| (7) Presser foot | (8) Walking foot |
| (9) Oil gauge window | (10) Oil feeding pocket |
| (11) Machine pulley | (12) Operation panel |
| (13) Cotton stand | (14) Control box |
| (15) Status light bar | (16) USB port (for sending and receiving data) |

Safety devices:

- | | |
|---------------------------|-------------------|
| (17) Motor cover | (18) Side cover |
| (19) Thread take-up cover | (20) Finger guard |

3. INSTALLATION

CAUTION

-  Machine installation should only be carried out by a qualified technician.
-  Secure the table so that it will not move when tilting back the machine head. If the table moves, it may crush your feet or cause other injuries.
-  Contact your Brother dealer or a qualified electrician for any electrical work that may need to be done.
-  Use both hands to hold the machine head when tilting it back or returning it to its original position. If only one hand is used, the weight of the machine head may cause your hand to slip, and your hand may get caught.
-  The sewing machine weighs approximately 75kg. Installation of the sewing machine should be carried out by two or more people.
-  Do not connect the power cord until installation is complete. The machine may operate if the treadle is depressed by mistake, which could result in injury.

About the machine set-up location

- Do not set up this sewing machine near other equipment such as televisions, radios or cordless telephones, otherwise such equipment may be affected by electronic interference from the sewing machine.
- The sewing machine should be plugged directly into an AC wall outlet. Operation problems may result if extension cords are used.

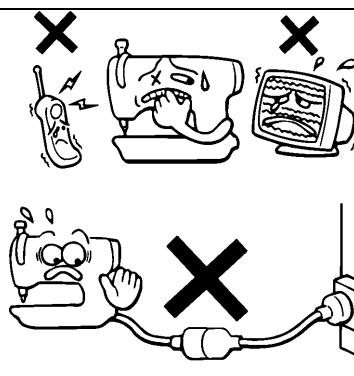

0475D

Carrying the machine

- Remove the rubber caps and screw the lifting hooks to the two screws holes (M10). Be sure to use the crane when lifting the machine, as shown in the illustration.

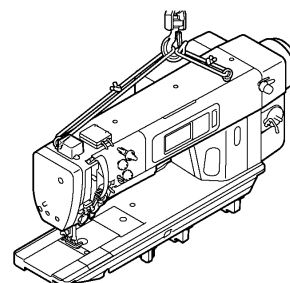

1807D

Tilting back the machine head

1. Pack away any tools which are near the table.
2. Secure the foot (A) so that the table will not move, and then pull the arm with both hands to tilt back the machine head.

* Do not hold the operation panel.

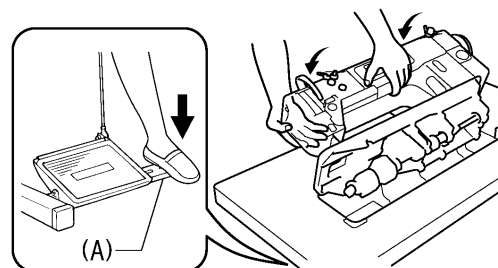

1804D

Returning the machine head to the upright position

1. Pack away any tools which are near the table.
2. While supporting the arm with both hands, gently return the machine head to its original position.

* Do not hold the operation panel.

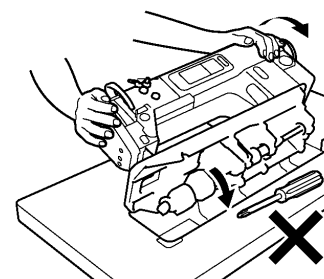

1805D

3. INSTALLATION

3-1. Table processing diagram

- The thickness of the table should be at least 40 mm, and it should be strong enough to bear the weight and vibration of the sewing machine.
- Drill holes as indicated in the diagram below
- The forward/back and sideways position of the sewing machine on the work table is shown for reference. Note that if the distance from the control box is too great, the harness may not reach sufficiently.

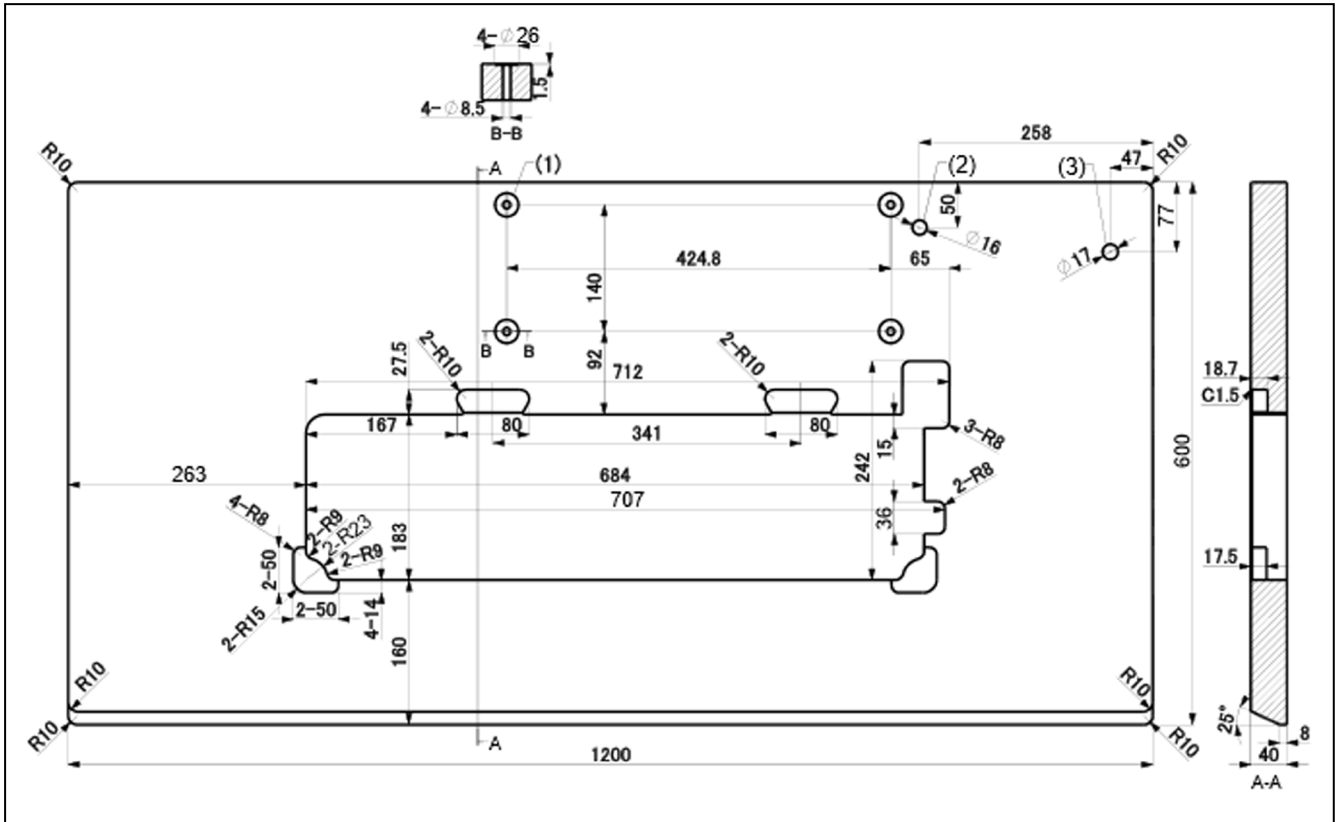

- (1) Control box mounting hole
- (2) Head rest installation hole
- (3) Spool stand installation hole

3-2. Installing the control box



CAUTION



Before installing the control box, take steps to make sure that the control box does not fall down. If this is not done, injury to feet or damage to the control box may result.

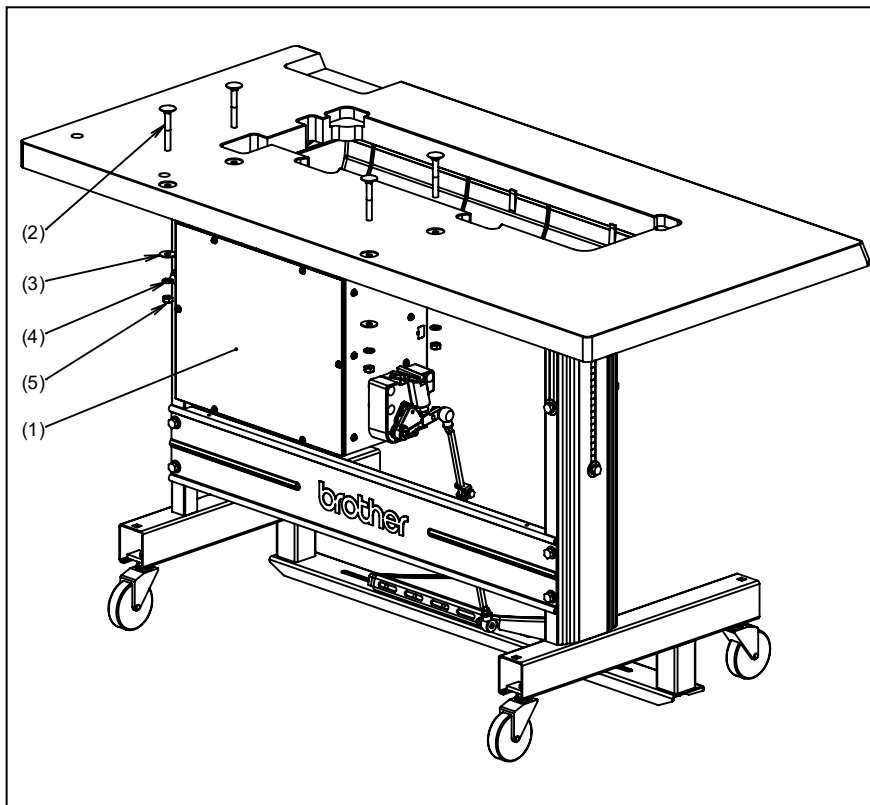

- (1) Control box
- (2) Bolts [4 pcs.]
- (3) Washers [4 pcs.]
- (4) Spring washers [4 pcs.]
- (5) Nuts [4 pcs.]

3-3. Installing the connecting rod

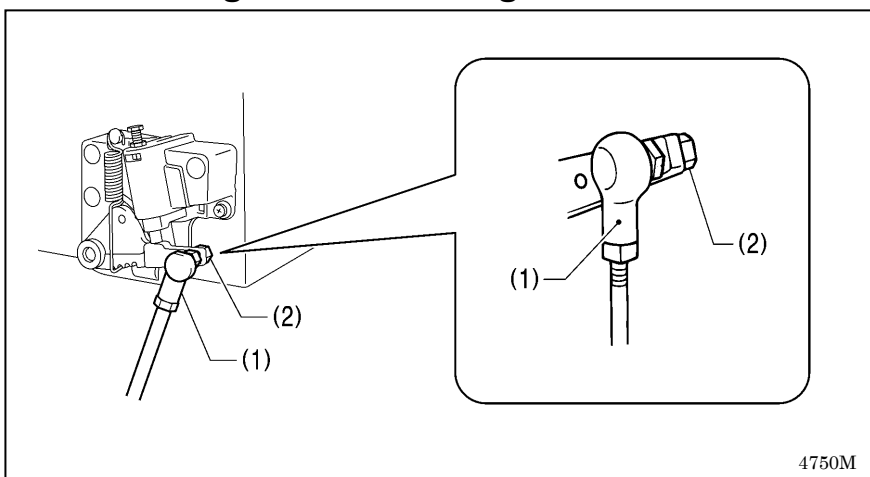

- (1) Connecting rod
- (2) Nut

4750M

3. INSTALLATION

3-4. Installing the oil pan

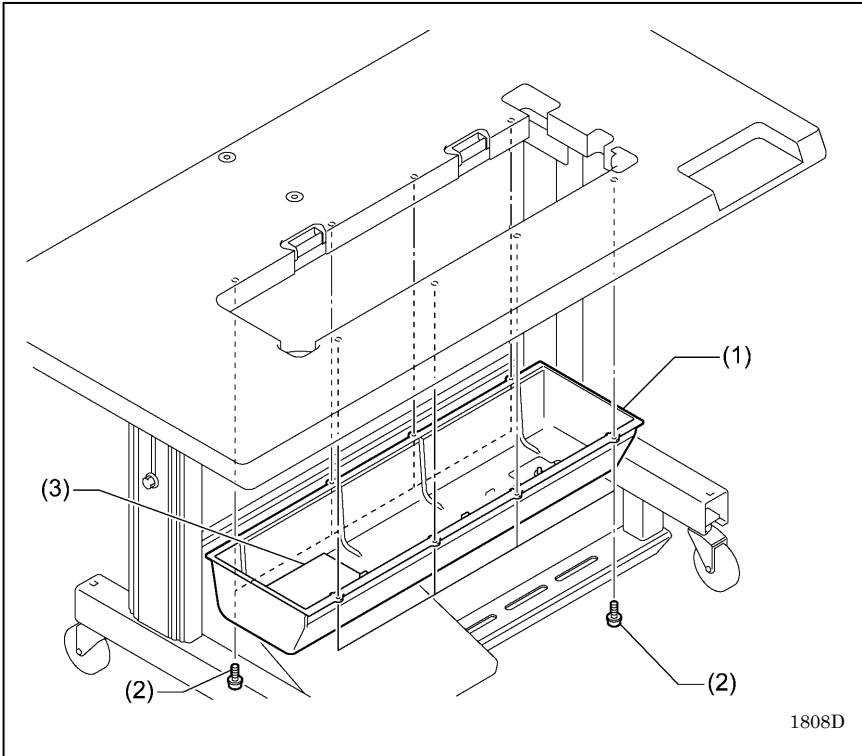

- (1) Oil pan
- (2) Screws [8 pcs.]
- (3) Sponge

* Set the forward/back and sideways position of the oil pan so that the projections at the top are touching front and left sides.

3-5. Installing the machine head

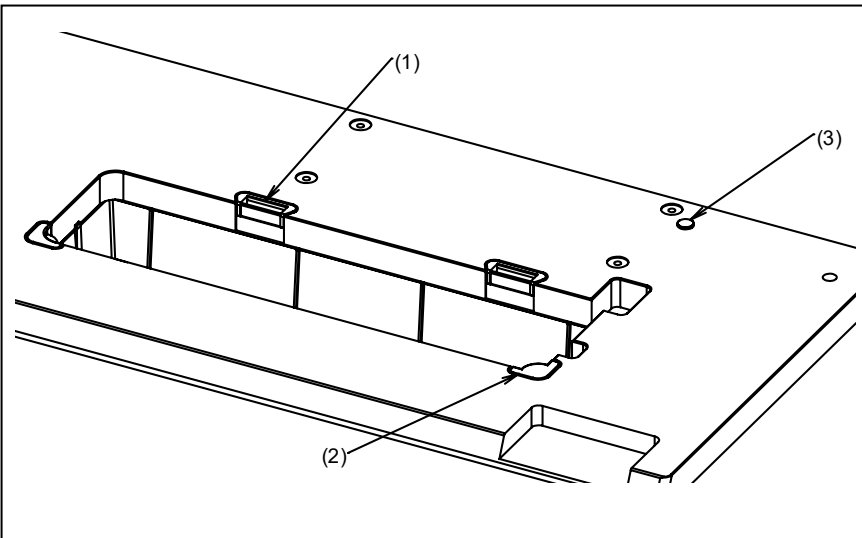

- (1) Hinge cushions [2 pcs.]
- (2) Machine head cushions [2 pcs.]
- (3) Machine head holder

[NOTE]

- Tap the machine head holder (3) into the table hole as far as it will go.
- If the machine head holder (3) is not tapped in as far as it will go, there is the danger that the machine head will not be sufficiently stable when it is tilted back.

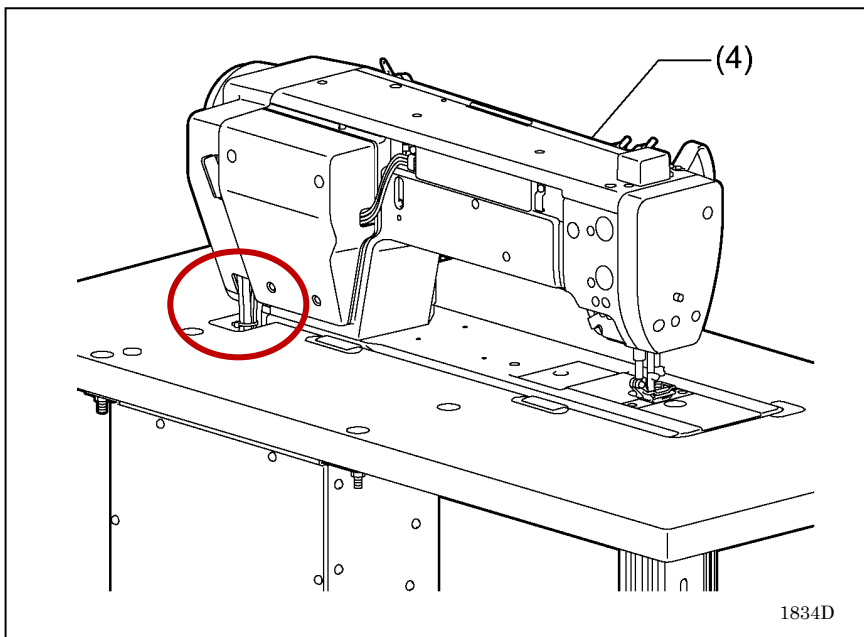

(4) Machine head

[NOTE]
 Bind the cords together and pass them through the cord hole.

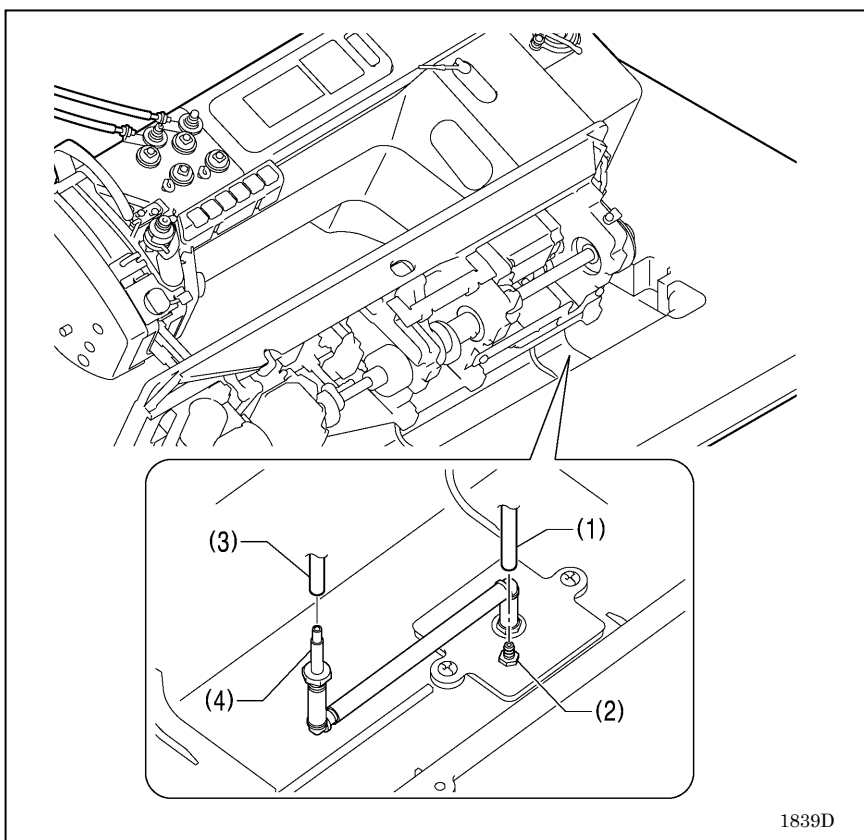

Connect the long tube (1) which is coming out from the machine head to the oil pipe (2) of the oil pan cover, and connect the short tube (3) to the oil pipe (4) of the tube which extends from the oil pan.

3-6. Installing the cotton stand

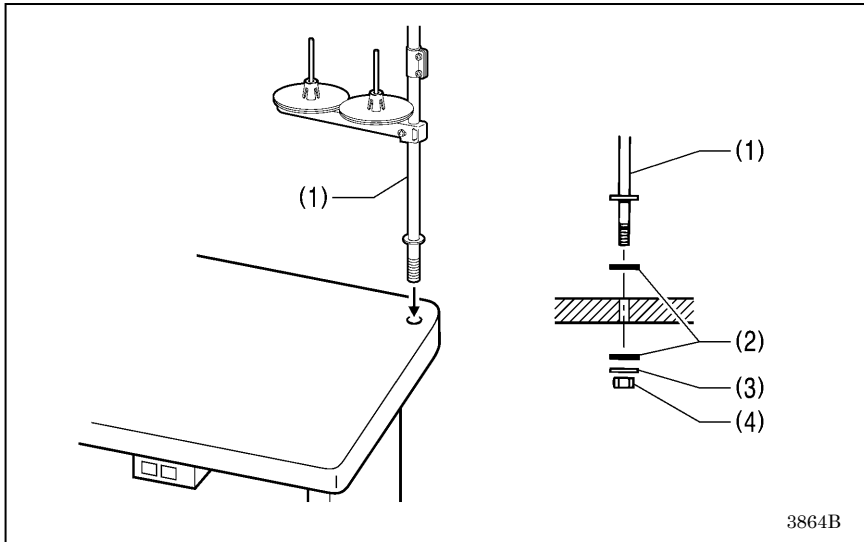



- (1) Cotton stand
- (2) Washers
- (3) Spring washer
- (4) Nut

[NOTE]

Securely tighten the nut (4) to secure the cotton stand (1) so that it does not move and so that the two washers (2) and the spring washer (3) are securely clamped.

3-7. Lubrication

CAUTION

-  Do not connect the power cord plug until adding lubricating oil is complete. The machine may operate if the treadle is depressed by mistake, which could result in injury.
-  Be sure to wear protective goggles and gloves when handling the grease so that it does not get into your eyes or onto your skin. Otherwise inflammation can result. Furthermore, do not drink the oil or eat the grease under any circumstances. Diarrhea or vomiting may result. Keep the oil out of the reach of children.

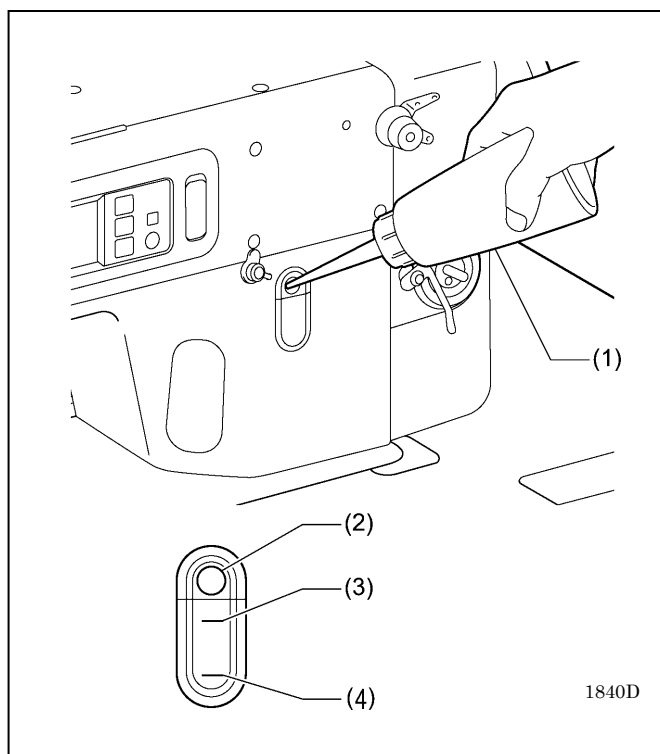

The sewing machine should always be lubricated and the oil supply replenished before it is used for the first time, and also after long periods of non-use.

Use only the lubricating oil <ENEOS Sewinglube 10N; VG10> specified by Brother.

1. Open the oil feeding pocket cover.
2. Insert the nozzle of the oiler (1) deeply into the oil feeding pocket (2), and then add lubricating oil.
3. Check that the lubricating oil comes to the upper reference line (3) in the oil gauge window.
4. Close the oil feeding pocket cover.

3. INSTALLATION

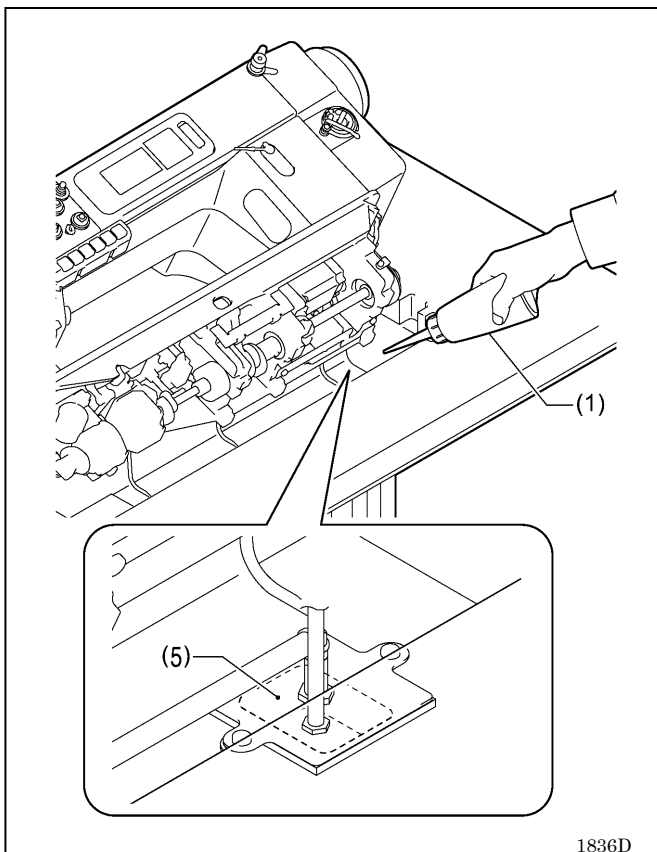

5. Tilt back the machine head.
6. Transfer the sewing machine oil to the oiler (1) and lubricate the pulley of the oil pan. The amount of oil to add is 360 ml (about twice the capacity of the oiler).

<Lubricating oil replenishment interval>

If the lubricating oil level drops below the lower reference line (4) of the oil gauge window, be sure to add more oil.

NOTE:

When the sewing machine is operated for the first time, the lubricating oil decreases rapidly, but this is normal and not the sign of a problem. Consumption of lubricating oil is quick until the oil collects in the oil pan, but after the lubricating oil collects in the oil pan the consumption stabilizes. When lubricating oil has collected in the sump (5) of the oil pan, oil consumption will stabilize.

1836D

3-8. Connecting the power cord

⚠ CAUTION

- ⚠ **Contact your Brother dealer or a qualified electrician for any electrical work that may need to be done.**
- ⊘ **Do not connect the power cord until all other cords have been connected.**
The machine may operate if the treadle is depressed by mistake, which could result in injury.
- ⚠ **When securing the cords, do not bend the cords excessively or fasten them too hard with staples.**
If this is not observed, there is the danger that fire or electric shocks could occur.
- ⊘
- ⚡ **Be sure to connect the ground.**
If the ground connection is not secure, you run a high risk of receiving a serious electric shock, and problems with correct operation may also occur.

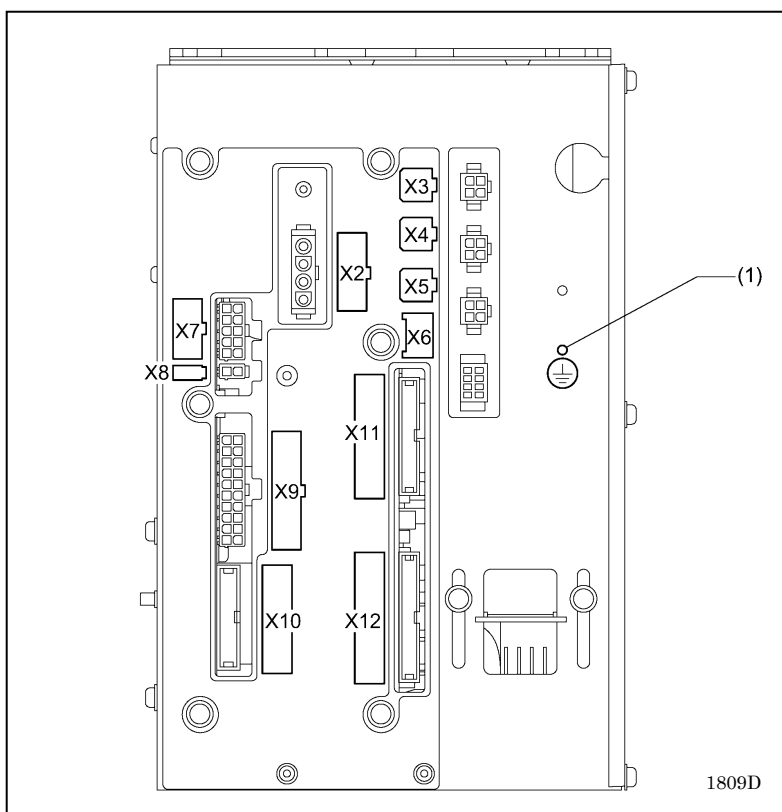

Connect the cords.

Connect the ground wire (1).

[NOTE]

Bind the cords in such a way that the connector does not get pulled out.
If the cords become severed due to vibration from the sewing machine, damage to the control box could result.

Connectors	Control box indications
Main shaft motor connector 4-pin	X2
Presser foot motor connector 4-pin	X3
Walking foot motor connector 4-pin	X4
Feed motor connector 4-pin	X5
Operating panel connector 10-pin	X6
Relay Solenoid connector 10-pin	X7
Edge guide power supply 2-pin	X8
Relay OP connector 20-pin	X9
Relay motor connector 26-pin	X10
Relay encoder connector 30-pin	X11
Relay machine head connector 34-pin	X12

3. INSTALLATION

<For -101 (sewing error detection) specifications>

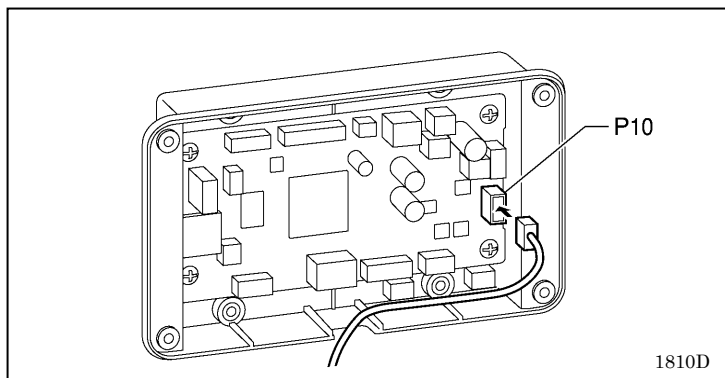

Connect the connector of the sewing error detection amplifier harness which leads from the machine head to P10 on the sewing error detection control P.C. board.

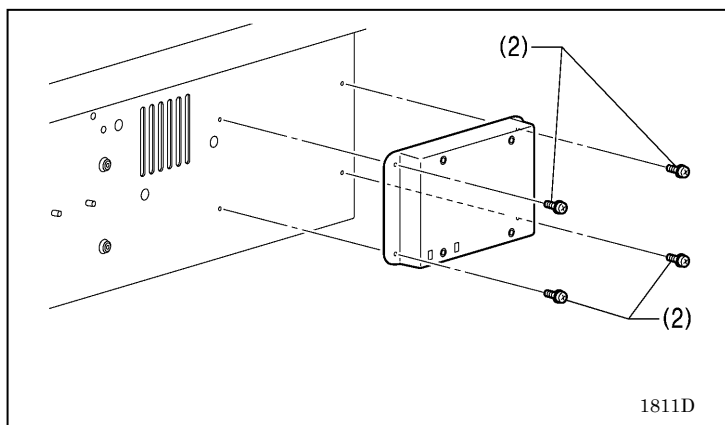

Loosen the four screws (2), and then install the sewing error detection control unit to the control box.

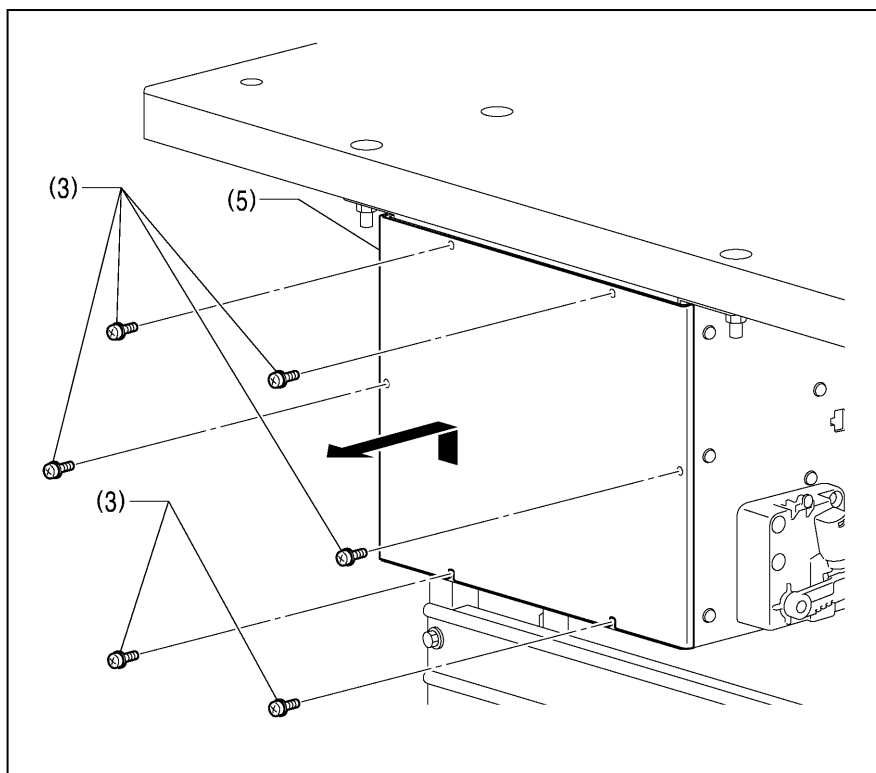

- (3) Screws
- (4) Control box

Remove the six screws (3), and then remove the control box cover (5).

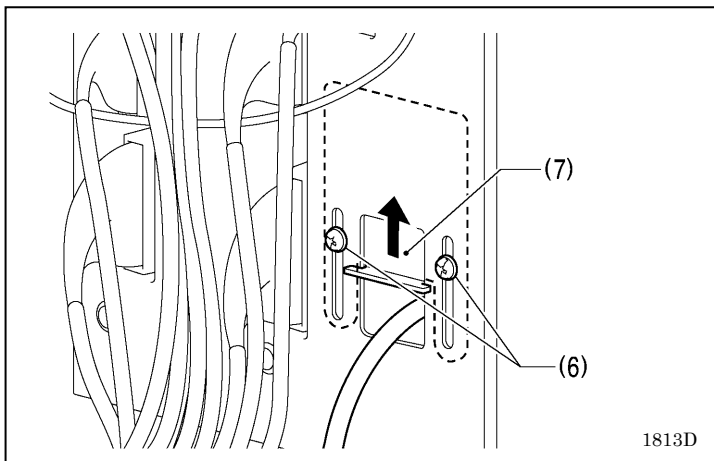

Loosen the two screws (6), and then open the cord presser plate (2) in the direction of the arrow and pass the error detection control harness through the opening.

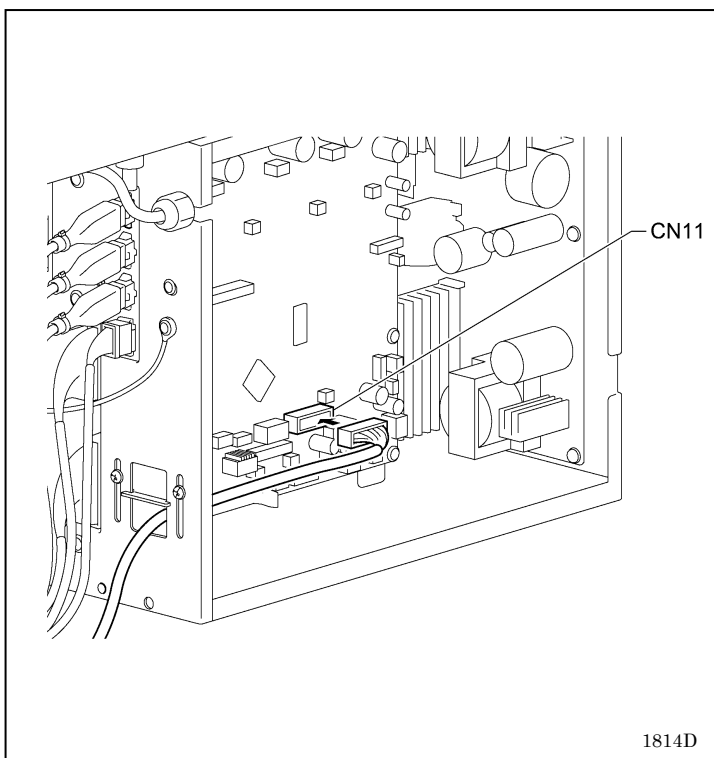

Connect the connector of the error detection control harness which leads from the machine head to CN11 on the main P.C. board.

Loosen the cables outside the control box without stretching them too much inside the control box.

[NOTE]

- Check that the connectors are facing the correct way, and then insert them firmly until they lock into place.
- Make sure that the connector does not get pulled out.

Close the cord presser plate (7) and tighten the two screws (6).

[NOTE]

Close the cord presser plate (7) securely so that no foreign objects, insects or small animals can get inside the control box.

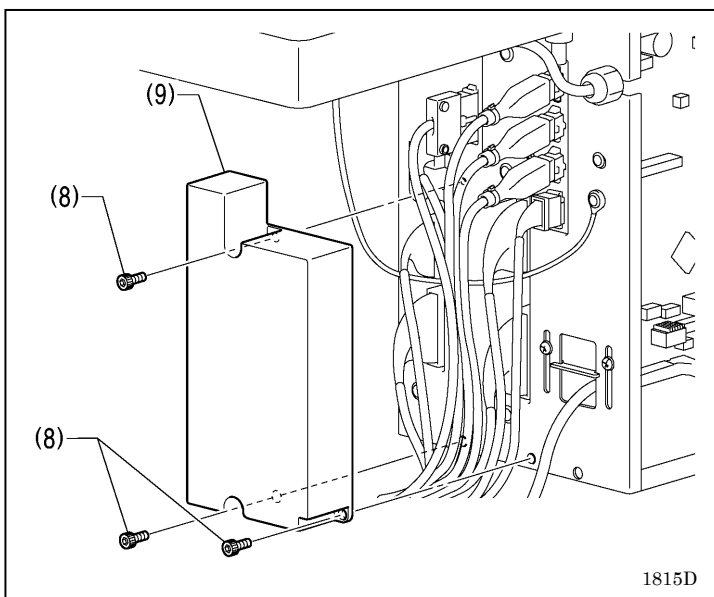

Pull out the harness downward from the opening in the connector cover (9).

Loosen the three accessory socket bolts (8), and then install the harness cover to the side of the control box.

3-9. Connecting the power cord



Be sure to connect the ground.

If the ground connection is not secure, you run a high risk of receiving a serious electric shock, and problems with correct operation may also occur.

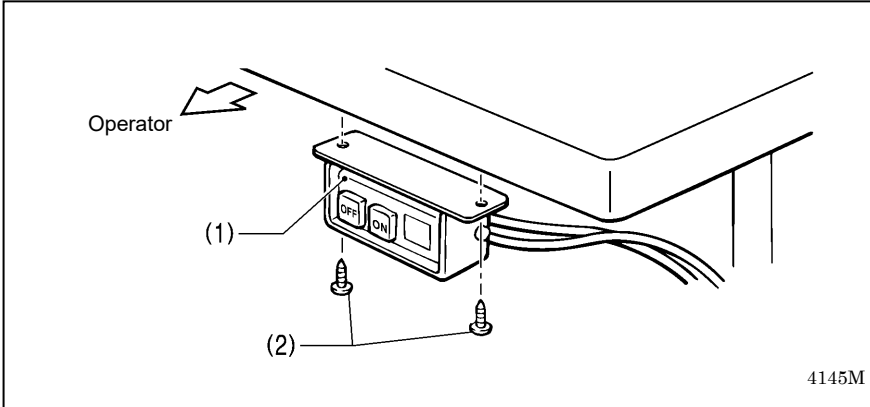

Connect a cord that matches the voltage specifications.

- (1) Power switch
- (2) Wood screws [2 pcs.]

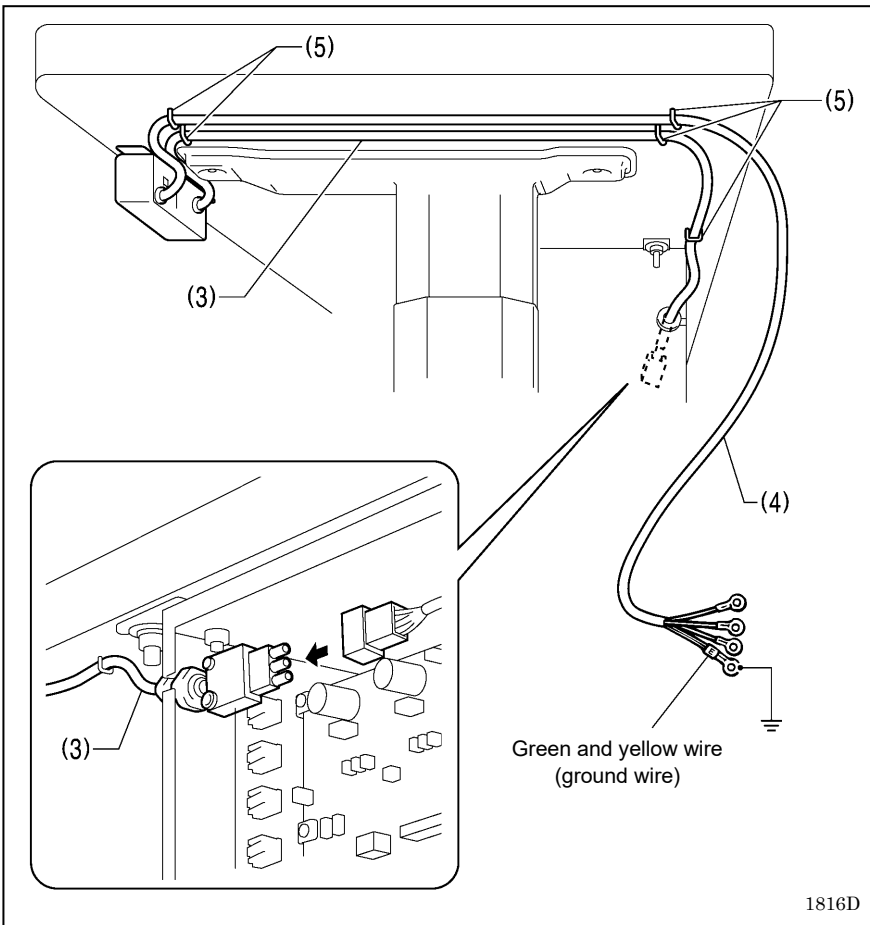

- (3) Power supply connector 3-pin
- (5) Staples [5 pcs.]

1. Attach an appropriate plug to the power cord (4).
(The green and yellow wire is the ground wire.)
2. Insert the power plug into a properly-grounded electrical outlet.

[NOTE]

- Take care when tapping in the staples (5) to make sure that they do not pierce the cords.
 - Do not use extension cords. They may cause problems with correct operation of the sewing machine.
3. Tighten the control box cover with the six screws.
Check that the cords are not clamped by the cover at this time.

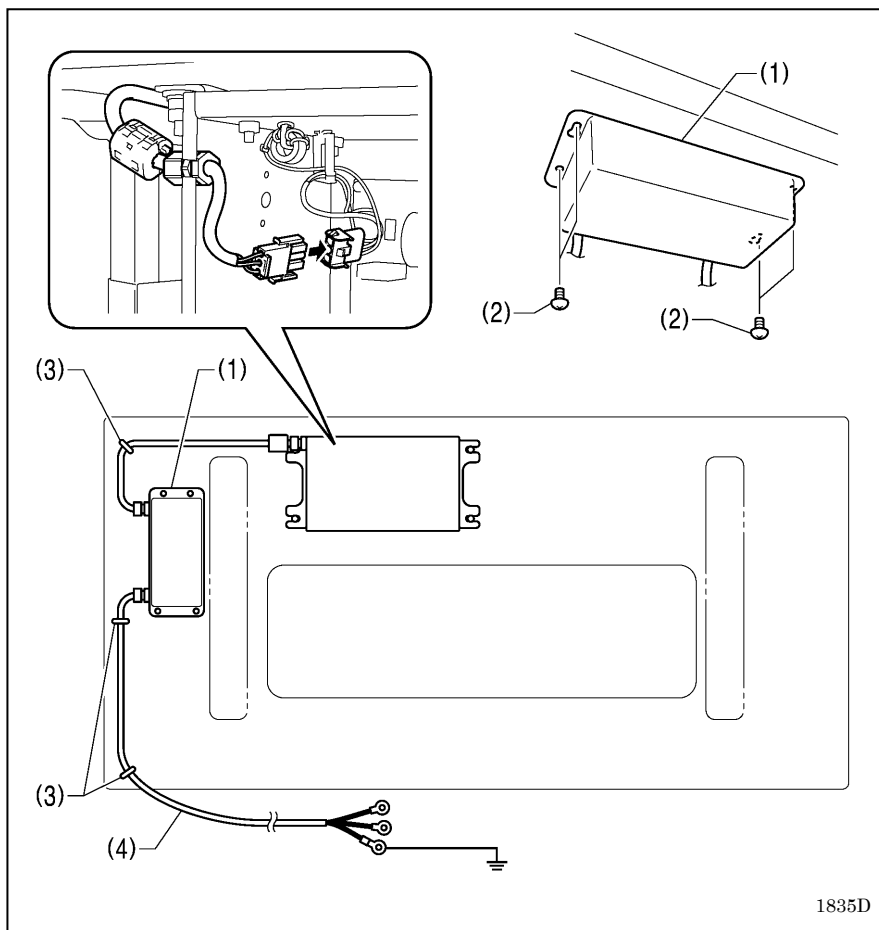

Connect cords that match the voltage specifications

<EU specifications>

- (1) Filter box
- (2) Screws [4 pcs]
- (3) Staples [3 pcs]
- (4) Power cord

1. Attach an appropriate switch and cable to the power cord (4).
(The green and yellow wire is the ground wire.)
2. Insert the power plug into a properly-grounded electrical outlet.

[NOTE]

- Take care when tapping in the five staples (3) to make sure that they do not pierce the cords.
- Do not use extension cords, otherwise machine operation problems may result.

1835D

3-10. Test operation (Operating the treadle)

! CAUTION



Do not touch any of the moving parts or press any objects against the sewing machine while it is operating. If this is not observed, it may result in serious injury or damage to the sewing machine.

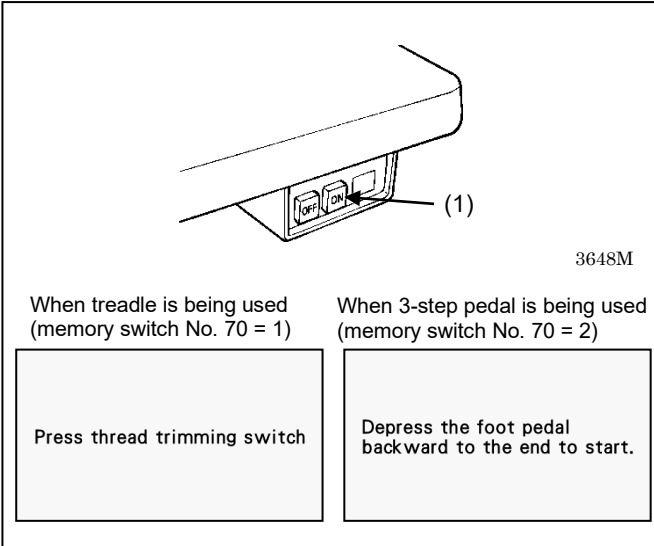

<Turning on the power>

Turn on the POWER switch (1).

Once the power has turned on, depress the pedal.

* If using the 3-step pedal, depress the thread trimming pedal.

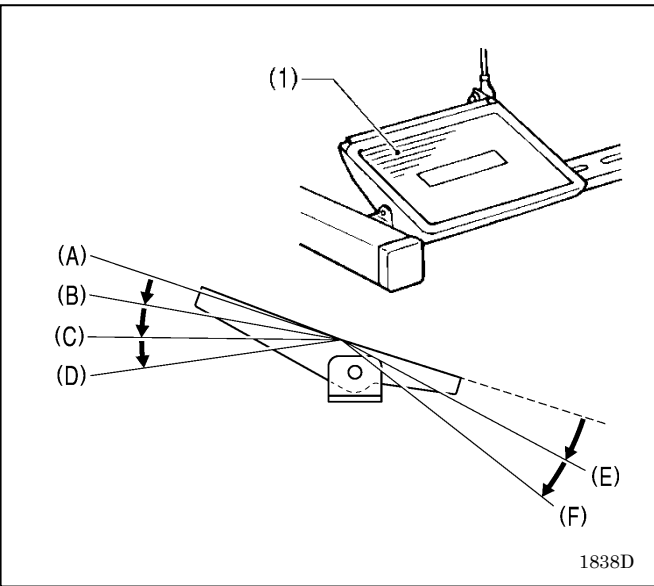

<Test operation>

1. Gently depress the treadle (1) to position (B) to lower the presser foot.
2. Check that sewing is carried out at low speed when the treadle (1) is then pressed to position (C).
3. Check that sewing is carried out at high speed when the treadle (1) is then pressed to position (D).
4. After depressing the treadle (1) forward, check that the needle is lowered to the top of the needle plate and stops when the treadle (1) is returned to the neutral position (A) [released]. (When needle down stopping has been set.)
5. When the treadle (1) is depressed backward to (E), the presser foot rises.
6. If the treadle (1) is then depressed to position (F), thread trimming is carried out and the needle then rises above the needle plate and stops.

3-11. Adjusting the treadle operation

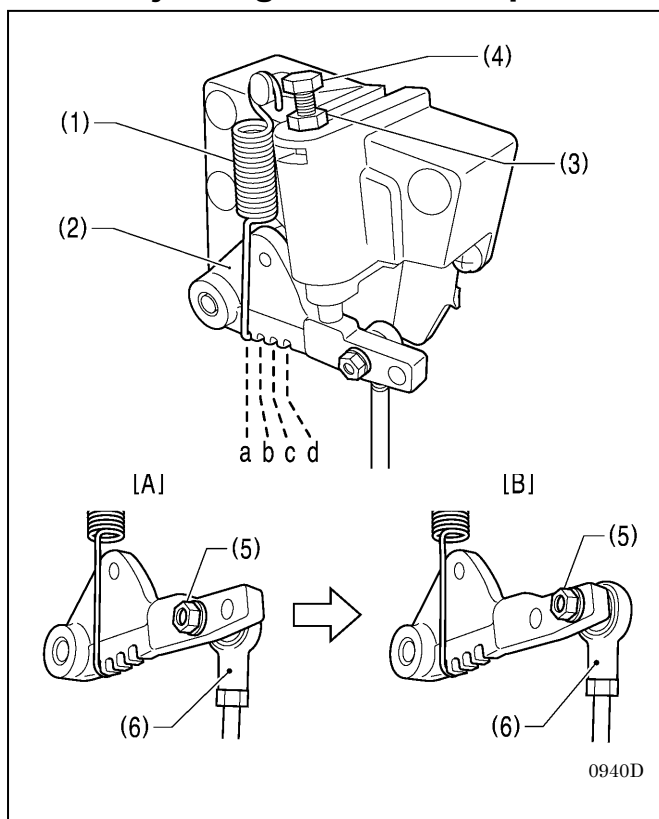

<Forward depression sensitivity adjustment>

If the machine starts running at low speed when your foot is simply resting on the treadle, or if the treadle pressure is felt to be too weak, adjust the position at which the treadle spring (1) is hooked onto the treadle lever (2).

- * a is the weakest position, and it becomes gradually stronger at b, c and d respectively.

<Backward depression sensitivity adjustment>

1. Loosen the nut (3) and turn the bolt (4).

- * When the bolt (4) is tightened, the treadle operation becomes heavier, and when it is loosened, the operation becomes lighter.

2. Tighten the nut (3).

<Adjusting the treadle stroke>

Remove the nut (5), and then move the connecting rod joint (6) from the position in figure A to the position in figure B. The treadle stroke will then be increased by approximately 27 %.

At this time, the treadle forward and backward depression sensitivity will change, so readjust if necessary.

4. PREPARATION BEFORE SEWING

4-1. Installing the needle

CAUTION



Turn off the power switch before installing the needle.
The machine may operate if the treadle is depressed by mistake, which could result in injury.

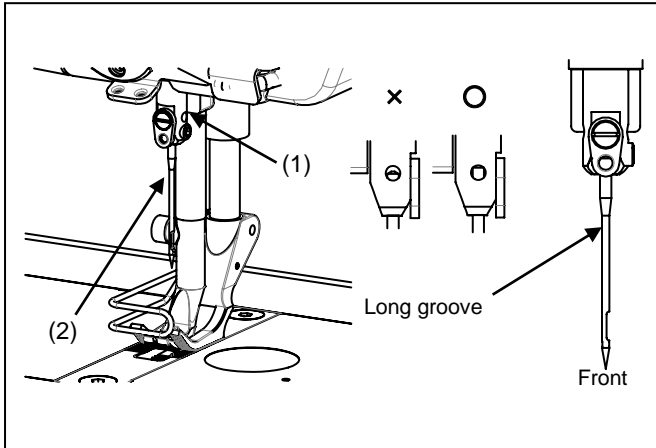

• UF8910 (Single needle)

1. Turn the machine pulley to move the needle bar to its highest position.
2. Loosen the set screw (1).
3. Insert the needle (2) straight in as far as it will go so that the long groove on the needle is at the left, and then securely tighten the set screw (1).

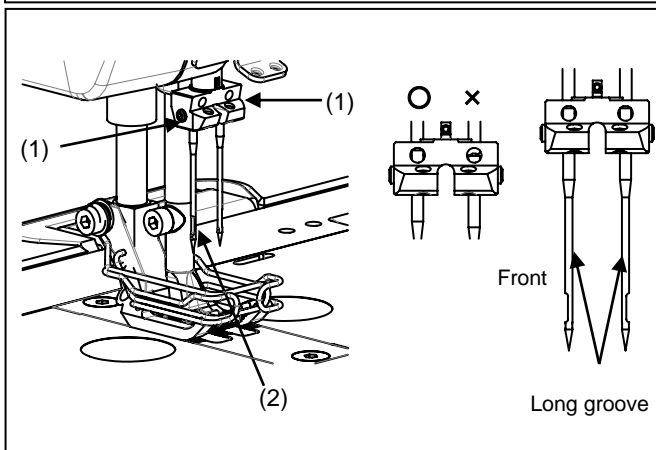

• UF8920 (Twin needle)

1. Loosen the screws (1).
2. Insert the needle (2) straight in as far as it will go so that the long groove is facing inward, and then securely tighten the screws (1).

4-2. Removing the bobbin

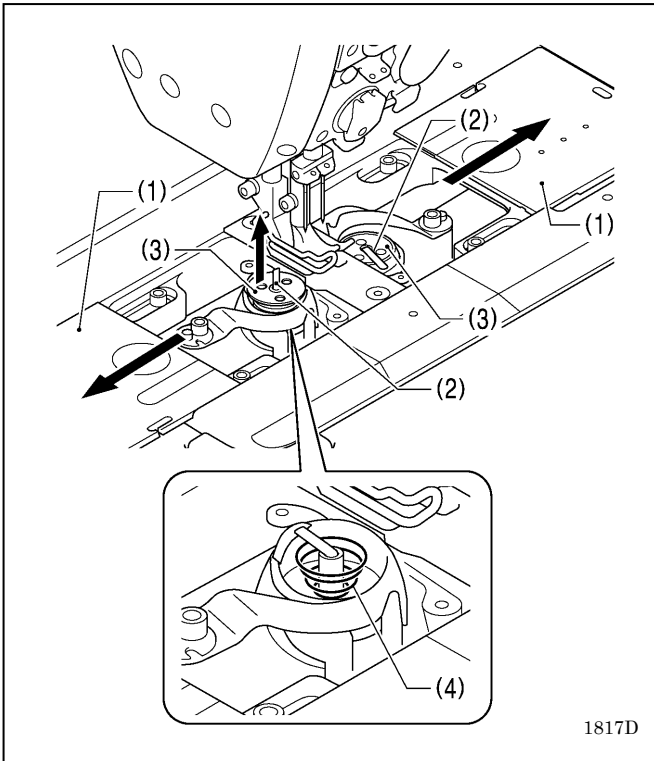
CAUTION**Turn off the power switch before removing the bobbin case.****The machine may operate if the treadle is depressed by mistake, which could result in injury.**

1817D

1. Turn the machine pulley to raise the needle until it is above the needle plate.
2. Open the slide plates (1) by moving them to the right and left.
3. Pull the rotary hook latch (2) upward, and then remove the bobbin (3).

- The anti-spin spring (4) prevents the bobbin from racing at times such as during thread trimming.
- Use bobbins (3) made of light alloy as specified by Brother.

4-3. Winding the lower thread

! CAUTION



Do not touch any of the moving parts or press any objects against the machine while winding the lower thread.
If this is not observed, it may result in serious injury or damage to the sewing machine.

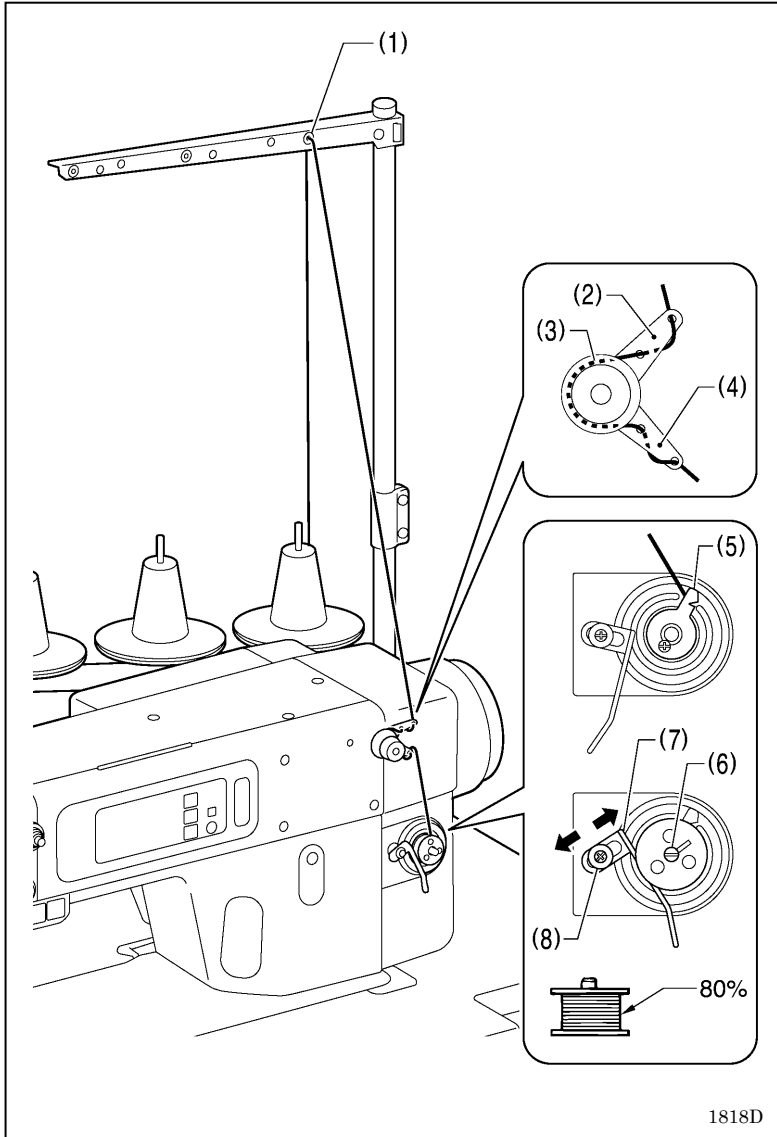

1. Turn on the power switch.
 2. Thread the thread in the order of (1) to (4).
 3. Insert the thread as far as the base of the lower thread clamp knife (5), and then cut the thread with the knife. (The thread end will be held.)
 4. Place the bobbin onto the bobbin winder shaft (6) so that the groove in the bobbin is aligned with the bobbin winder shaft.
 5. When the bobbin presser arm (7) is pushed to the bobbin side, the bobbin will turn and the lower thread will be automatically wound onto the bobbin.
 6. Once winding of the lower thread is completed, the bobbin presser arm (7) will return automatically and the bobbin will stop turning.
 7. After the thread has been wound on, remove the bobbin and cut the thread with the knife of the lower thread clamp (5).
- * Loosen the screw (8) and move the bobbin presser (7) to adjust the amount of thread wound onto the bobbin.

[NOTE]

- The amount of thread wound onto the bobbin should be a maximum of 80 % of the bobbin capacity.
- This is an automatic lower thread winder. When lower thread winding is complete, the bobbin presser arm (7) will automatically return to its initial position.
- If you would like to stop the winding operation before it is complete, return the bobbin presser arm (7) to its initial position. Be careful of the moving parts at this time.
- If the thread is not inserted as far as the lower thread clamp knife, or if the lower thread tension is too strong, the thread may come out at the start of winding. At this time, turn the bobbin clockwise to wind the thread several times onto the bobbin.

4-4. Installing the bobbin

CAUTION

Turn off the power switch before installing the bobbin case.

The machine may operate if the treadle is depressed by mistake, which could result in injury.

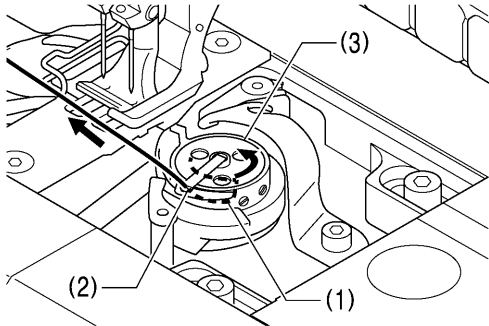

1819D

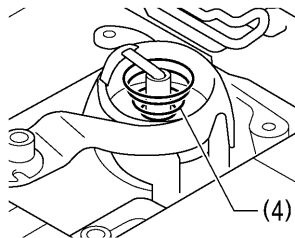
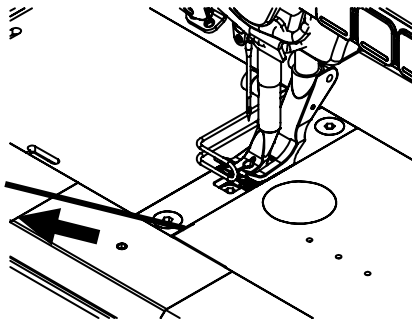

1. Turn the machine pulley to raise the needle until it is above the needle plate.
2. Pass the lower thread through the thread groove (1) in the inner rotary hook and in between the opener and the inner rotary hook (2), and then gently pull the thread to pass it below the tension spring.
 - * Check that the bobbin turns in the direction of the arrow when the thread is pulled.
3. Pull out the thread from the rotary hook to a length of approximately 50 mm.
4. Close the slide plates.

- * If you pull out the lower thread so that it protrude from the gap between the slide plate and the needle plate, it will not pull out easily at the sewing start.

[NOTE]

Do not operate the sewing machine without any material while the bobbin (lower thread) is inserted. It may cause the lower thread to become tangled or cause the rotary hook to become damaged or dislodged.

- The anti-spin spring (4) prevents the bobbin from racing at times such as during thread trimming.
- Use bobbins (3) made of light alloy as specified by Brother.

4-5. Threading the upper thread

CAUTION



Use threading mode or turn off the power first in order to carry out threading.
The machine may operate if the treadle is depressed by mistake, which could result in injury.

Turn the machine pulley to raise the thread take-up (1) before threading the upper thread.
This will make threading easier and it will prevent the thread from coming out at the sewing start.

The accessory threading hose can be used to prevent the upper thread from becoming tangled during sewing.
If it is difficult to insert the thread into the threading hose, widen the opening of the threading hose to make it easier to insert the thread.

It can be useful to use an air blower when passing the thread through the threading hose.
When using an air blower, check the surroundings and operate the trigger gently to pass the thread through.

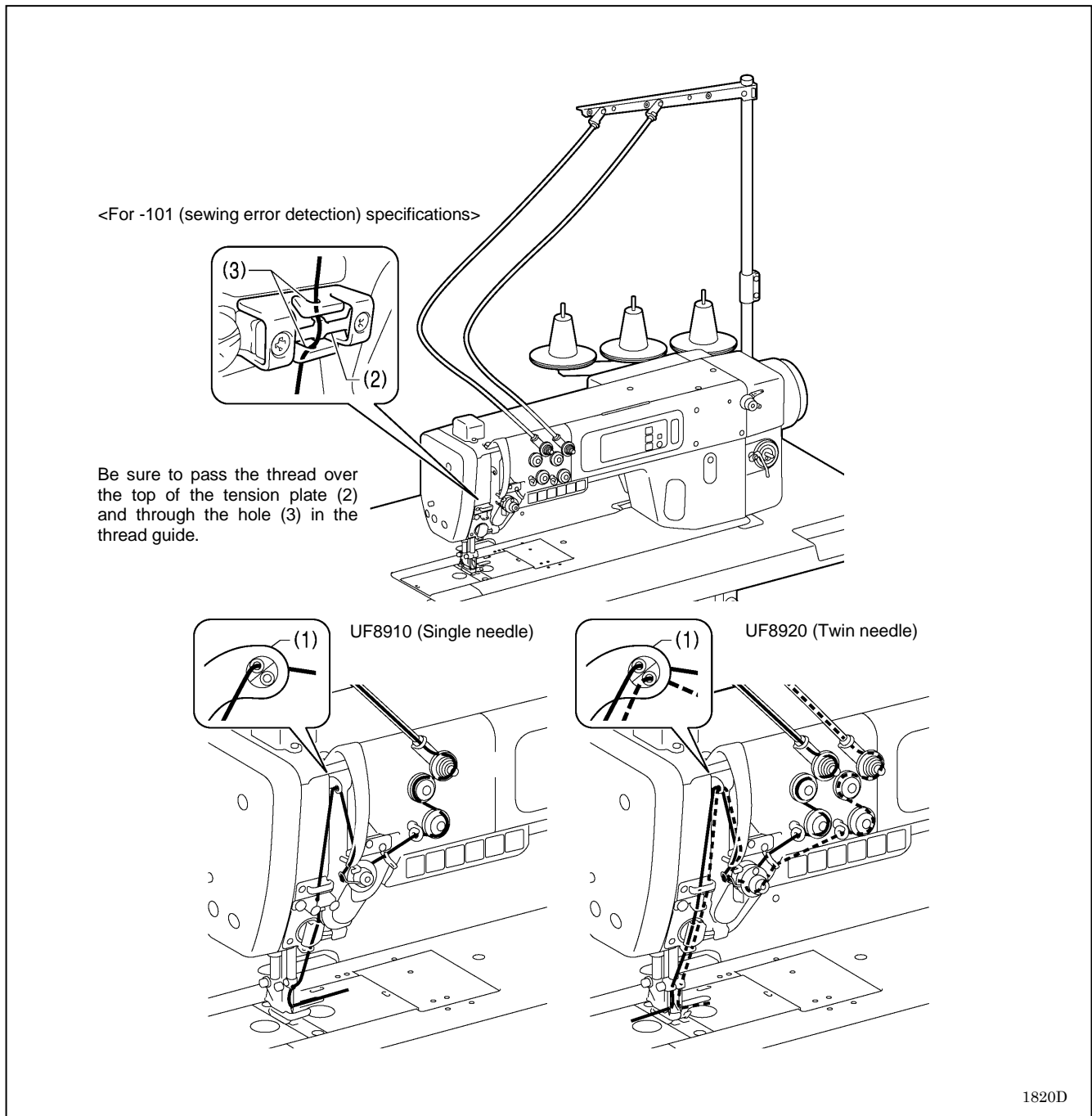

5. USING THE SEWING MACHINE (OPERATION PANEL: BASIC OPERATION)

5-1. Names and functions



- (1) Menu key
This key is used to move to the menu screen.
- (2) Home key
This key is used to return to the home screen.
- (3) F key
Specific functions can be assigned to this key.
- (4) Hold switch
By pressing the hold switch the machine will change to hold mode. The hold mode is used to prevent settings from being changed or the sewing machine from being operated by mistake when the operator has left their seat.
- (5) Touch panel (display)
This displays messages and touch keys (icons).

5-2. Home screen

- The home screen is displayed when the power is turned on.
- Sewing operations are normally carried out while the home screen is displayed.
- The home screen can be switched between the detailed home screen and the simple home screen.
 - * At the time of shipment from the factory, the detailed home screen is set to be displayed.
- If you keep pressing the  key while the home screen is displayed, you can switch between the detailed home screen and the simple home screen.

Furthermore, you can return to the home screen from any other screen by pressing the  key.

Detailed home screen

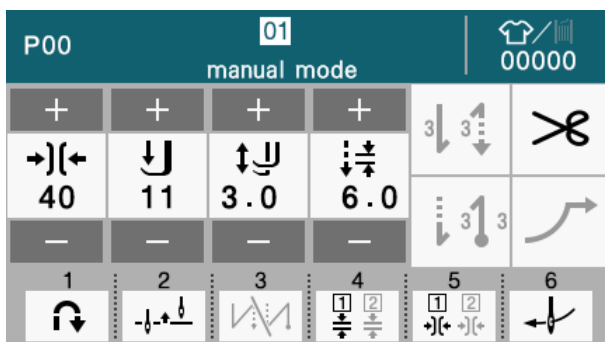

Simple home screen

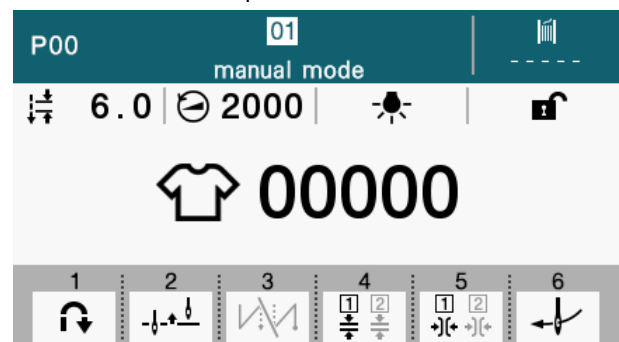

5-2-1. Description of detailed home screen

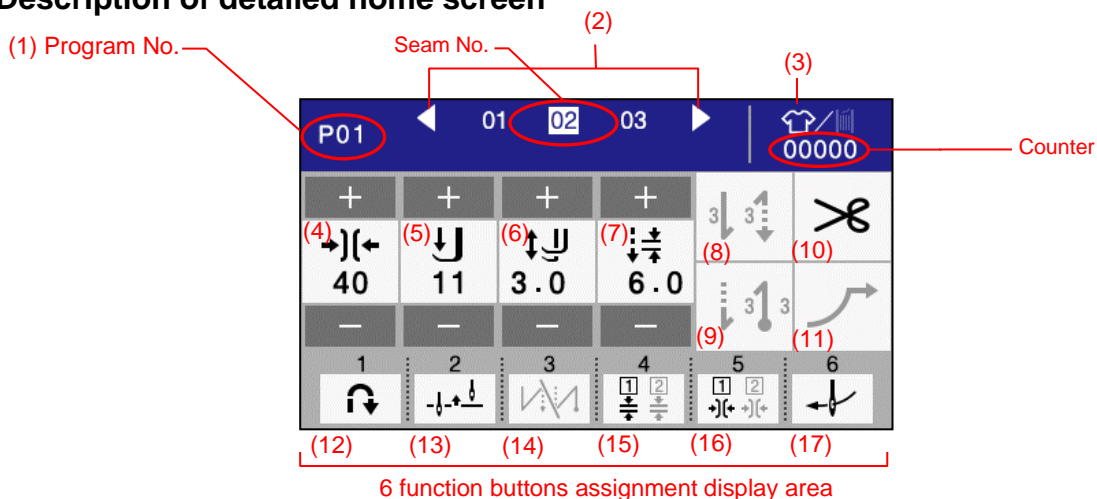

(1)	Program No.	This shows the selected program number. Press this key to change the program number.
(2)	Seam step feed key	This key moves the needle to the next seam.
	Seam step return key	This key returns the needle to the previous seam.
(3)	Counter key	This key switches the type of counter.
(4)	Tension keys	The tension of the upper thread can be changed using the [+] and [-] keys.
(5)	Presser foot pressure keys	The pressure of the presser foot can be changed using the [+] and [-] keys.
(6)	Walking foot stroke keys	The walking foot stroke can be changed using the [+] and [-] keys.
(7)	Main stitch pitch keys	The pitch of the main stitches can be changed using the [+] and [-] keys.
(8)	Start backtack key	This key switches start backtacking on and off.
		When this key is held down, you can make detailed settings.
(9)	End backtack key	This key switches end backtacking on and off.
		When this key is held down, you can make detailed settings.
(10)	Thread trimming key	This key switches the thread wiper on and off.
(11)	Slow start key	This key switches the slow start on and off.
		When this key is held down, you can make detailed settings.
(12)	Reverse key	The sewing direction is reversed while this key is being held down.
(13)	Half stitch key	The main shaft rotates to the needle up or needle down position each time this key is pressed.
(14)	Start and end backtack cancel key	This key cancels start and end backtacking.
(15)	2nd pitch switching key	This key switches the 2nd pitch mode on and off.
(16)	2nd main tension value switching key	This key switches the 2nd main tension mode on and off.
(17)	Threading key	This key switches the sewing machine to threading mode.

* The ranges for (4) to (11) can be changed by assigning the function icons.
(Refer to "7-3. Home screen settings".)

* The key assignments for 6 function buttons (1) to (6) can be changed.
(Refer to "7-4. Assigning functions to the machine head switches".)

5-2-2. Description of simple home screen

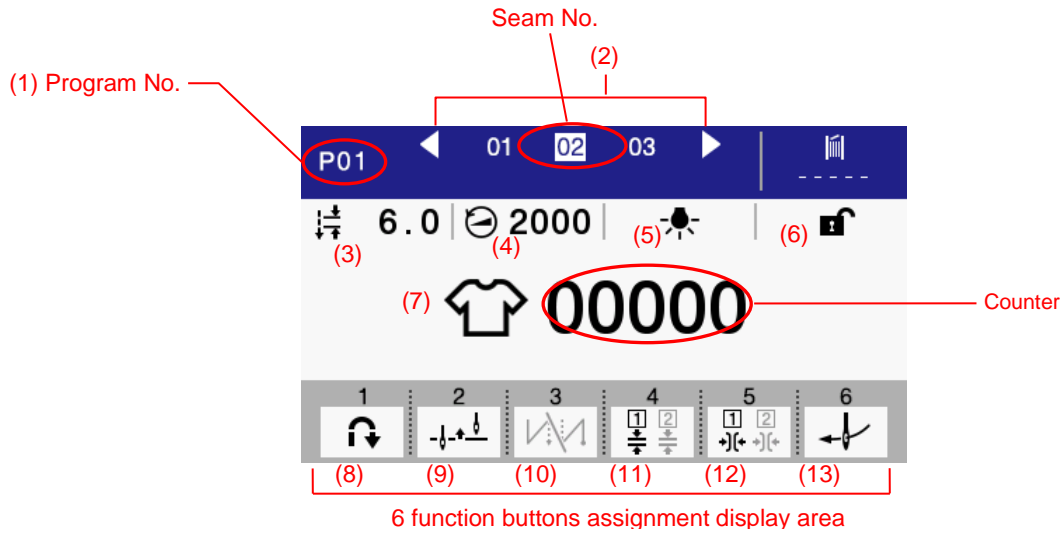

(1)	Program No.	This shows the selected program number. Press this key to change the program number.
(2)	Seam step feed key	This key moves the needle to the next seam.
	Seam step return key	This key returns the needle to the previous seam.
(3)	Main stitch pitch keys	This key switches to the main sewing pitch setting screen.
(4)	Sewing speed keys	This key switches to the main sewing speed setting screen.
(5)	Illumination LED key	This key switches the illumination LED on and off.
(6)	Screen lock/unlock key	Press this key to switch the home screen between locked and unlocked.
(7)	Counter key	This key switches the type of counter.
(8)	Reverse key	The sewing direction is reversed while this key is being held down.
(9)	Half stitch key	The main shaft rotates to the needle up or needle down position each time this key is pressed.
(10)	Start and end backtack cancel key	This key cancels start and end backtacking.
(11)	2nd pitch switching key	This key switches the 2nd pitch mode on and off.
(12)	2nd main tension value switching key	This key switches the 2nd main tension mode on and off.
(13)	Threading key	This key switches the sewing machine to threading mode.



* The key assignments for 6 function buttons (1) to (6) can be changed.
(Refer to "7-4. Assigning functions to the machine head switches".)

5. USING THE SEWING MACHINE (OPERATION PANEL: BASIC OPERATION)



5-2-3. Types of icons

The icons which appear in the display can be broadly classified into the following three types.

Type A: Simple symbols
<Example>

Warning symbol 	USB connector 	Sewing machine 
---	--	---



Type B: Plain touch keys (symbol is always fixed)
<Example>

Return key (Returns to the previous screen) 	+ key (Increases a value) 	OK key (Confirm the value) 
---	---	--

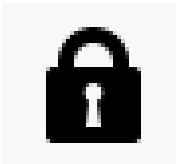
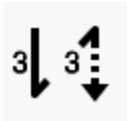
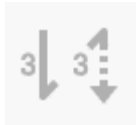
Type C: Touch keys which change their setting status (symbol) each time they are pressed
<Example>

Lock key	Unlocked 	Locked 
Start backtack key	Start backtack enabled 	Start backtack disabled 

5-3. Menu screen

- Press the  key at any screen to return to the menu screen.
- The menu screen consists of the following six screens.
- Press the  key or the  key at a menu screen to change the screen.

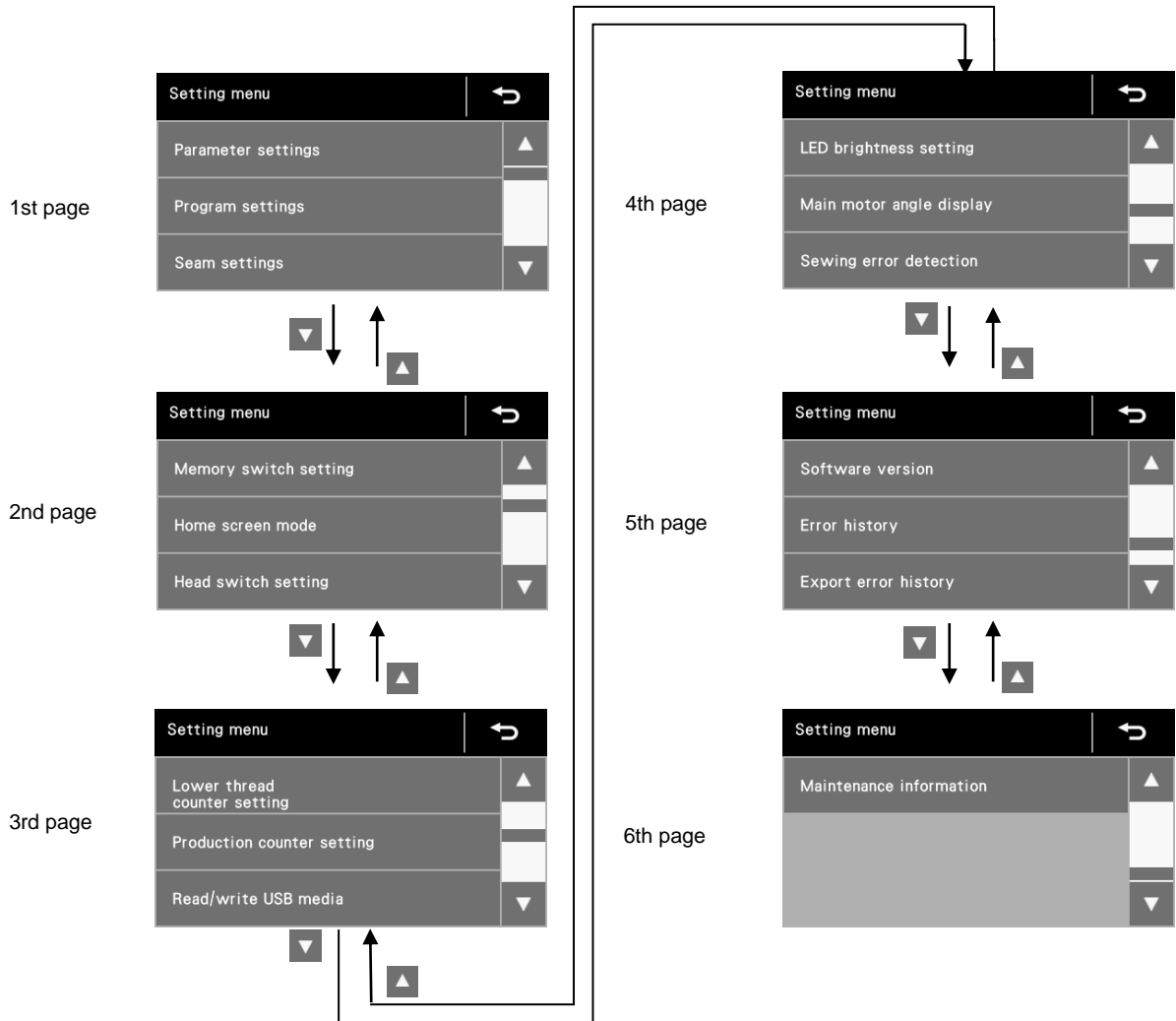

5-4. Program setting method

- It is recommended that you register patterns that are sewn frequently as programs. After programs have been registered, you can retrieve the desired sewing patterns simply by selecting a program number, which eliminates the need to set the pattern each time.
- Settings such as sewing pattern, number of stitches, stitch pitch and sewing speed can be made separately for each program number.
- Up to 15 programs from P01 to P15 can be registered.
 - * P00 is a program number which is used exclusively in manual mode.

5-4-1. Program structure

- A single program consists of program individual functions and up to a maximum of 20 seams, and a single seam can consist of start backtack sewing parameters, main sewing parameters, end backtack sewing parameters and individual functions for that seam.

Programs P00 to P15

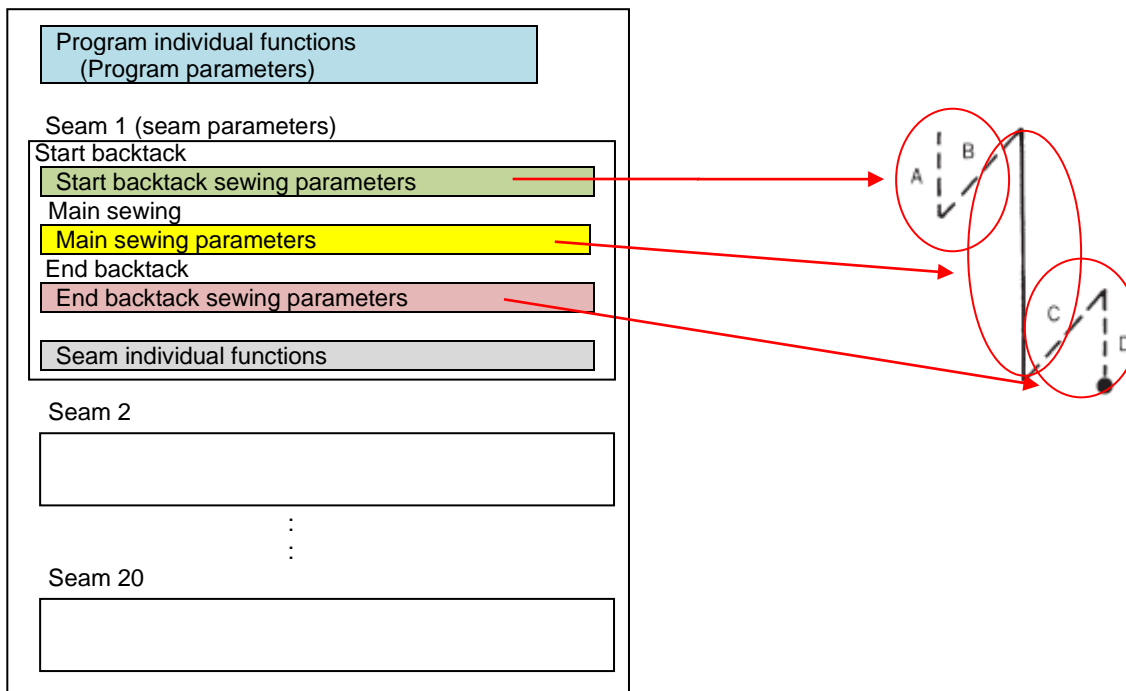

5-4-2. Selecting the sewing start program/seam

- Select a sewing program from the several programs which are available.
- Select a seam to start sewing with from the available programs.
- If sewing is interrupted by a problem such as a thread breakage occurring and you need to resume sewing from the point where sewing was interrupted, you can start sewing from a seam in the middle of a program.

<Switching programs>

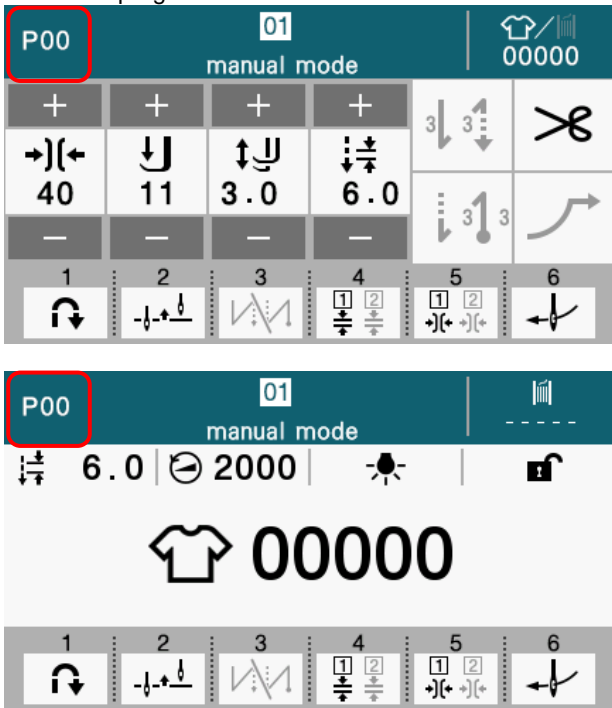
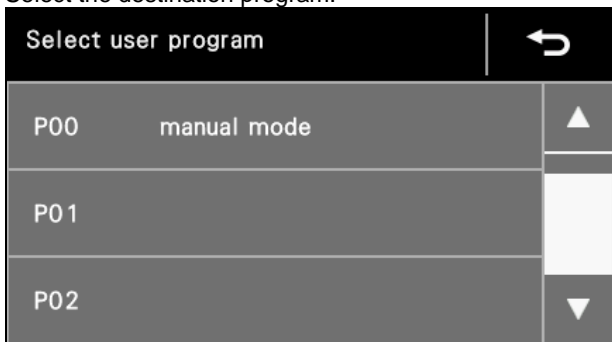
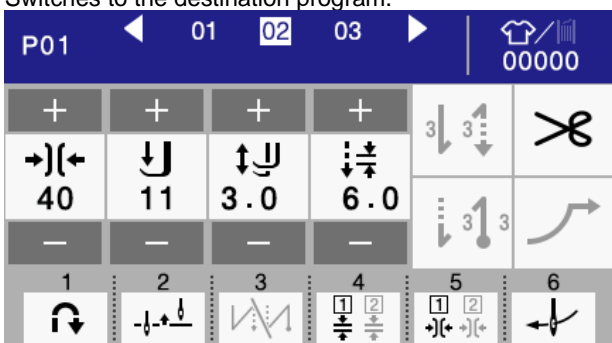
1	<p>Touch the program number.</p> 	<p>From the detailed home screen Touch the program number to switch to the select program screen.</p> <p>From the simple home screen Touch the program number to switch to the select program screen.</p>
2	<p>Select the destination program.</p> 	<p>P00 is a program number which is used exclusively in manual mode. It is used for sewing without creating programs, etc.</p>
3	<p>Switches to the destination program.</p> 	<p>By touching the program, home screen of the destination program will appear.</p>

<Switching seams>

1

Select the seam.

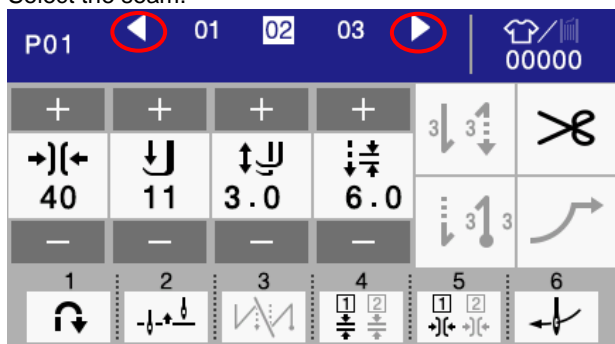

From the detailed home screen

Touch the seam number to select seam screen.

Press the [◀] or [▶] key to display the seam number for the hidden part.

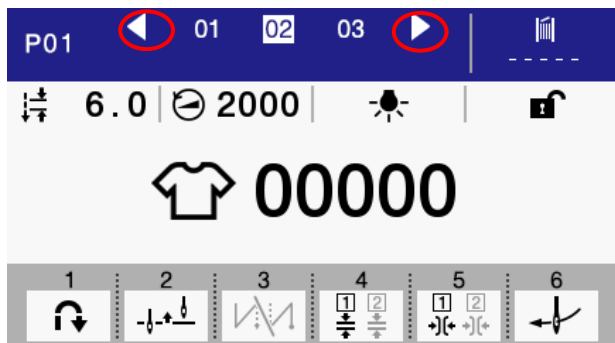

From the simple home screen

Touch the seam number to switch to the select seam screen.





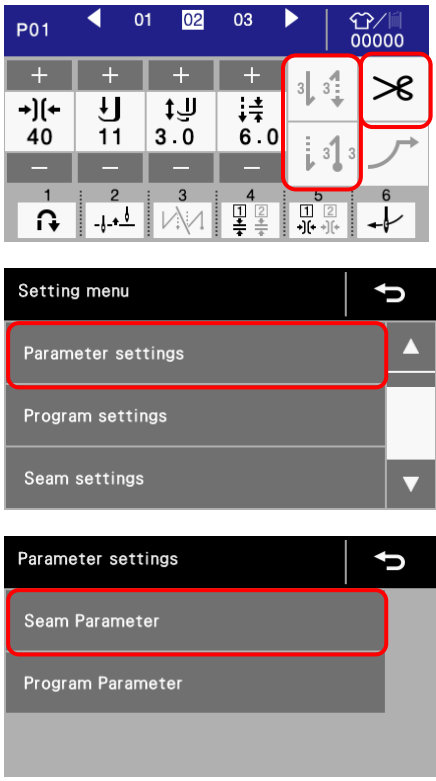
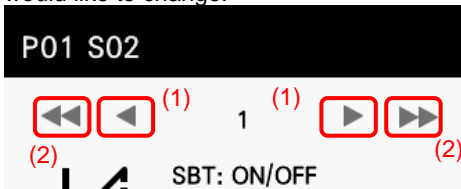
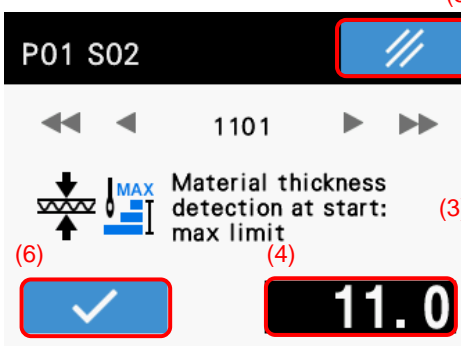

Press the [◀] or [▶] key to display the seam number for the hidden part.

5-4-3. Seam parameter settings













- Move to the seam to be changed, and then set the seam parameters.
- When changing parameters for a different seam, change the seam in the home screen and then make the settings.

<p>1</p>	<p><Switching to seam parameter setting mode></p> 	<p>From the detailed home screen If you touch a key for one of the seam parameters, such as the [Start backtack], [End backtack] or [Thread trimming] key, the display switches to the seam parameter setting screen.</p> <p>From the menu screen After selecting [Parameter settings], select [Seam parameter].</p>
<p>2</p>	<p>Select the parameter number for the parameter that you would like to change.</p> 	<p>Touch the [◀] or [▶] key (1) to select the seam parameter to change.</p> <ul style="list-style-type: none"> • When you touch the [◀◀] or [▶▶] key (2), the parameters which have been changed from default settings will appear in order.
<p>3</p>	<p>Change the setting of the parameter.</p> 	<p>Touch the ▲ key or the ▼ key (3) to change the setting value (4).</p> <ul style="list-style-type: none"> • If no setting value has already been set, the display will blink. <p>You can make the default setting appear in the display by touching the reset key (5).</p> <p>You can touch the check key (6) to check the actual status.</p>

5. USING THE SEWING MACHINE (OPERATION PANEL: BASIC OPERATION)

<p>4</p>	<p>Apply the changed parameter setting.</p> 	<p>Touch the OK key  (7).</p> <ul style="list-style-type: none"> • The setting value (4) will stop blinking and illuminate, and this means that the parameter setting is confirmed. • You can cancel the changes by changing the parameter number or touching the menu key  or the return key  (8) to switch the screen without touching the OK key.
<p>5</p>	<p>Exit setting mode</p> 	<ul style="list-style-type: none"> • Press the return key  or the menu key . • The display will return to the setting menu screen.

Seam parameter list (seam individual functions)

No.	Icon	Setting item	Default value	Minimum value	Maximum value	Change width	Units	Description
0001		Start backtack section: Start backtack ON/OFF	OFF	OFF	ON	1	ON/OFF	Switch start backtack sewing between enabled and disabled
0002		Start backtack section: No. of B stitches	3	1	50	1	No of stitches	No. of stitches in backward direction (B) for start backtack section
0003		Start backtack section: No. of A stitches	3	1	50	1	No of stitches	No. of stitches in forward direction (A) for start backtack section
0004		Start backtack section: No. of times AB sewn	2	0	99	1	No of times	0: A, 1: B, 2: AB, 3: BAB,...
0005		Start backtack section: Stop-time for direction change	0	0	1000	50	ms	Pause time for motor reverse operation at start backtack section
0006		Start backtack section: Using the stitch length of manual mode	OFF	OFF	ON	1	ON/OFF	ON: Pitch used at A and B is the pitch set for manual mode OFF: The value for 0007 is used for the B section The value for 0008 is used for the A section
0007		Start backtack section: Pitch of B	6.0	1.0	12.0 [*1]	0.1	–	B section pitch
0008		Start backtack section: Pitch of A	6.0	1.0	12.0 [*1]	0.1	–	A section pitch
0009		Start backtack section: Speed	1000	70	2000 [*2]	100	sti/min	Speed for sewing start backtack section
0011		Start backtack section: Using the main tension of manual mode	OFF	OFF	ON	1	ON/OFF	ON: The tension which has been set in manual mode is used OFF: The value for 0012 is used for the left The value for 0013 is used for the right *3
0012		Start backtack section: Main tension L	40	0	100	1	–	Tension value for left-side upper thread
0013		Start backtack section: Main tension R	40	0	100	1	–	Tension value for right-side upper thread

5. USING THE SEWING MACHINE (OPERATION PANEL: BASIC OPERATION)

No.	Icon	Setting item	Default value	Minimum value	Maximum value	Change width	Units	Description
0023		Start backtack section: Walking foot stroke	3.0	1.5	9.0	0.5	–	Walking foot stroke amount
0051		End backtack section: End backtack ON/OFF	OFF	OFF	ON	1	ON/OFF	Switch end backtack sewing between enabled and disabled
0052		End backtack section: No. of C stitches	3	1	50	1	No of stitches	No. of stitches in forward direction (C) for end backtack section
0053		End backtack section: No. of D stitches	3	1	50	1	No of stitches	No. of stitches in backward direction (D) for end backtack section
0054		End backtack section: No. of CD stitches	2	0	99	1	No of times	0: D, 1: C, 2: CD, 3: CDC,
0055		End backtack section: Stop-time for direction change	0	0	1000	50	ms	Pause time for motor reverse operation at end backtack section
0056		End backtack section: Using the stitch length of manual mode	ON	OFF	ON	1	ON/OFF	ON: Pitch used at C and D is the pitch set for manual mode OFF: The value for 0057 is used for the C section The value for 0058 is used for the D section
0057		End backtack section: Pitch of D	6.0	1.0	12.0 [*1]	0.1	–	C section pitch
0058		End backtack section: Pitch of C	6.0	1.0	12.0 [*1]	0.1	–	D section pitch
0059		End backtack section: Speed	1000	70	2000 [*4]	100	sti/min	Speed for sewing end backtack section
0061		End backtack section: Using the main tension of manual mode	OFF	OFF	ON	1	ON/OFF	ON: The tension which has been set in manual mode is used OFF: The value for 0062 is used for the left The value for 0063 is used for the right *3
0062		End backtack section: Main tension L	40	0	100	1	–	Tension value for left-side upper thread
0063		End backtack section: Main tension R	40	0	100	1	–	Tension value for right-side upper thread
0073		End backtack section: Walking foot stroke	3.0	0.5	9.0	0.5	–	Walking foot stroke amount
0100		SEAM: Needle thread clamp	OFF	OFF	ON	1	ON/OFF	ON: Thread holder operates OFF: Thread holder does not operate
0101		Main section: Direction of sewing	0	0	1	1	1	0: Forward feed 1: Backward feed
0102		Main section: No. of stitches	0	0	99	1	No of stitches	0: No limit 1--: No. of fixed stitches
0104		Main section: Speed	2000	70	[*5]	100	sti/min	Speed for sewing main section
0105		Main section: Pitch	6.0	0.1	12.0 [*1]	0.1	–	Stitch length for sewing main section
0106		Main section: Walking foot stroke	3.0	1.5	9.0	0.5	–	Walking foot stroke amount
0107		Main section: Presser foot pressure	11	0	20	1	–	Presser foot pressure value
0108		Main section: Height of presser foot	18	1	20 [*6]	1	–	Presser foot lifter height during standby

5. USING THE SEWING MACHINE (OPERATION PANEL: BASIC OPERATION)

No.	Icon	Setting item	Default value	Minimum value	Maximum value	Change width	Units	Description
0109		Main section: Main tension L	40	0	100	1	–	Tension value for left-side upper thread
0110		Main section: Main tension R	40	0	100	1	–	Tension value for right-side upper thread
0111		Main section: Needle position when paused during sewing	OFF	OFF	ON	1	ON/OFF	Needle position when sewing is paused ON: Needle up OFF: Needle down
0112		Main section: Height of presser foot lift during sewing	18	1	20 [*6]	1	–	Presser foot lifter height when sewing is paused
0113		Main section: Presser foot lift at sewing stop	2	OFF	3	1	–	0: OFF while sewing is paused OFF when stopped after thread trimming 1: ON while sewing is paused OFF when stopped after thread trimming 2: OFF while sewing is paused ON when stopped after thread trimming 3: ON while sewing is paused ON when stopped after thread trimming
0114		Main section: Auto sewing	OFF	OFF	ON	1	ON/OFF	Enabled during fixed stitch sewing OFF: Function disabled 1: Sewing does not stop until sewing the set number of stitches is completed, even if the treadle is not continuously depressed forward 2: Sewing continues until the set number of stitches have been sewn, even if the treadle is not continuously depressed forward, and then (end backtack sewing is carried out if it has been set, and then) the thread is trimmed*. * Whether thread trimming is carried out or not depends on S0200.
0200		Seam: Thread trimmer	ON	OFF	ON	1	ON/OFF	ON: Thread trimming is enabled OFF: Thread trimming is disabled * Thread trimming is carried out and the thread trimmer solenoid operation switches ON/OFF
0721		Seam: Needle position at end point	ON	OFF	ON	1	ON/OFF	OFF: Needle down when seam is completed Stopped ON: Needle up when seam is completed Stopped
1100		Material thickness detection at start: mode	OFF	OFF	2	1	–	OFF: Function disabled 1: If material is outside the thickness range, sewing start is not possible 2: If material is outside the thickness range, sewing start is possible after the warning is cleared
1101		Material thickness detection at start: max limit	12.0	0.0	12.0	0.1	–	Upper thickness limit value for material for which sewing start is possible
1102		Material thickness detection at start: max limit correction	0.0	-1.0	1.0	0.1	–	Correction value for upper thickness limit value for material for which sewing start is possible
1103		Material thickness detection at start: min limit	1.0	0.0	12.0	0.1	–	Lower thickness limit value for material for which sewing start is possible

5. USING THE SEWING MACHINE (OPERATION PANEL: BASIC OPERATION)

No.	Icon	Setting item	Default value	Minimum value	Maximum value	Change width	Units	Description
1104		Material thickness detection at start: min limit correction	0.0	-1.0	1.0	0.1	–	Correction value for lower thickness limit value for material for which sewing start is possible

[*1] Determined by memory switch No. 261

[*2] Determined by memory switch Nos. 184 and 189

[*3] Does not appear when using manual mode. Settings of memory switch No. 405 will be used.

[*3] Determined by memory switch Nos. 186 and 189

[*4] Determined by memory switch No. 189

[*5] Determined by memory switch No. 058

5-4-4. Program parameter settings

- Move to the program to be changed, and then set the program parameters.
- When changing parameters for a different program, change the seam in the home screen and then make the settings.

1 <Switching to program parameter setting mode>

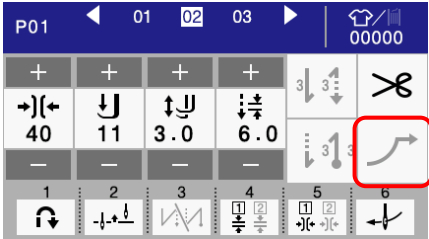

From the detailed home screen
If you touch a key for one of the program parameters, such as the [Slow start] key, the display switches to the program parameter setting screen.

From the menu screen
After selecting [Parameter settings], select [Program parameter].

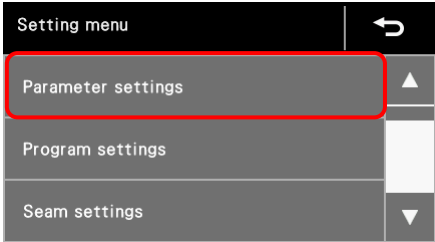
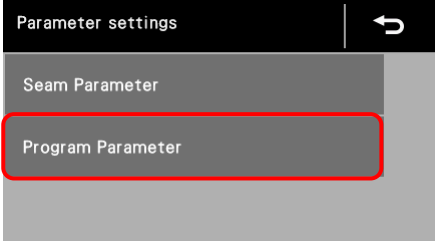
2 Select the parameter number for the parameter that you would like to change.

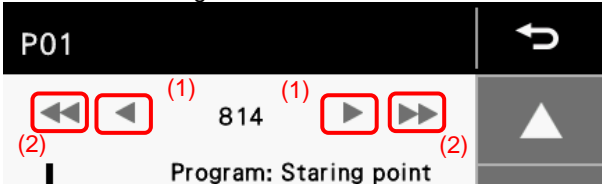

Touch the [◀] or [▶] key (1) to select the seam parameter to change.

- When you touch the [◀◀] or [▶▶] key (2), the parameters which have been changed from default settings will appear in order.

3 Change the setting of the parameter.









Touch the ▲ key or the ▼ key (3) to change the setting value (4).

- If no setting value has already been set, the display will blink.



You can make the default setting appear in the display by touching the reset key (5).

You can touch the check key (6) to check the actual status.





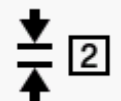
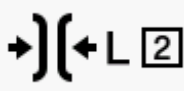
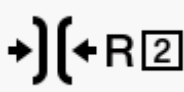
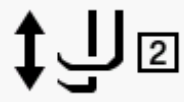

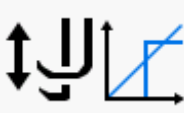

5. USING THE SEWING MACHINE (OPERATION PANEL: BASIC OPERATION)

4	<p>Apply the changed parameter setting.</p> 	<p>Touch the OK key  (7).</p> <ul style="list-style-type: none"> · The setting value (4) will stop blinking and illuminate, and this means that the parameter setting is confirmed. · You can cancel the changes by changing the parameter number or touching the menu key  or the return key  (8) to switch the screen without touching the OK key.
5	<p>Exit setting mode</p> 	<p>Press the return key  or the menu key .</p> <ul style="list-style-type: none"> · The display will return to the setting menu screen.





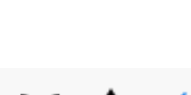

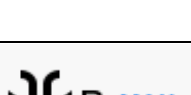
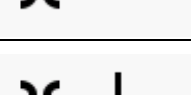

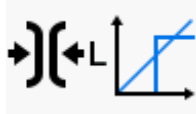

Program parameters (Program individual functions)

No.	Icon	Setting item	Default value	Minimum value	Maximum value	Change width	Units	Description
0814		Prog: Starting point	0	0	359	1	deg	Main shaft angle specified by needle drop alignment function
0815		Prog: 2nd pitch	6.0	0.1	12.0 [*1]	0.1	–	2nd pitch
0902		Prog: 2nd tension L	40	0	100	1	–	2nd tension
0912		Prog: 2nd tension R	40	0	100	1	–	2nd tension (right side)
1002		Prog: 2nd walking foot stroke	3.0	1.5	9.0	0.5	–	2nd walking foot stroke
2700		Material thickness correction: X-over seam assist mode setting	OFF	OFF	ON	1	–	OFF: X-over seam assist OFF ON: X-over seam assist ON
2701		Material thickness correction: Adjustment acceptable range	0.2	0	2.0	0.1	–	Hysteresis in material thickness (detection tolerance) when correction is carried out due to material thickness
2710		Material thickness correction: X-over seam walking foot stroke mode	OFF	OFF	3	1	–	Correction method for walking foot stroke corresponding to material thickness OFF: No correction 1: Linear correction 2: Switch to 2nd walking foot stroke (1002) and return to normal 3: Switch to 2nd walking foot stroke (1002)



5. USING THE SEWING MACHINE (OPERATION PANEL: BASIC OPERATION)

No.	Icon	Setting item	Default value	Minimum value	Maximum value	Change width	Units	Description
2711		Material thickness correction: X-over seam walking foot stroke maximum	3.0	1.5	9.0	0.5	–	Presser foot height when material thickness reaches the threshold value upper limit (2713)
2712		Material thickness correction: X-over seam walking foot stroke threshold minimum limit	3.0	0.0	10.0	0.1	–	Lower limit of material thickness for walking foot stroke correction to start (Correction is carried out when the thickness is greater than this)
2713		Material thickness correction: X-over seam walking foot stroke threshold maximum limit	6.0	0.0	10.0	0.1	–	Upper limit of material thickness for walking foot stroke correction to be carried out (2711 applies when over this thickness)
2720		Material thickness correction: X-over seam pitch mode	OFF	OFF	3	1	–	Correction method for sewing pitch corresponding to material thickness OFF: No correction 1: Linear correction 2: Switch to 2nd pitch (0815) and return to normal 3: Switch to 2nd pitch (0815)
2721		Material thickness correction: X-over seam pitch maximum	90	50	150	1	%	Pitch correction ratio when material thickness reaches upper limit (2722)
2722		Material thickness correction: X-over seam pitch threshold minimum limit	3.0	0.0	10.0	0.1	–	Lower limit of material thickness for pitch correction to start (Correction is carried out when the thickness is greater than this)
2723		Material thickness correction: X-over seam pitch threshold maximum limit	6.0	0.0	10.0	0.1	–	Upper limit of material thickness for pitch correction to be carried out (2721 applies when over this thickness.)
2730		Material thickness correction: X-over seam right tension mode	OFF	OFF	3	1	–	Correction method for right-side main tension corresponding to material thickness OFF: No correction 1: Linear correction 2: Switch to 2nd tension (0912) and return to normal 3: Switch to 2nd tension (0912)
2731		Material thickness correction: X-over seam right tension maximum	50	0	90	1	%	Right-side main tension correction ratio when material thickness reaches upper limit (2733)
2732		Material thickness correction: X-over seam right tension threshold minimum limit	3.0	0.0	10.0	0.1	–	Lower limit of material thickness for right-side main tension correction to start (Correction is carried out when the thickness is greater than this)
2733		Material thickness correction: X-over seam right tension threshold maximum limit	6.0	0.0	10.0	0.1	–	Upper limit of material thickness for right-side main tension correction to be carried out (2731 applies when over this thickness)

5. USING THE SEWING MACHINE (OPERATION PANEL: BASIC OPERATION)

No.	Icon	Setting item	Default value	Minimum value	Maximum value	Change width	Units	Description
2740		Material thickness correction: X-over seam left tension mode	OFF	OFF	3	1	–	Correction method for left-side main tension corresponding to material thickness OFF: No correction 1: Linear correction 2: Switch to 2nd tension (0902) and return to normal 3: Switch to 2nd tension (0902)
2741		Material thickness correction: X-over seam left tension maximum	50	0	90	1	%	Left-side main tension correction ratio when material thickness reaches upper limit (2743)
2742		Material thickness correction: X-over seam left tension threshold minimum limit	3.0	0.0	10.0	0.1	–	Lower limit of material thickness for left-side main tension correction to start (Correction is carried out when the thickness is greater than this)
2743		Material thickness correction: X-over seam left tension threshold maximum limit	6.0	0.0	10.0	0.1	–	Upper limit of material thickness for left-side main tension correction to be carried out (Correction is carried out when this thickness is exceeded)
2750		Material thickness correction: X-over seam pressure mode	OFF	OFF	1	1	–	Correction method for presser foot pressure corresponding to changes in material thickness OFF: Correction OFF 1: Linear
2751		Material thickness correction: X-over seam pressure maximum	0	0	20	1	–	Presser foot pressure when material thickness reaches the upper limit (2753)
2752		Material thickness correction: X-over seam pressure threshold minimum limit	3.0	0.0	10.0	0.1	–	Lower limit of material thickness for presser foot pressure correction to start (Correction is carried out when the thickness is greater than this)
2753		Material thickness correction: X-over seam pressure threshold maximum limit	6.0	0.0	10.0	0.1	–	Upper limit of material thickness for presser foot pressure correction to be carried out (2751 applies when over this thickness)
2760		Material thickness correction: X-over seam speed mode	OFF	OFF	1	1	–	Correction method for speed corresponding to changes in material thickness OFF: Correction OFF 1: Linear
2761		Material thickness correction: X-over seam speed maximum	1500	300	3800 [*2]	100	sti/min	Main shaft speed when material thickness reaches upper limit (2763)
2762		Material thickness correction: X-over seam speed threshold minimum limit	3.0	0.0	10.0	0.1	–	Lower limit of material thickness for presser foot pressure correction to start (Correction is carried out when the thickness is greater than this)

5. USING THE SEWING MACHINE (OPERATION PANEL: BASIC OPERATION)

No.	Icon	Setting item	Default value	Minimum value	Maximum value	Change width	Units	Description
2763		Material thickness correction: X-over seam speed threshold maximum limit	6.0	0.0	10.0	0.1	–	Upper limit of material thickness for presser foot pressure correction to be carried out (2761 applies when over this thickness.)
4000		Slow start	OFF	OFF	ON	1	ON/OFF	Slow start set by memory switch Nos. 470 to 473 OFF: Disabled ON: Enabled

[*1] Determined by memory switch No. 261

[*2] Determined by memory switch No. 189

5-5. Using the lower thread counter (stitch counter)

- The lower thread counter can be used to let you know approximately how much lower thread is remaining.
 - * The lower thread counter should be used as a guide only.
- The value displayed by the lower thread counter display is reduced by 1 from the default setting value, and a warning is given when the counter reaches "0".
- The initial value for the lower thread counter is the counter for the number of stitches. Administrator privileges are required in order to change this setting.

<Initial value setting>

1 The mode will switch to lower thread counter setting mode.

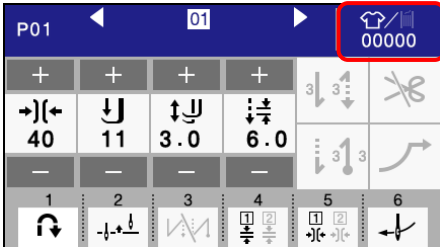

From the detailed home screen
Set the counter display so that it is displaying the [Lower thread counter] icon, and then hold down the [Lower thread] key to switch to lower thread counter setting mode.

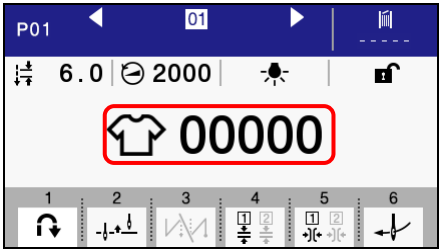

From the simple home screen
Hold down the [Lower thread] key to switch to lower thread counter setting mode.

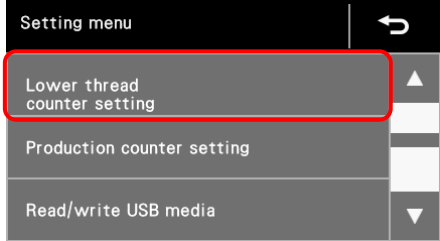

From the menu screen
Select "Lower thread counter setting" to switch to lower thread counter setting mode.

2 Change the counter value.

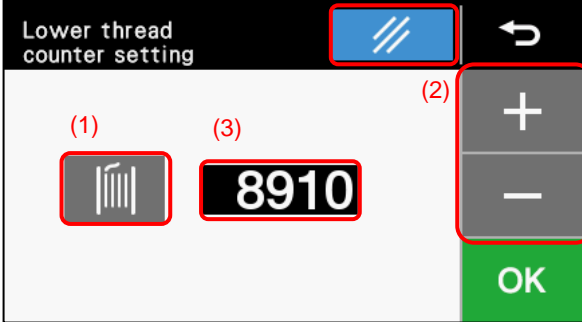

<When turned off>

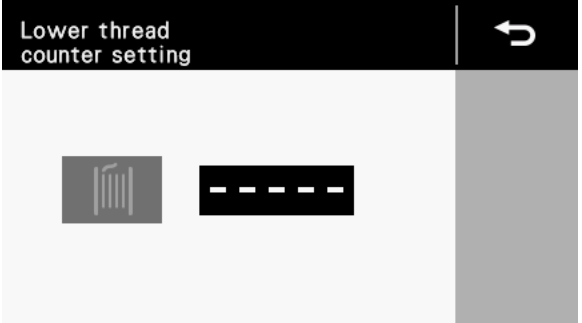

You can use the [Lower thread] key (1) to turn the counter function on and off.

- * When the function is turned off, "---" will appear in the counter display (1) and the counter will not operate while sewing is carried out.

Touch the **+** key or the **-** key (2) to change the counter value (3).

- The initial value can be set from once ("0001") to 9999 times ("9999").
- Only if the counter function is turned on, you can press the reset key **///** (4) to provisionally reset the value to the one which was set previously.

5. USING THE SEWING MACHINE (OPERATION PANEL: BASIC OPERATION)

3

Apply the changed parameter setting.

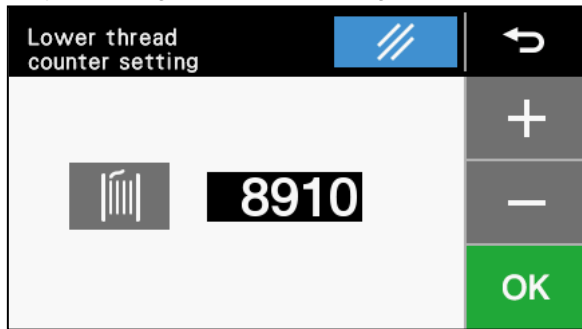

Touch the OK key .

- The value will be confirmed and the display will return to the home screen.
- If you touch the return key  without touching the OK key, you can cancel the changes.

<Lower thread counter operation>

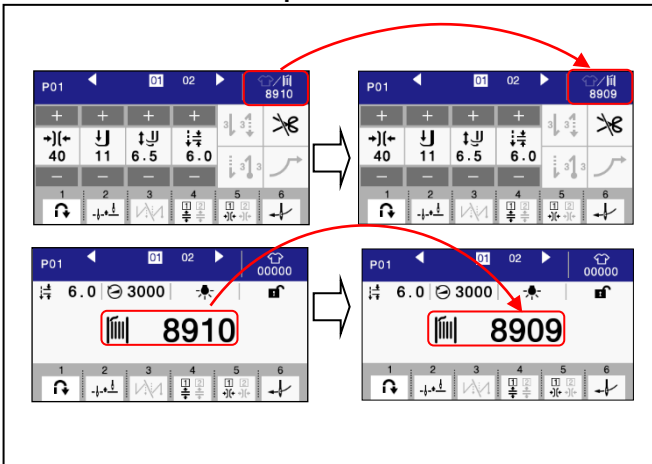

When sewing is carried out, the value shown in the lower thread counter display is reduced by 1 for every 1000 stitches sewn.

- * The units for the number of stitches can be changed using memory switch No. 355.

<Lower thread out warning when sewing stops (before thread trimming) (when memory switch No. 300 is set to "1")>

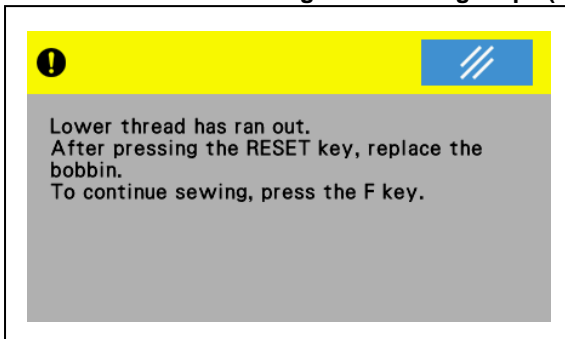

1. If the lower thread counter has dropped to "0" or less when the sewing machine stops sewing, the warning buzzer sounds, and a lower thread counter warning message is displayed.
 - * Sewing will not be possible even if the treadle is depressed forward.
2. <If replacing the bobbin>
 - (1) Press the reset key.
 - * The lower thread counter value will return to the value which was previously set.
 - (2) Depress the treadle backward to trim the thread.
 - (3) Replace the bobbin.
 - <If not replacing the bobbin>
 - (1) Press the F key.
 - * The lower thread counter value will remain unchanged.
3. The display will return to the screen which was being displayed before the lower thread counter out warning appeared, and sewing will be possible.



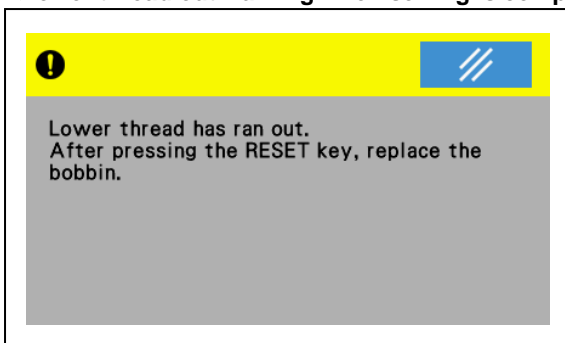

<Lower thread out warning when sewing is complete (after thread trimming) (other than above)>



1. If the lower thread counter has dropped to "0" or less when sewing is completed, the warning buzzer sounds, and a lower thread counter warning message is displayed.
 - * Sewing will not be possible even if the treadle is depressed forward.
2. Press the reset key.
 - The lower thread counter value will return to the value which was previously set.
3. Replace the bobbin.
4. The display will return to the screen which was being displayed before the lower thread counter out warning appeared, and sewing will be possible.

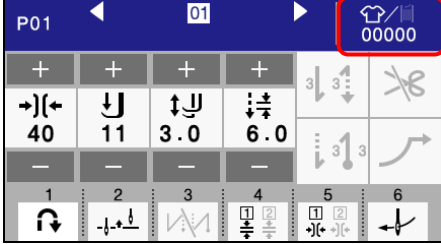
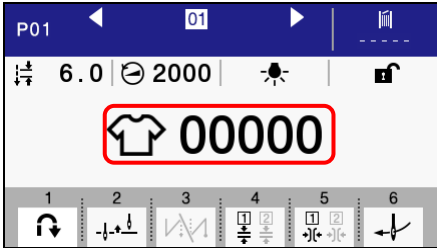
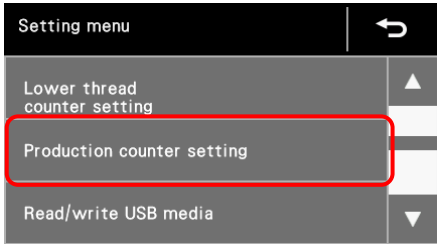
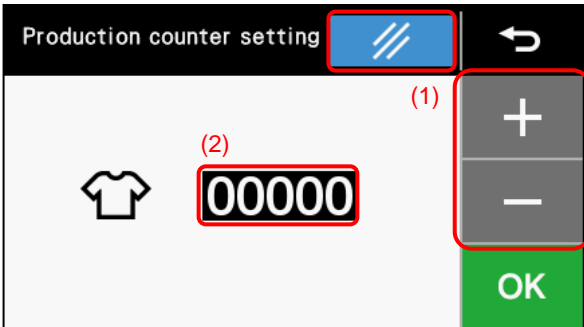

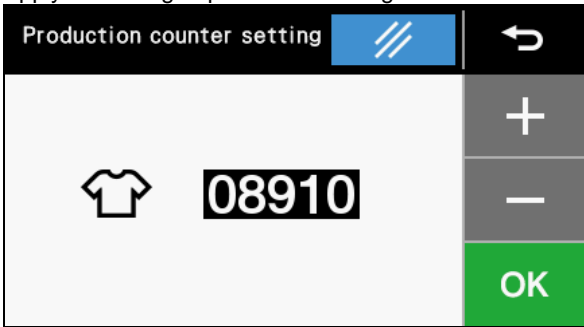



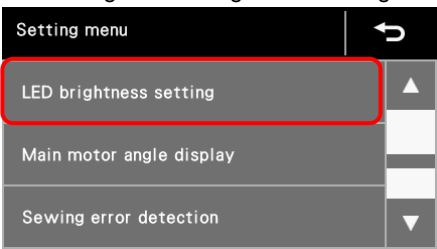
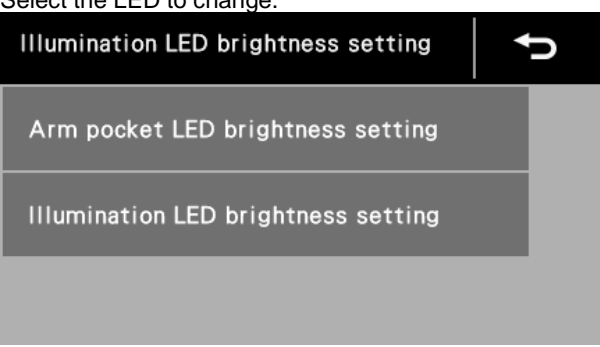
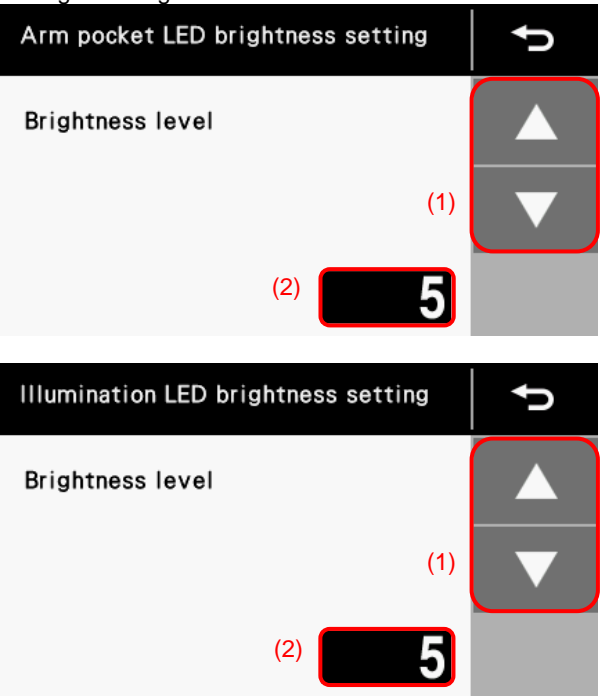

5-6. Using the production counter

- The production counter can be used to let you know how many items have been sewn.
- The production counter increases by 1 each time thread trimming is carried out.

1	<p>The mode will switch to production counter setting mode.</p>  <p>From the detailed home screen Set the counter display so that it is displaying the [Production counter] icon, and then hold down the [Production] key to switch to production counter setting mode.</p>  <p>From the simple home screen Hold down the [Production] key to switch to production counter setting mode.</p>  <p>From the menu screen Select "Production counter setting" to switch to production counter setting mode.</p>	
2	<p>Change the counter value.</p>  <p>Touch the + key or the - key (1) to change the counter value (2).</p> <ul style="list-style-type: none"> • The counter value can be set to a value from "00000" to "99999". • If you press the reset key  (3) during setting mode, the value will become "00000". 	
3	<p>Apply the changed parameter setting.</p>  <p>Touch the OK key .</p> <ul style="list-style-type: none"> • The value will be confirmed and the display will return to the home screen. • If you touch the return key  without touching the OK key, you can cancel the changes. 	

5-7. Setting the LED brightness



The brightness of the arm LED and illumination LED can be set.

<p>1</p>	<p><Switching to LED brightness setting mode></p> 	<p>From the menu screen Select "LED brightness setting" to switch to LED brightness setting mode.</p>
<p>2</p>	<p>Select the LED to change.</p> 	<p>The brightness of the arm pocket LED and the illumination LED can be set separately.</p>
<p>3</p>	<p>Change the brightness.</p> 	<p>Touch the  key or the  key (1) to set the value for the brightness level (2). The setting range is from 0 to 9.</p> <ul style="list-style-type: none"> You can cancel the changes by touching the menu key  or the return key  to switch the screen.
<p>4</p>	<p>Exit setting mode</p> 	<p>Press the return key  or the menu key .</p> <ul style="list-style-type: none"> The display will return to the setting menu screen.

6. USING THE SEWING MACHINE (SEWING OPERATION)

6-1. Changing the sewing pitch

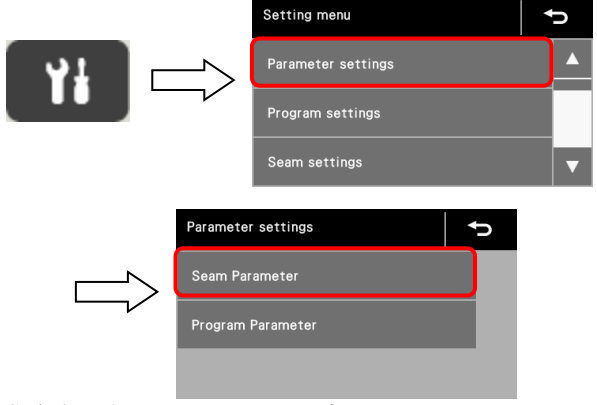
- The larger the number, the longer the stitch length will be.
- The numbers are for use as a guide. The length of the finished stitches may vary depending on the type and thickness of material being sewn. Adjust after checking the finished stitches.

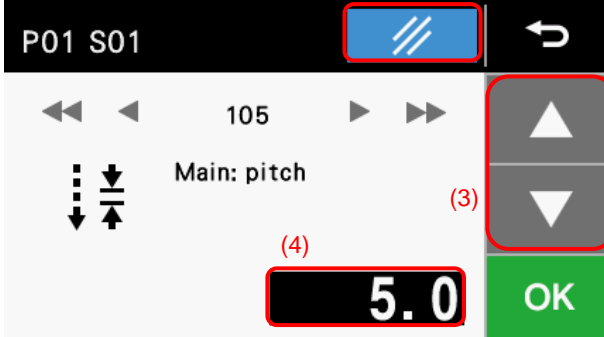
<p>1</p>	<p>Switch to the seam parameter setting screen.</p> 	<p>Press the menu key to switch to the setting menu. Touch [Parameter settings] in the setting menu, and then touch [Seam parameter].</p>  <p>Switch to the seam parameter setting screen.</p>
<p>2</p>	<p>Select the parameter number for the parameter that you would like to change.</p> 	<p>Touch the [◀] or [▶] key (1) to select "Main: pitch".</p> <ul style="list-style-type: none"> • When you touch the [◀◀] or [▶▶] key (2), the parameters which have been changed from initial settings will appear in order.
<p>3</p>	<p>Change the setting of the parameter.</p> 	<p>Touch the ▲ key or the ▼ key (3) to change the setting value (4).</p> <ul style="list-style-type: none"> • If no setting value has already been set, the display will blink. <p>You can make the initial setting appear in the display by touching the reset key (5).</p>

6. USING THE SEWING MACHINE (SEWING OPERATION)

<p>4</p>	<p>Apply the changed setting.</p>	<p>Touch the OK key (6).</p> <ul style="list-style-type: none"> • The setting value (4) will stop blinking and illuminate, and this means that the parameter setting is confirmed. • You can cancel the changes by changing the parameter number or touching the menu key or the return key (7) to switch the screen without touching the OK key.
<p>5</p>	<p>Exit setting mode</p>	<p>Press the return key or the menu key .</p> <ul style="list-style-type: none"> • The display will return to the setting menu screen.

<When editing directly from the detailed home screen>





- Touch the key or the key to change the value for the sewing pitch for the main sewing section.
- * The parameters which are displayed in the detailed home screen can be changed. If changing a parameter from its initial setting, the screen may be different from the one shown at left.

<When editing directly from the simple home screen>

When you select the sewing pitch icon, the procedure will go directly to step 3.

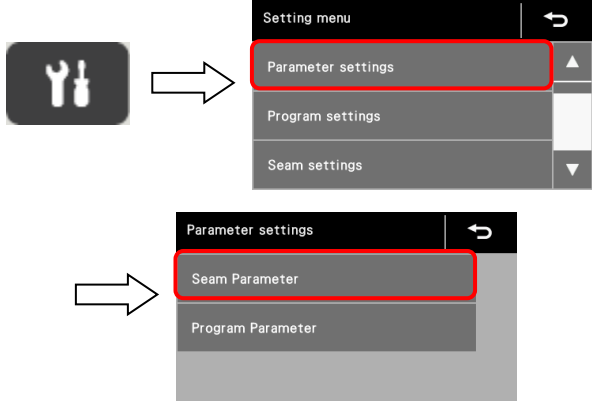
6-2. Changing the presser foot pressure

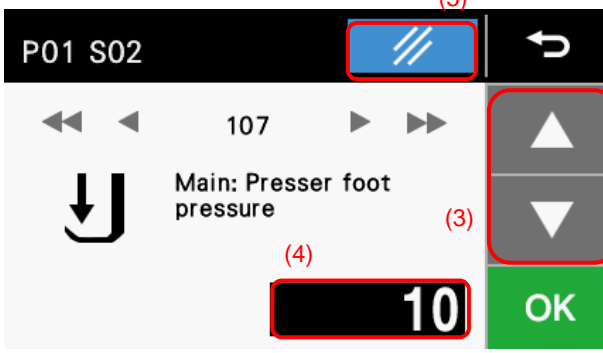
- The larger the number, the larger the presser foot pressure will be.
- The presser foot pressure should be as weak as possible, but strong enough so that the material does not slip.

<p>1</p>	<p>Switch to the seam parameter setting screen</p> 	<p>Press the menu key to switch to the setting menu. Touch [Parameter settings] in the setting menu, and then touch [Seam parameter].</p>  <p>Switch to the seam parameter setting screen.</p>
<p>2</p>	<p>Select the parameter number for the parameter that you would like to change.</p> 	<p>Touch the [◀] or [▶] key (1) to select "Main: Presser foot pressure".</p> <ul style="list-style-type: none"> • When you touch the [◀◀] or [▶▶] key (2), the parameters which have been changed from initial settings will appear in order.
<p>3</p>	<p>Change the setting of the parameter.</p> 	<p>Touch the ▲ key or the ▼ key (3) to change the setting value (4).</p> <ul style="list-style-type: none"> • If no setting value has already been set, the display will blink. <p>You can make the initial setting appear in the display by touching the reset key (5).</p>
<p>4</p>	<p>Apply the changed setting.</p> 	<p>Touch the OK key (6).</p> <ul style="list-style-type: none"> • The setting value (4) will stop blinking and illuminate, and this means that the parameter setting is confirmed. • You can cancel the changes by changing the parameter number or touching the menu key (wrench icon) or the return key (return icon) (7) to switch the screen without touching the OK key.
<p>5</p>	<p>Exit setting mode</p> 	<p>Press the return key (return icon) or the menu key (wrench icon).</p> <ul style="list-style-type: none"> • The display will return to the setting menu screen.

6. USING THE SEWING MACHINE (SEWING OPERATION)

<When editing directly from the detailed home screen>

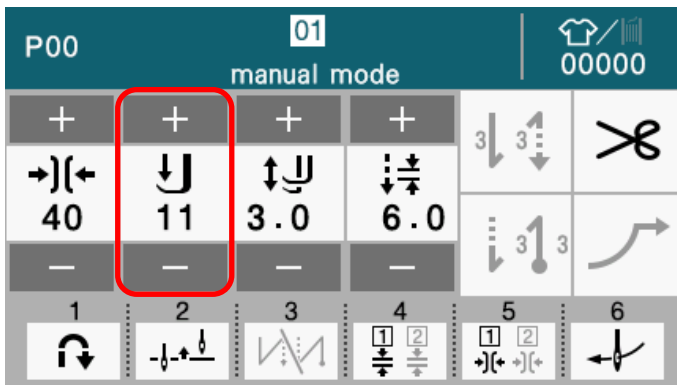





· Touch the **+** key or the **-** key to change the value for the presser foot pressure for the main sewing section.

* The parameters which are displayed in the detailed home screen can be changed. If changing a parameter from its initial setting, the screen may be different from the one shown at left.

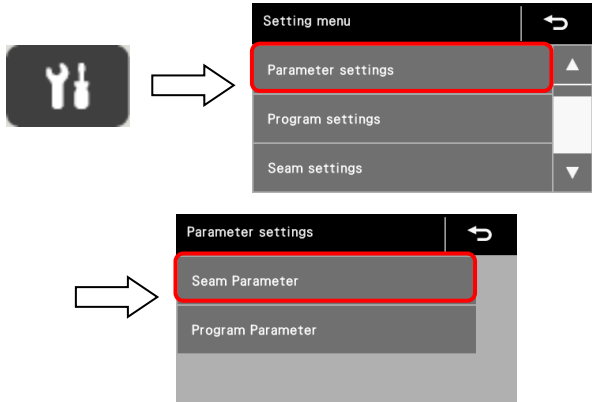
6-3. Changing the walking foot stroke

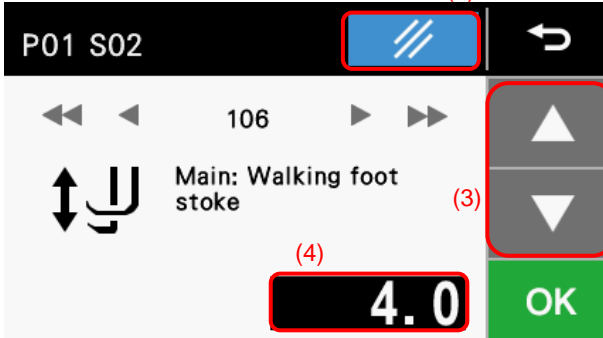
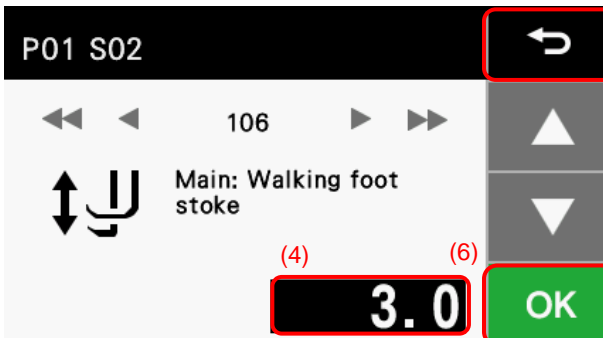
- Adjust the walking foot stroke in accordance with the thickness of the material.

<p>1</p>	<p>Switch to the seam parameter setting screen.</p> 	<p>Press the menu key to switch to the setting menu. Touch [Parameter settings] in the setting menu, and then touch [Seam parameter].</p>  <p>Switch to the seam parameter setting screen.</p>
<p>2</p>	<p>Select the parameter number for the parameter that you would like to change.</p> 	<p>Touch the [◀] or [▶] key (1) to select "Main: Walking foot stroke".</p> <ul style="list-style-type: none"> When you touch the [◀◀] or [▶▶] key (2), the parameters which have been changed from initial settings will appear in order.
<p>3</p>	<p>Change the setting of the parameter.</p> 	<p>Touch the ▲ key or the ▼ key (3) to change the setting value (4).</p> <ul style="list-style-type: none"> If no setting value has already been set, the display will blink. <p>You can make the initial setting appear in the display by touching the reset key (5).</p>
<p>4</p>	<p>Apply the changed setting.</p> 	<p>Touch the OK key (6).</p> <ul style="list-style-type: none"> The setting value (4) will stop blinking and illuminate, and this means that the parameter setting is confirmed. You can cancel the changes by changing the parameter number or touching the menu key or the return key (7) to switch the screen without touching the OK key.
<p>5</p>	<p>Exit setting mode</p> 	<p>Press the return key or the menu key.</p> <ul style="list-style-type: none"> The display will return to the setting menu screen.

6. USING THE SEWING MACHINE (SEWING OPERATION)

<When editing directly from the detailed home screen>

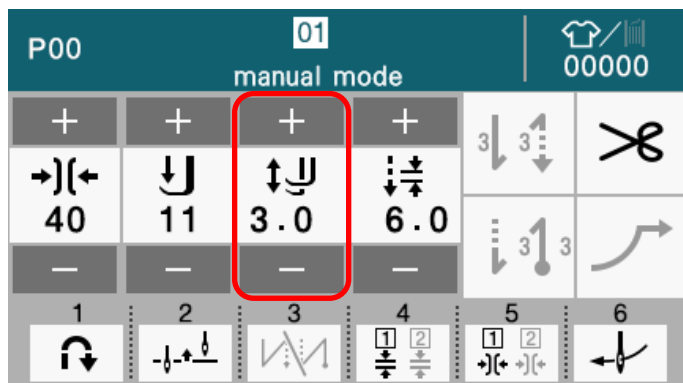



- Touch the **+** key or the **-** key to change the value for the walking foot stroke for the main sewing section.





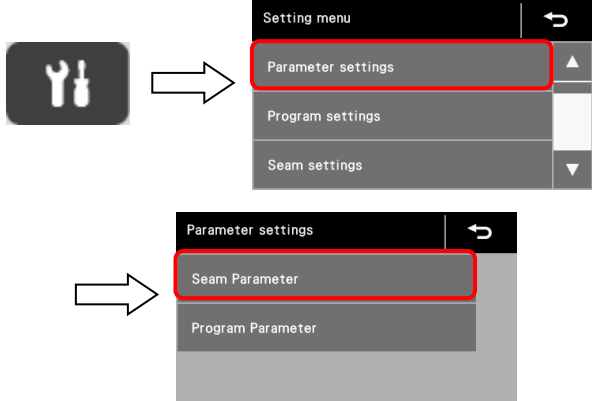

- * The parameters which are displayed in the detailed home screen can be changed. If changing a parameter from its initial setting, the screen may be different from the one shown at left.

6-4. Changing the sewing speed

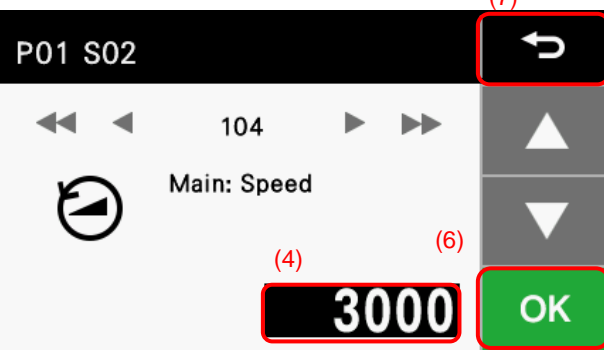
- The larger the number, the faster the sewing speed will be.
- Adjust after checking the finished stitches.

<p>1</p>	<p>Switch to the seam parameter setting screen.</p> 	<p>Press the menu key to switch to the setting menu. Touch [Parameter settings] in the setting menu, and then touch [Seam parameters].</p>  <p>Switch to the seam parameter setting screen.</p>
<p>2</p>	<p>Select the parameter number for the parameter that you would like to change.</p> 	<p>Touch the [◀] or [▶] key (1) to select "Main: Sewing speed"</p> <ul style="list-style-type: none"> • When you touch the [◀◀] or [▶▶] key (2), the parameters which have been changed from initial settings will appear in order.
<p>3</p>	<p>Change the setting of the parameter.</p> 	<p>Touch the ▲ key or the ▼ key (3) to change the setting value (4).</p> <ul style="list-style-type: none"> • If no setting value has already been set, the display will blink. <p>You can make the initial setting appear in the display by touching the reset key (5).</p>

6. USING THE SEWING MACHINE (SEWING OPERATION)

<p>4</p>	<p>Apply the changed setting.</p> 	<p>Touch the OK key  (6).</p> <ul style="list-style-type: none"> • The setting value (4) will stop blinking and illuminate, and this means that the parameter setting is confirmed. • You can cancel the changes by changing the parameter number or touching the menu key  or the return key  (7) to switch the screen without touching the OK key.
<p>5</p>	<p>Exit setting mode</p> 	<p>Press the return key  or the menu key .</p> <ul style="list-style-type: none"> • The display will return to the setting menu screen.

<When editing directly from the simple home screen>

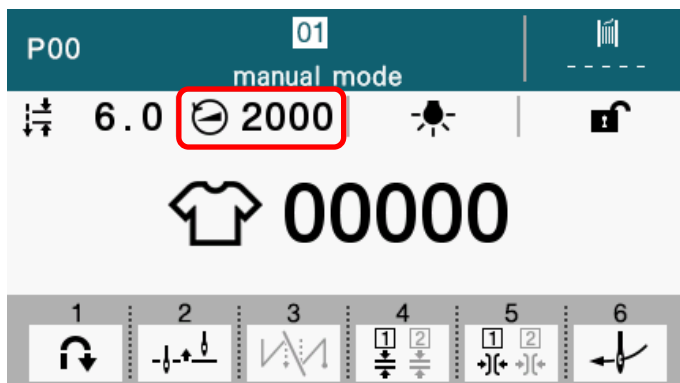

When you select the sewing speed icon, the procedure will go directly to step 3.

- * The speed can also be displayed by changing the parameters which are displayed in the detailed home screen.

<Sewing speed limits>

The sewing speed is limited by the sewing pitch and the walking foot stroke, and so it may not be possible to reach the speed which is displayed on the panel. Refer to the following table on page 2 for the speed limits.

6-5. Sewing error detection function (For -101 (sewing error detection) specifications only)

Sewing machines with sewing error detection specifications include a function for detecting sewing errors during sewing. If the upper thread comes out from the main tension discs or if skipped stitches or thread breakages occur during sewing, the sewing machine stops and the LED illuminates red.

6-5-1. Function settings

You can select the types of sewing errors to be detected.

The function can detect the following three types of errors.

Upper thread coming out from the main tension discs: Detects when the upper thread comes out from the main tension discs during sewing. (*1, *2)

Skipped stitches: Detects when skipped stitches occur because the upper thread has not entangled with the lower thread.

Thread breakages: Detects when the upper thread breaks during sewing.







*1 If the upper thread comes out from the thread tension, initial values cannot be used. In order to enable this function, change the setting mode to administrator setting mode and turn on the function in the screen below.

*2 Detection of the upper thread coming out from the main tension discs is possible under the following conditions.

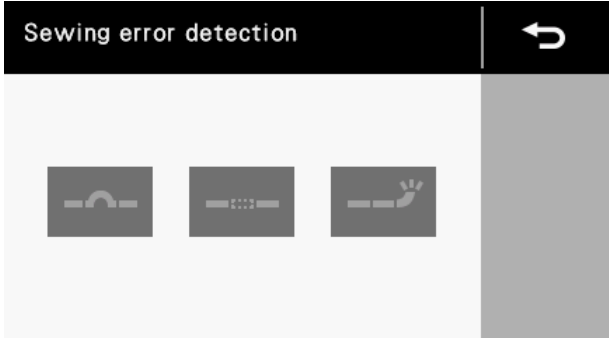
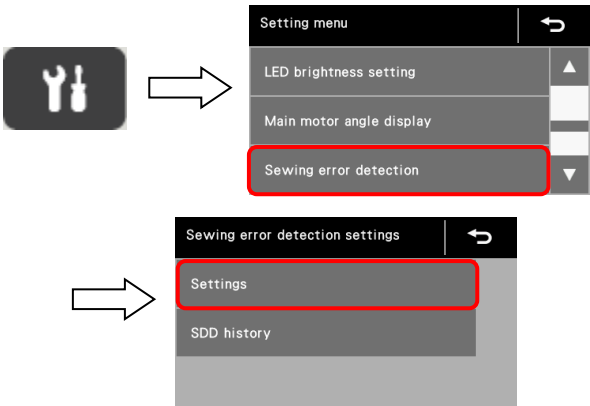
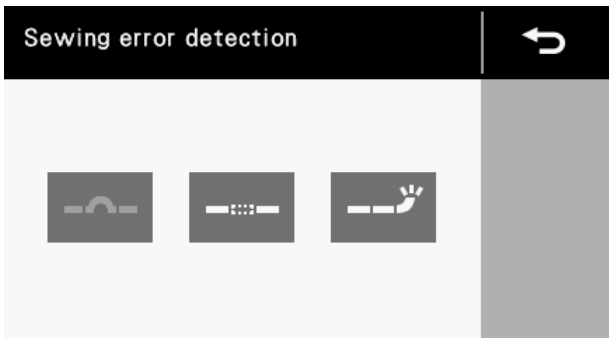
- Uniform main tension during sewing

Example: not using main tension correction in cross over seam assist mode and main tension settings for seam parameters are all the same value (check parameter numbers 012, 013, 062, 063, 109, 110)

- Operation is carried out at constant speed during sewing.

<p>1</p>	<p>Switch to the sewing error detection function setting screen.</p> 	<p>Touch the menu key to switch to the setting menu. Touch [Sewing error detection] in the setting menu, and then touch [Settings].</p>  <p>The screen will switch to the sewing error detection function setting screen.</p>
<p>2</p>	<p>Change the setting for each function to ON or OFF.</p> 	<p>Touch the icons to switch the functions between ON and OFF.</p> <p> : Upper thread coming out from the main tension discs</p> <p> : Skipped stitches</p> <p> : Thread breakages</p>
<p>3</p>	<p>Exit setting mode</p> 	<p>Press the return key  or the menu key .</p> <ul style="list-style-type: none"> • The display will return to the setting menu screen.

6. USING THE SEWING MACHINE (SEWING OPERATION)

6-5-2. When a sewing error is detected

When a sewing error is detected, a warning is displayed on the panel screen and the LED illuminates red. The sewing machine will not operate at this time, even if the pedal is depressed. (*1)

*1 When a sewing error is detected, sewing can be continued without stopping the sewing machine. The administrator can change the setting to whether the LED illuminates or not.





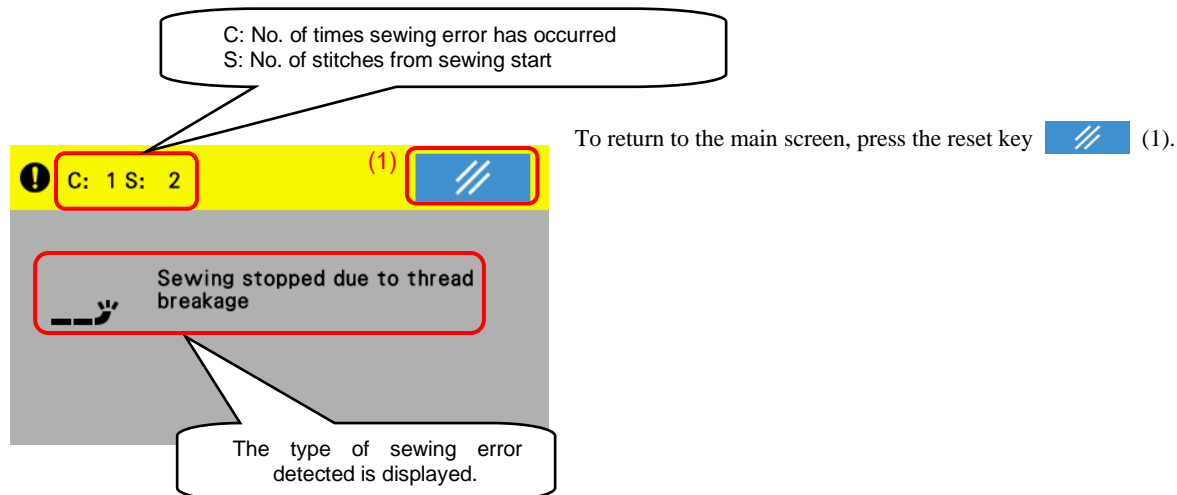

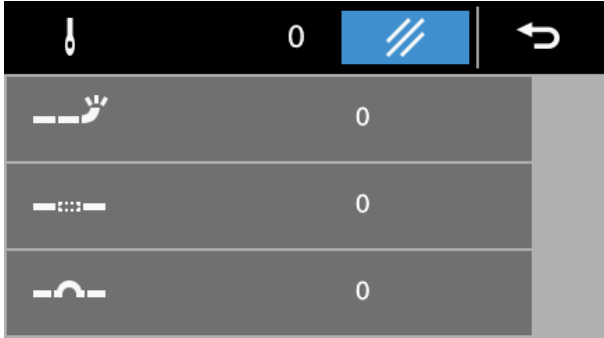
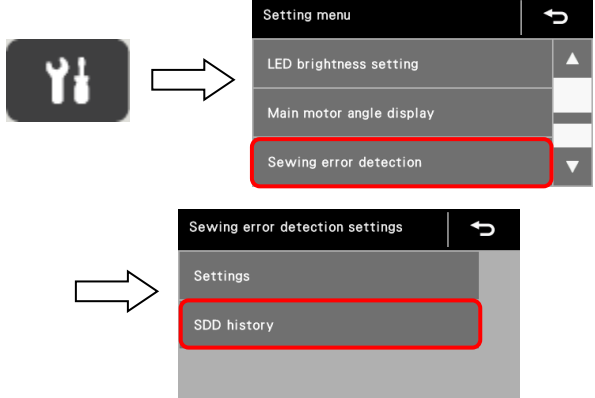
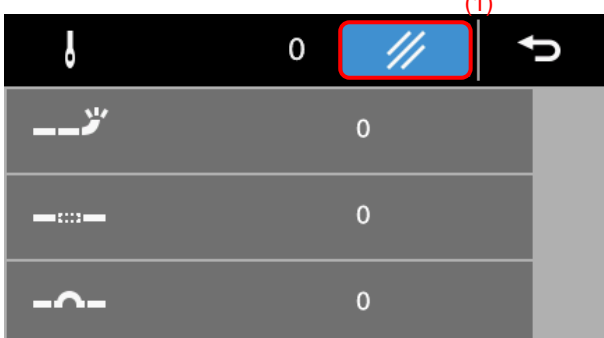

<Description of screen>

When a sewing error is detected, the following screen is displayed.



6-5-3. Resetting the sewing error counter

You can check the sewing error history and reset the counter.

<p>1</p>	<p>Switch to the sewing error detection history setting screen.</p> 	<p>Touch the menu key to switch to the setting menu. Touch [Sewing error detection] in the setting menu, and then touch [SDD history].</p>  <p>The screen will switch to the error detection history screen.</p>
<p>2</p>	<p>Touch the reset key to clear the history.</p> 	<p>You can make the initial setting appear in the display by touching the reset key  (1).</p> <ul style="list-style-type: none"> You can cancel the reset by touching the menu key  or the return key  (7) to switch the screen without touching the reset key .
<p>3</p>	<p>Exit setting mode</p> 	<p>Press the return key  or the menu key .</p> <ul style="list-style-type: none"> The display will return to the setting menu screen.

6-6. Material thickness correction function

This function detects the thickness of the material during sewing, and makes corrections to the parameters.

The three modes which are used for detecting the material thickness and making the corrections are "Linear", "ON/OFF" and "ON".

- During sewing (while the main shaft motor is operating), the maximum value for the material thickness is recorded at a point near the highest need up stop position.
- Refer to "5-4-4. Program parameter settings" for details on parameters such as the upper limit and lower limit for the correction value.
- Refer to "7-4. Assigning functions to the machine head switches" for details on the parameters which have been assigned to machine head switches.

6-6-1. Descriptions of each mode

<Linear mode>

Recorded thickness of the material

- If the material is thicker than the upper threshold value, maximum correction values are applied to the parameter settings.
- If the material thickness is in between the lower and upper threshold values, corrections are applied in accordance with the material thickness.
- If the material is thinner than the lower threshold value, sewing continues.

<ON/OFF mode>

- If the recorded thickness of the material is thicker than the threshold value, corrections are applied to the parameter settings.
- When the thickness of the material becomes thinner than the threshold value, parameter corrections are turned off.
- In this mode, the maximum correction value and threshold upper limit are not used.

<ON mode>

- If the recorded thickness of the material is thicker than the threshold value, corrections are applied to the parameter settings.
- Parameter corrections are maintained until thread trimming is carried out.
- Once sewing stops after thread trimming is carried out, the parameter corrections are turned off.
- In this mode, the maximum correction value and threshold upper limit are not used.

6-6-2. Material thickness correction function settings

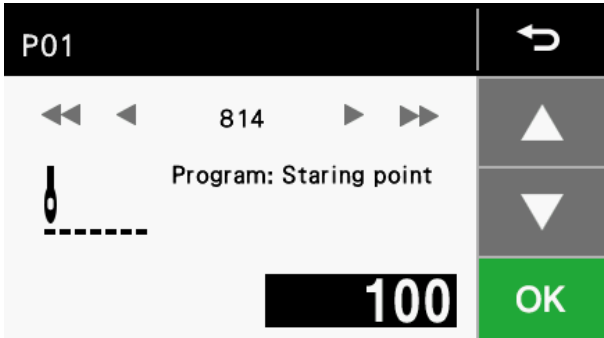
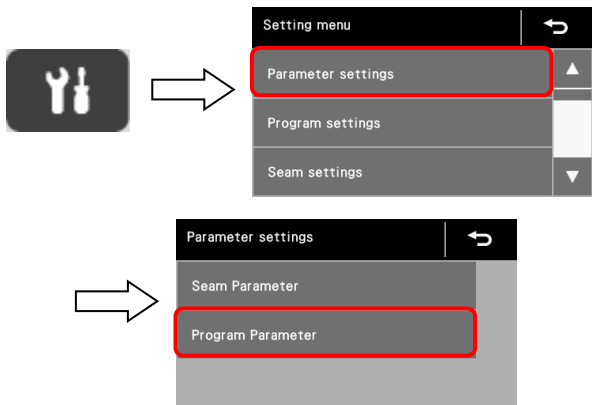
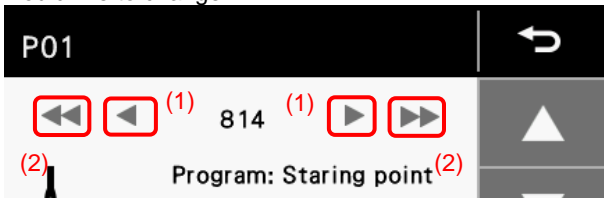
1	<p>Switch to the program parameter setting screen.</p> 	<p>Press the menu key to switch to the setting menu. Touch [Parameter settings] in the setting menu, and then touch [Program parameter].</p> 
2	<p>Select the parameter number for the parameter that you would like to change.</p> 	<p>Switch to the program parameter setting screen. Touch the [◀] or [▶] key (1) to select "Material pressure correction: X-over seam assist mode".</p> <ul style="list-style-type: none"> • When you touch the [◀◀] or [▶▶] key (2), the parameters which have been changed from initial settings will appear in order.

3 Change the "Material pressure correction: X-over seam assist mode" setting.

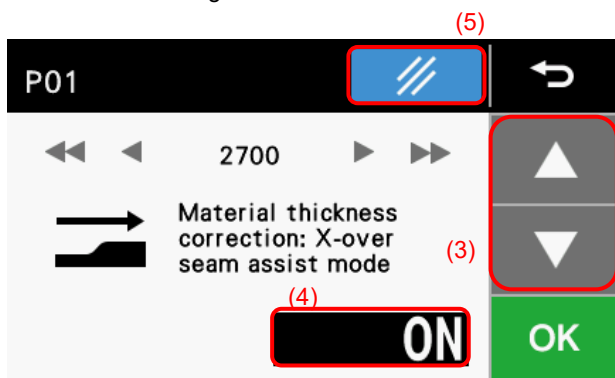

Touch the key or the key (3) to change the setting value (4).

When "Material pressure correction: X-over seam assist mode" is set to "ON", other parameters can then be changed.

- If no setting value has already been set, the display will blink.

You can make the initial setting appear in the display by touching the reset key (5).

4 Change the correction mode of each parameter.

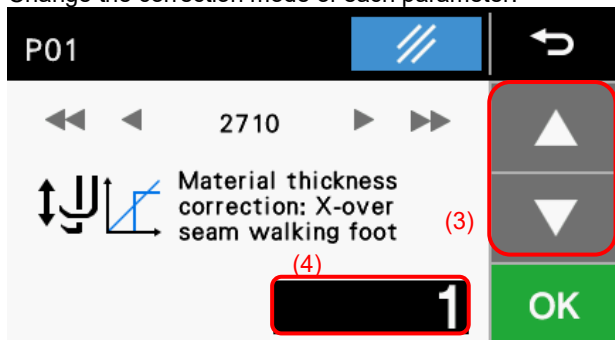

Different correction modes can be selected for each parameter.

Touch the key or the key (3) to change the setting value (4).

Refer to the following table for the modes which can be used for each parameter.

	1: Linear	2: ON/OFF	3: ON
2710: Walking foot stroke	<input type="radio"/>	<input type="radio"/>	<input type="radio"/>
2720: Sewing pitch	<input type="radio"/>	<input type="radio"/>	<input type="radio"/>
2730: Main tension (right: twin needle only)	<input type="radio"/>	<input type="radio"/>	<input type="radio"/>
2740: Main tension (left)	<input type="radio"/>	<input type="radio"/>	<input type="radio"/>
2750: Presser foot pressure	<input type="radio"/>	–	–
2760: Speed	<input type="radio"/>	–	–

5 Change the settings of each parameter.



You can set the upper limits and lower limits for the correction values for each parameter.

* The correction values for each parameter can be changed if the parameter has been set to other than "OFF" in step 4.







Example: "2712: Material thickness correction: X-over seam walking foot stroke threshold minimum limit" can be changed if "2710: Material thickness correction: X-over seam walking foot stroke mode" has been set to "1", "2" or "3".

Touch the key or the key (3) to change the setting value (4).

You can touch the check key (6) to check the details of the current settings on the panel screen. In this case, place the detecting material below the presser foot and lower the presser foot by depressing the pedal and then touch the check key.

Refer to "5-4-4. Program parameter settings" for details on parameters which can be set.



6. USING THE SEWING MACHINE (SEWING OPERATION)

<p>6</p>	<p>Apply the changed setting.</p> 	<p>Touch the OK key  (7).</p> <ul style="list-style-type: none"> • The setting value (4) will stop blinking and illuminate, and this means that the parameter setting is confirmed. • You can cancel the changes by changing the parameter number or touching the menu key  or the return key  (8) to switch the screen without touching the OK key.
<p>7</p>	<p>Exit setting mode </p>	<p>Press the return key  or the menu key .</p> <ul style="list-style-type: none"> • The display will return to the setting menu screen.

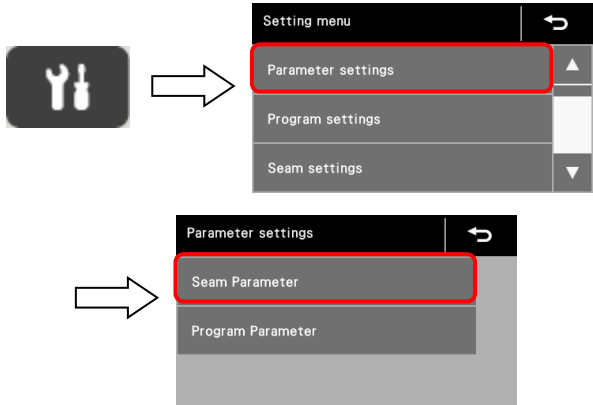

6-7. Sewing start material thickness detection function

- You can set the sewing start material thickness detection function set separately for each seam.
- If the sewing start material thickness is within the upper limit and the lower limit for the material thickness threshold value, normal sewing is possible.

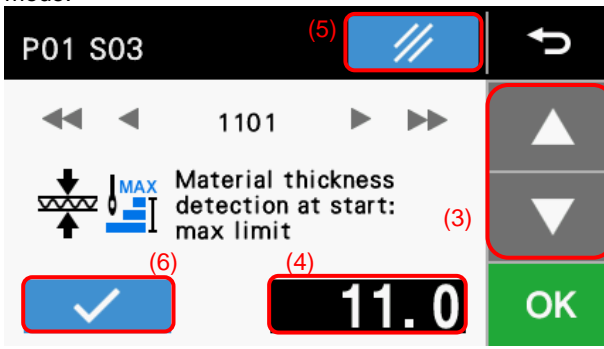
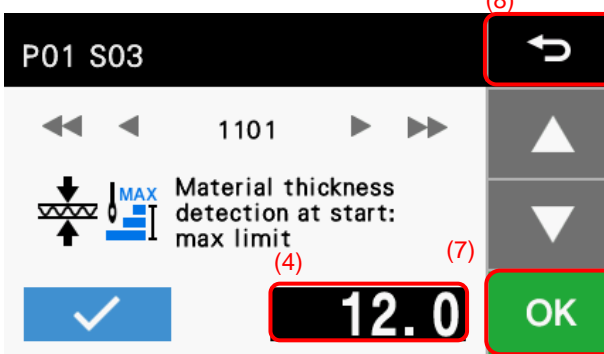
<Function settings>

<p>1</p>	<p>Switch to the seam parameter setting screen.</p> 	<p>Press the menu key to switch to the setting menu. Touch [Parameter settings] in the setting menu, and then touch [Seam parameter].</p>  <p>Switch to the seam parameter setting screen.</p>
<p>2</p>	<p>Select the parameter number for the parameter that you would like to change.</p> 	<p>Touch the [◀] or [▶] key (1) to select "Sewing start material thickness detection: mode".</p> <ul style="list-style-type: none"> • When you touch the [◀◀] or [▶▶] key (2), the parameters which have been changed from initial settings will appear in order.
<p>3</p>	<p>Change the sewing start material thickness detection mode.</p> 	<p>Touch the ▲ key or the ▼ key (3) to change the setting value (4).</p> <p>When "Sewing start material thickness detection: mode" is set to "ON", other parameters can then be changed.</p> <ul style="list-style-type: none"> • If no setting value has already been set, the display will blink. <p>You can make the initial setting appear in the display by touching the reset key (5).</p> <p>You can touch the check key (6) to check the details of the current settings on the panel screen.</p>
<p>4</p>	<p>Change the settings of each parameter.</p> 	<p>Touch the OK key (7).</p> <ul style="list-style-type: none"> • The setting value (4) will stop blinking and illuminate, and this means that the parameter setting is confirmed. • You can cancel the changes by changing the parameter number or touching the menu key or the return key (8) to switch the screen without touching the OK key.

6. USING THE SEWING MACHINE (SEWING OPERATION)

5	Exit setting mode		Press the return key  or the menu key  . • The display will return to the setting menu screen.
----------	-------------------	---	---

<Description of screen>

- If the thickness is below the lower limit or above the upper limit, a warning screen is displayed and pedal operations are disabled.

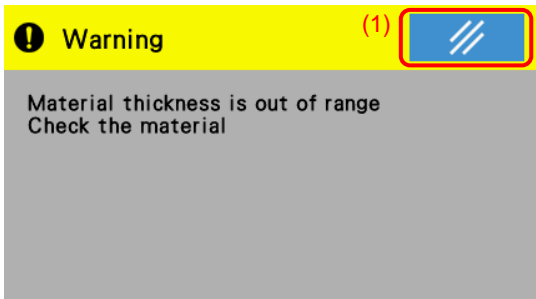

To return to the main screen, press the reset key  (1).

7. USING THE SEWING MACHINE (OPERATION PANEL: ADVANCED OPERATION)

7-1. Adding/deleting/copying seams

You can put together programs, such as the one shown in the illustration at right for pocket sewing, by registering multiple seams.

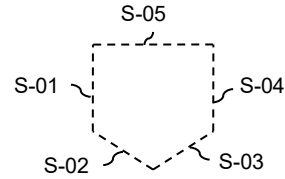



<Switching to seam editing mode>

<p>1</p>	<p>Switch to the setting menu screen.</p> <p>From the detailed home screen Move to the program that you would like to edit.</p>
<p>From the simple home screen Move to the program that you would like to edit.</p>	
<p>2</p>	<p>Switch to the seam settings screen.</p> <p>Press the menu key to switch to the setting menu screen. At the menu screen, select "Edit seam" to switch to the seam editing settings.</p>

7. USING THE SEWING MACHINE (OPERATION PANEL: ADVANCED OPERATION)

<Adding seams>

<p>1</p>	<p>Switch to the add seam screen.</p> 	<p>Select "Add seam" to move to the add seam screen.</p>
<p>2</p>	<p>Add the seam(s).</p> 	<ol style="list-style-type: none"> When a seam number is pressed, a check mark (✓) appears in the check box. When the + key (1) is pressed, the following operation is carried out. If there is no check mark in the check box: A new seam number is added to the end. If there is a check mark in the check box: A new seam number will be added in between the seam numbers which appear with check marks, and the seam numbers coming after this will be increased by "1". <ul style="list-style-type: none"> Touch the ▲ key or the ▼ key (2) to switch to the previous or next page. Once 20 seams have been registered, no more seams can be added. To add another seam, first delete an existing seam.

<Deleting seams>

1



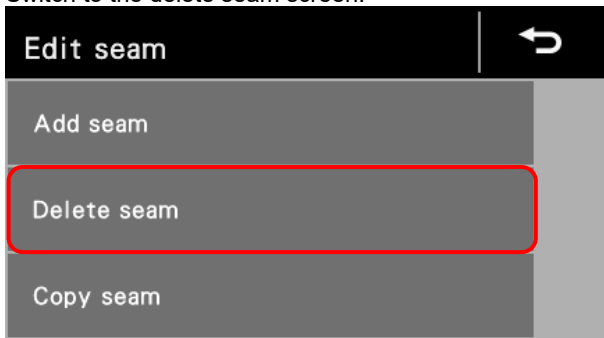

Switch to the delete seam screen.

Select "Delete seam" to move to the delete seam screen.



2

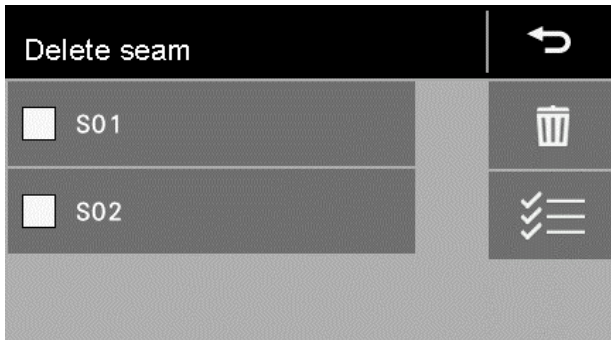
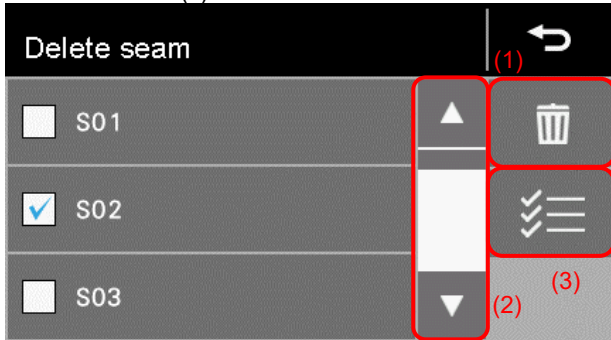

Delete the seam(s).

- Press the check box of the seam which you would like to delete, so that a check mark (✓) appears in that check box.
- Touch the delete key  (1) to delete the seams which have their check marks selected.
- Touch the  key or the  key (2) to switch to the previous or next page.
- Touch the  key (3) to select all of the check mark boxes.



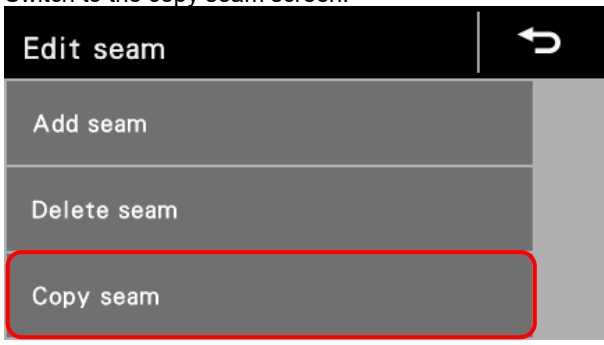
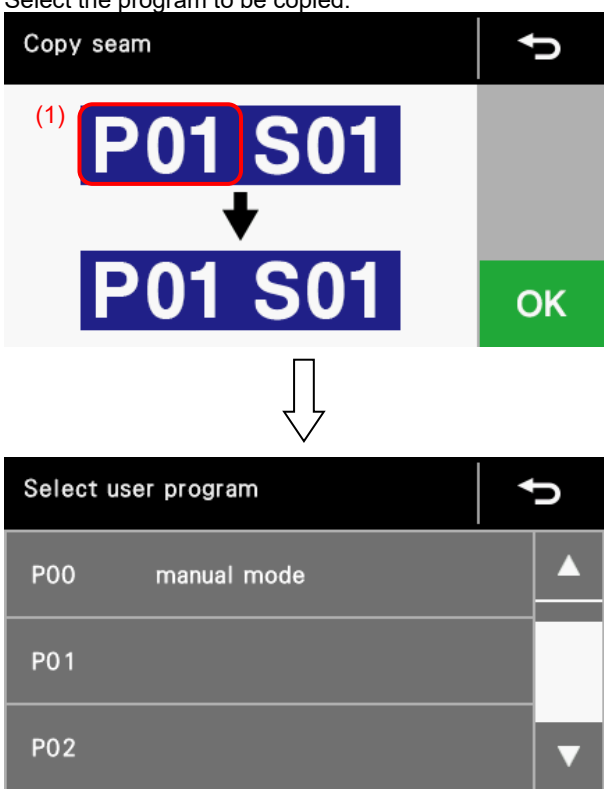

7. USING THE SEWING MACHINE (OPERATION PANEL: ADVANCED OPERATION)

<Copying seams>

<p>1</p>	<p>Switch to the copy seam screen.</p> 	<p>Select "Copy seam" to move to the copy seam screen.</p>
<p>2</p>	<p>Select the program to be copied.</p> 	<p><Selecting the copy source></p> <ul style="list-style-type: none"> · Touch the program number (1) to be copied. · Touch the program number containing the seams to be copied. · Touch the  key or the  key to switch to the previous or next page.

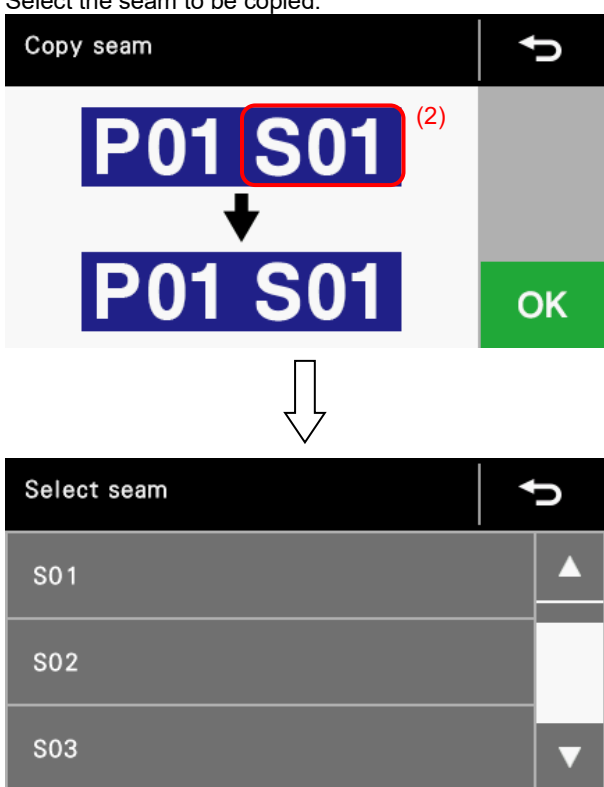
3 Select the seam to be copied.





- Touch the seam number (2) for the seam to be copied.
- Touch the seam number for the seam to be copied.
- Touch the  key or the  key to switch to the previous or next page.

4 Repeat steps 2 and 3 above to select other seams to be copied in the same way.

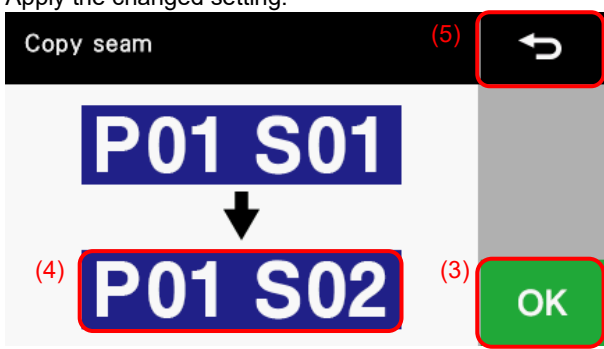
5 Apply the changed setting.





Touch the OK key  (3).

- The seams to be copied (4) will stop blinking and illuminate, and this means that the setting is confirmed.
- You can cancel the changes by changing the parameter number or touching the menu key  or the return key  (5) to switch the screen without touching the OK key.

<Exiting setting mode>

1 Exiting setting mode 





Press the return key  or the menu key .

- The display will return to the setting menu screen.





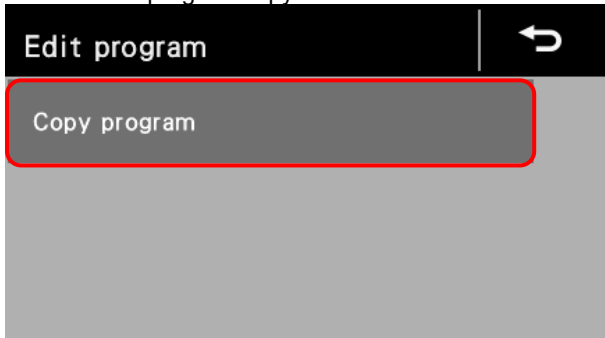
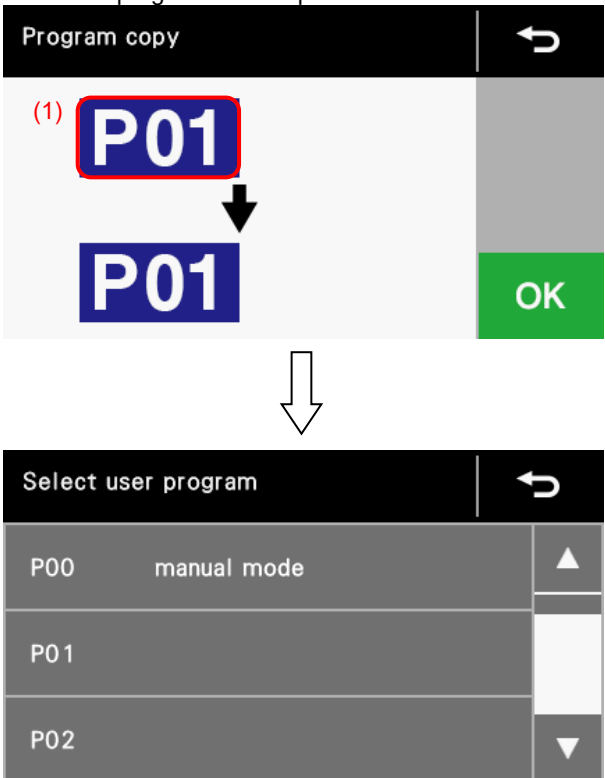

7-2. Copying programs

To create a program with parameters that are almost exactly the same as those of another program, you can copy the original program and change just the parts which need to be changed.

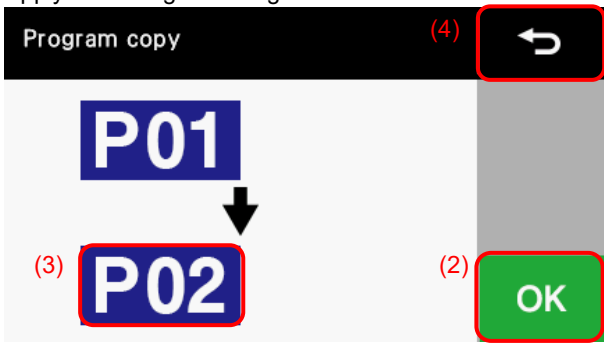
<Switching to program copy mode>

1	<p>Switch to the setting menu screen.</p> 	<p>Press the menu key  to switch to the setting menu screen.</p> <p>At the menu screen, select "Program edit settings" to switch to the program edit settings.</p>
2	<p>Switch to the program copy screen.</p> 	<p>Select "Copy program" to move to the copy program screen.</p>
3	<p>Select the program to be copied.</p> 	<p><Selecting the copy source></p> <ul style="list-style-type: none"> · Touch the program number (1) to be copied. · Touch the program number for the program to be copied. <ul style="list-style-type: none"> · Touch the  key or the  key to switch to the previous or next page.



7. USING THE SEWING MACHINE (OPERATION PANEL: ADVANCED OPERATION)

4	Repeat step 3 above to select other programs to be copied in the same way.	
5	<p>Apply the changed setting.</p> 	<p>Touch the OK key  (2).</p> <ul style="list-style-type: none"> · The seams to be copied (3) will stop blinking and illuminate, and this means that the setting is confirmed. · You can cancel the changes by changing the parameter number or touching the menu key  or the return key  (4) to switch the screen without touching the OK key.
6	<p>Exit setting mode</p> 	<p>Press the return key  or the menu key .</p> <ul style="list-style-type: none"> · The display will return to the setting menu screen.



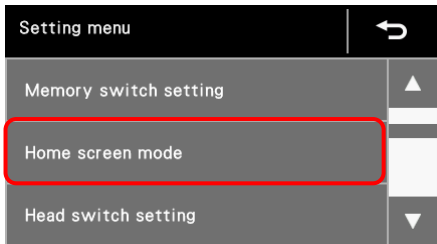

7-3. Home screen settings

- You can select from two different types of home screen display: the detailed home screen or the simple home screen.
 - When a home screen is displayed, you can keep pressing the  key to switch between home screens.
- You can also change the icons which are displayed in the detailed home screen.
- There are two different types of icon.
 - L type: Icons with adjustment functions that include [+] and [-] keys
 - S type: Icons that can switch on and off



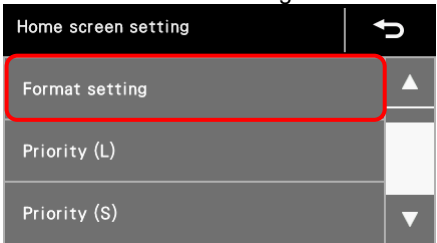
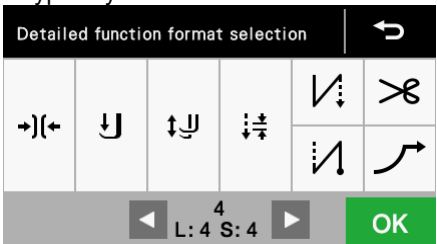

<Switching to home screen mode setting mode>

1	<p>Switch to the home screen setting screen.</p> 	<p>Press the menu key  to switch to the setting menu screen.</p> <p>At the menu screen, select "Home screen setting" to switch to the home screen mode settings.</p>
----------	--	---

<Format setting>

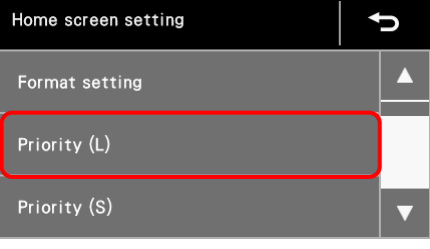
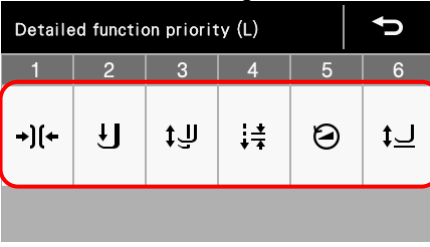
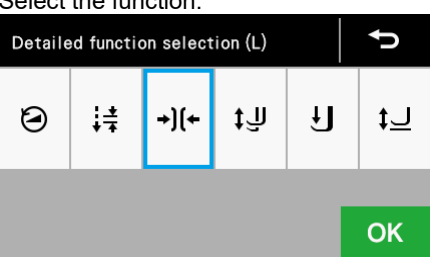



1	<p>Switch to the format setting screen.</p> 	<p>You can change the arrangement of the L-type and S-type icons that are displayed in the detailed home screen.</p> <p>Select "Set format".</p>
2	<p>Select the arrangement for the L-type and S-type keys.</p> 	<p>Touch the [◀] and [▶] keys to change the arrangement of the L-type and S-type keys.</p> <p>Touch the OK key .</p> <ul style="list-style-type: none"> You can cancel the changes by changing the parameter number or touching the menu key  or the return key  to switch the screen without touching the OK key.

<Setting L-type icons>

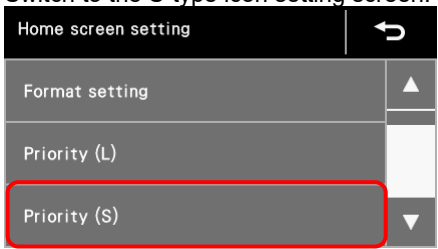
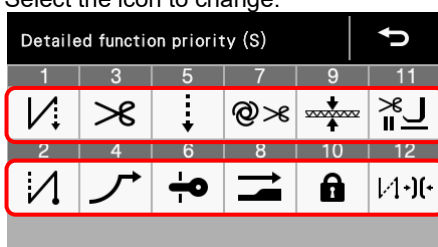
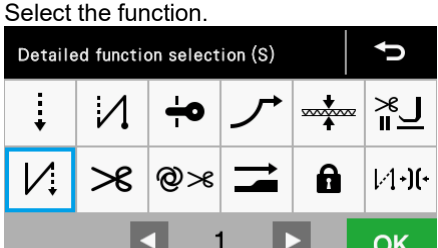

<p>1</p>	<p>Switch to the L-type icon setting screen.</p> 	<p>You can change the settings for the L-type icons.</p> <p>Select "Priority order (L)".</p>
<p>2</p>	<p>Select the icon to change.</p> 	<p>Touch the L-type icon to change.</p>
<p>3</p>	<p>Select the function.</p> 	<p>Touch the icon to be changed, and then touch the OK key .</p> <p>Functions that can be set (from the left)</p> <ol style="list-style-type: none"> (1) Sewing speed (2) Sewing pitch (3) Main tension (left-side tension for twin needle specifications) (4) Main tension (right side) * For twin-needle specifications only (5) Walking foot stroke (6) Presser foot pressure (7) Presser foot height <p>· You can cancel the changes by changing the parameter number or touching the menu key  or the return key  to switch the screen without touching the OK key.</p>
<p>4</p>	<p>Repeat steps 2 to 3 above to record the settings for other icons to be changed in the same way.</p>	

7. USING THE SEWING MACHINE (OPERATION PANEL: ADVANCED OPERATION)

<Setting S-type icons>

<p>1</p>	<p>Switch to the S-type icon setting screen.</p> 	<p>You can change the settings for the S-type icons.</p> <p>Select "Priority order (S)".</p>
<p>2</p>	<p>Select the icon to change.</p> 	<p>Touch the S-type icon to change.</p>
<p>3</p>	<p>Select the function.</p> 	<p>Touch the icon to be changed, and then touch the OK key .</p> <p>Functions that can be set (left side, from top to bottom)</p> <ol style="list-style-type: none"> (1) Main sewing direction (2) Start backtacking (3) End backtacking (4) Thread trimming (5) Thread holder (6) Automatic fixed stitch sewing (7) Slow start (8) X-over seam assist (9) Sewing start material thickness detection (10) Screen lock (11) Automatic presser foot lifting (12) Backtack sewing tension <p>· You can cancel the changes by changing the parameter number or touching the menu key  or the return key  to switch the screen without touching the OK key.</p>
<p>4</p>	<p>Repeat steps 2 to 3 above to record the settings for other icons to be changed in the same way.</p>	

<Exiting setting mode>

<p>1</p>	<p>Exit setting mode</p> 	<p>Press the return key  or the menu key .</p> <p>The display will return to the setting menu screen.</p>
-----------------	--	---

7-4. Assigning functions to the machine head switches

Different operations can be assigned to the 6 function button (1) to (6), the hand switch (7), the jog dial (8) and the F key (9).

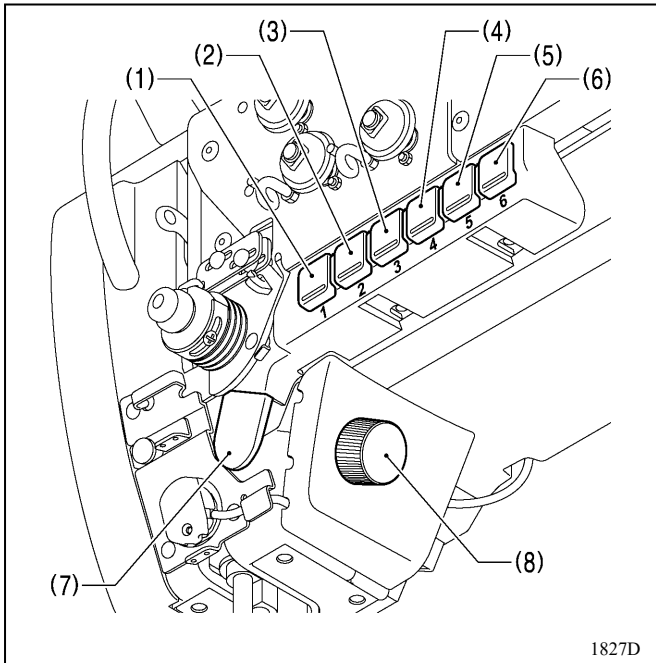

Machine head switch	Menu	No.	setting values
6 function buttons	6 function button setting 1	(1)	10: Reverse
	6 function button setting 2	(2)	9: Single correction sewing
	6 function button setting 3	(3)	27: Start and end backtack cancel
	6 function button setting 4	(4)	12: 2nd pitch switching
	6 function button setting 5	(5)	14: 2nd tension switching
	6 function button setting 6	(6)	33: Needle threading
Hand switch	Hand switch setting	(7)	10: Reverse
Jog dial button		(8)	34: Needle drop alignment
F key		(9)	Set seam parameters





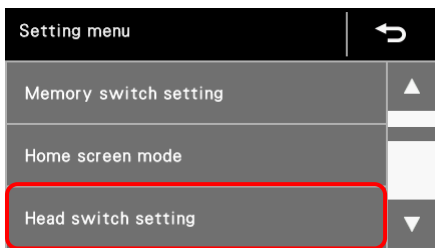

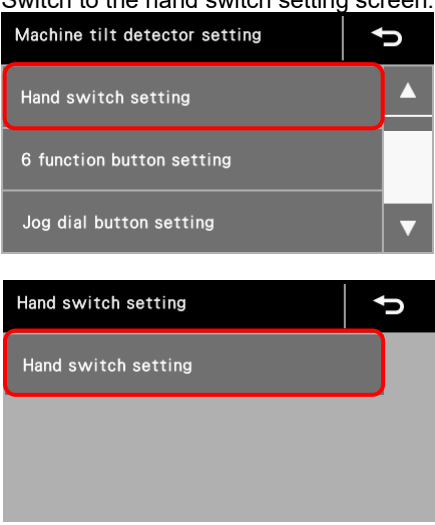
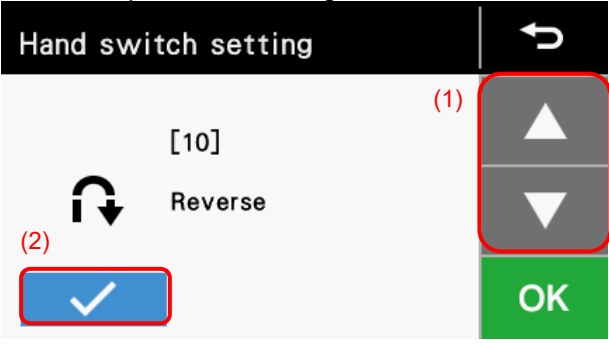

<Switching to machine head switch setting mode>

1 Switch to the machine head switch setting screen.



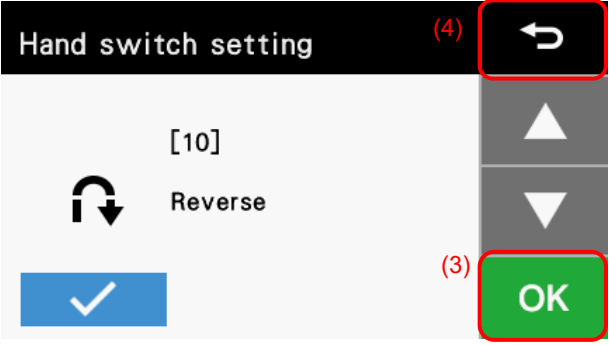





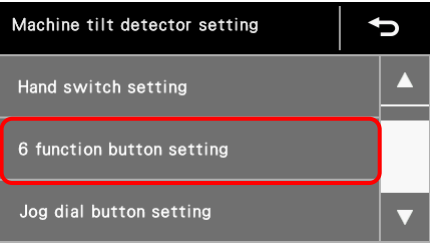
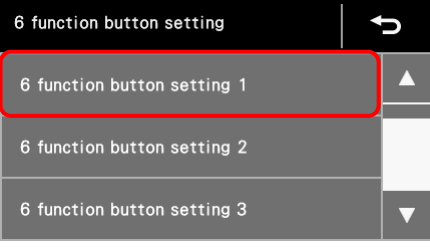
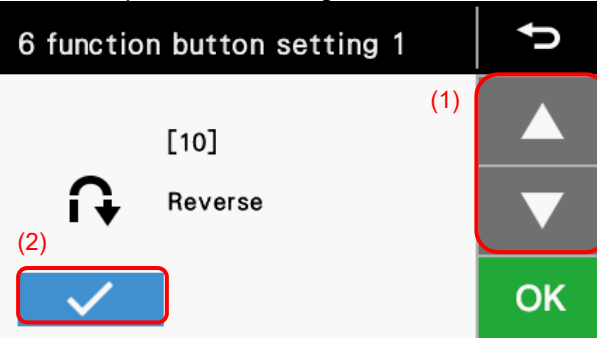

Press the menu key  to switch to the setting menu screen.
At the menu screen, select "Head switch setting" to switch to the machine head switch settings.

<Hand switch setting>

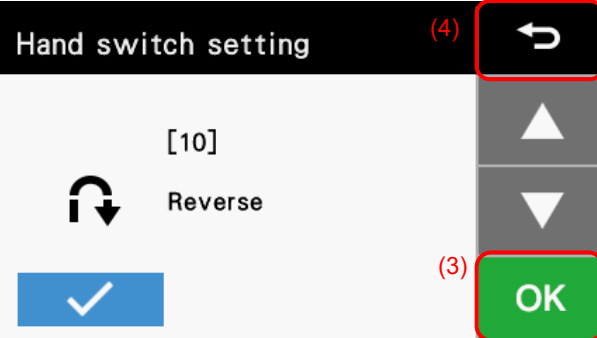





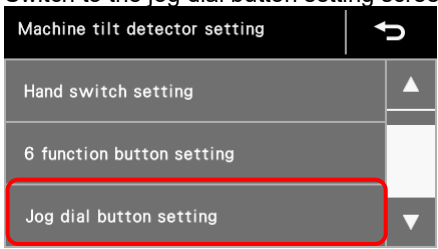
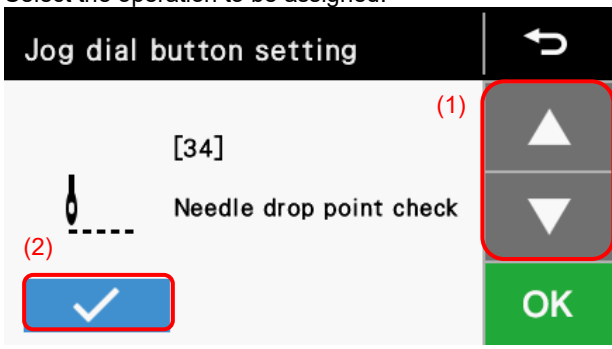

<p>1</p>	<p>Switch to the hand switch setting screen.</p> 	<p>You can change the settings for the hand switch.</p> <p>Select "Hand switch setting" and then select "Hand switch setting".</p>
<p>2</p>	<p>Select the operation to be assigned.</p> 	<p>Touch the  key or the  key (1) to change the assigned operation.</p> <p>You can touch the check key  (2) to check the detailed explanation of the operation which is currently selected.</p>
<p>3</p>	<p>Apply the changed setting.</p> 	<p>Touch the OK key  (3).</p> <ul style="list-style-type: none"> You can cancel the changes by changing the parameter number or touching the menu key  or the return key  (4) to switch the screen without touching the OK key.

<6 function button setting>



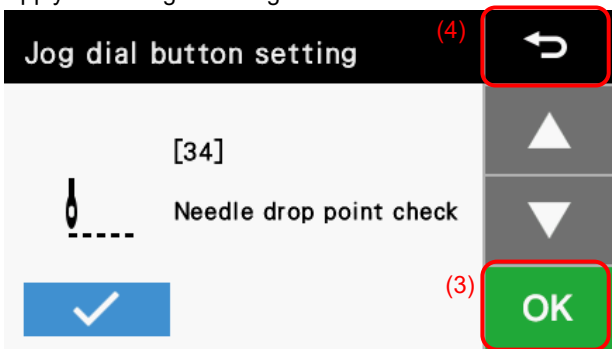



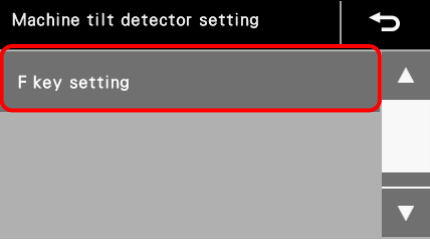
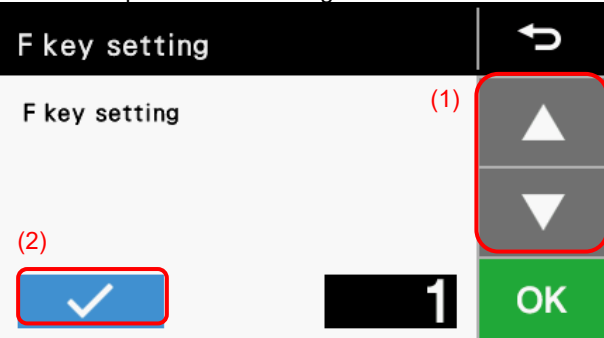

<p>1</p>	<p>Switch to the 6 function button setting screen.</p>  	<p>You can change the settings for each button of the 6 function button.</p> <p>Select "6 function button setting" and then select the setting of 6 function button number that you wish to change.</p>
<p>2</p>	<p>Select the operation to be assigned.</p> 	<p>Touch the  key or the  key (1) to change the assigned operation.</p> <p>You can touch the check key  (2) to check the detailed explanation of the operation which is currently selected.</p>
<p>3</p>	<p>Apply the changed setting.</p> 	<p>Touch the OK key  (3).</p> <ul style="list-style-type: none"> You can cancel the changes by changing the parameter number or touching the menu key  or the return key  (4) to switch the screen without touching the OK key.

7. USING THE SEWING MACHINE (OPERATION PANEL: ADVANCED OPERATION)

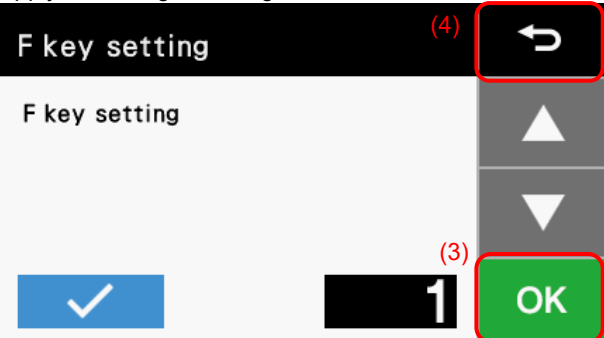

<Jog dial button setting>

<p>1</p>	<p>Switch to the jog dial button setting screen.</p> 	<p>You can change the setting for the jog dial button.</p> <p>Select "Jog dial button setting".</p>
<p>2</p>	<p>Select the operation to be assigned.</p> 	<p>Touch the  key or the  key (1) to change the assigned operation.</p> <p>You can touch the check key  (2) to check the detailed explanation of the operation which is currently selected.</p>
<p>3</p>	<p>Apply the changed setting.</p> 	<p>Touch the OK key  (3).</p> <ul style="list-style-type: none"> You can cancel the changes by changing the parameter number or touching the menu key  or the return key  (4) to switch the screen without touching the OK key.

<F key setting>

1	<p>Switch to the F key screen setting screen.</p> 	<p>You can change the setting for when the F key on the panel is pressed.</p> <p>Select "F key setting".</p>
2	<p>Select the operation to be assigned.</p> 	<p>Touch the  key or the  key (1) to change the assigned operation.</p> <p>You can touch the check key  (2) to check the function which has been assigned to the F key.</p>
3	<p>Apply the changed setting.</p> 	<p>Touch the OK key  (3).</p> <ul style="list-style-type: none"> You can cancel the changes by changing the parameter number or touching the menu key  or the return key  (4) to switch the screen without touching the OK key.

<Exiting setting mode>

1	<p>Exit setting mode</p> 	<p>Press the return key  or the menu key .</p> <ul style="list-style-type: none"> The display will return to the setting menu screen.
----------	--	--



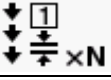
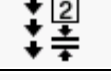
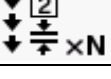





List of machine head switches

Function No.	Icon	Setting item	Description	Hand switch	6 func button	Jog
OFF		No function	Switch disabled	–	–	–
1		One stitch correction sewing	Stops after sewing a single stitch	○	○	–
2		Continuous correction sewing	Sewing continues while the switch is being pressed	○	○	–
3		One stitch correction sewing (2nd pitch)	Stops after sewing a single stitch at 2nd pitch	○	○	–
4		Continuous correction sewing (2nd pitch)	Sewing continues at 2nd pitch while the switch is being pressed	○	○	–

7. USING THE SEWING MACHINE (OPERATION PANEL: ADVANCED OPERATION)

Function No.	Icon	Setting item	Description	Hand switch	6 func button	Jog
5		Reverse one stitch correction sewing	Stops after sewing a single reverse stitch	○	○	–
6		Reverse continuous correction sewing	Reverse sewing continues while the switch is being pressed	○	○	–
7		Reverse one stitch correction sewing (2nd pitch)	Reverse sewing continues at 2nd pitch	○	○	–
8		Reverse continuous correction sewing (2nd pitch)	Reverse sewing continues 2nd pitch while the switch is being pressed, and then stops	○	○	–
9		Half stitch correction sewing	Stops after sewing half stitches	○	○	○
10		Reverse	Feed moves in reverse while the switch is being pressed	○	○	–
11		2nd pitch	Sewing continues at 2nd pitch while the switch is being pressed	–	○	–
12		2nd pitch switch	Switches between normal and 2nd pitch each time the switch is pressed	–	○	–
13		2nd tension	Sewing continues at 2nd tension while the switch is being pressed	–	○	–
14		2nd tension switch	Switches between normal and 2nd tension each time the switch is pressed	–	○	–
15		2nd walking foot stroke	Sewing continues at 2nd walking foot stroke while the switch is being pressed	–	○	–
16		2nd walking foot stroke switch	Switches between normal and 2nd walking foot stroke each time the switch is pressed	–	○	–
17		Manual x-over seam	X-over seam sewing mode is enabled while the switch is being pressed	–	○	–
18		Manual x-over seam switch	X-over seam sewing mode switches on and off each time the switch is pressed	–	○	–
23		LED lighting	The LEDs turn on and off each time the switch is pressed.	–	○	–
24		Production counter count up	The production counter increases by 1 each time the switch is pressed while sewing is stopped.	–	○	–
25		Production counter reset	Production counter reset The lower thread counter does not change	–	○	–
26		End backtack cancel	The next end backtack is canceled and end backtacking is not carried out even when the treadle is depressed backward. (Once only)	–	○	–
27		Start and end backtack cancel	Start and end backtacking can be canceled. (Once only)	–	○	–
28		Pause before reverse in backtack	Backtack matching function ON/OFF When ON, sewing pauses when the backtack direction changes	–	○	–
29		Go to next seam	Sewing moves to the next seam	–	○	–
30		Go to previous seam	Sewing moves to the previous seam	–	○	–

7. USING THE SEWING MACHINE (OPERATION PANEL: ADVANCED OPERATION)

Function No.	Icon	Setting item	Description	Hand switch	6 func button	Jog
31		Go to next program	Sewing moves to the next program each time the switch is pressed.	-	○	-
32		Go to previous program	Sewing moves to the previous program each time the switch is pressed.	-	○	-
33		Threading	Threading mode	-	○	-
34		Needle drop point check	Needle drop alignment (Needle drops at start position so that needle drop position does not shift) The purpose is to move at an accurate angle over the material. The angle is specified by P parameter No. 814.	○	○	○
35		Needle up	Automatic needle lifting	○	○	○
36		Amount of rotation of jog dial	Switches the ratio between the jog dial rotation amount and the main shaft rotation amount each time the switch is pressed.	○	○	○
38		Disable forward pedal operation	While ON, depressing the treadle forward is disabled.	-	○	-
39		Disable jog dial	While ON, the jog dial is disabled.	-	○	-
40		Bobbin change mode	Disabling treadle operation after needle lifting (For replacing the bobbin)	-	○	-

◇ F key shortcut

The shortcut function is only available when the home screen is being displayed.

No	Object
OFF	None
1	Set seam parameters
2	Set program parameters
3	Copy programs
4	Add seams
5	Delete seams
6	Copy seams
7	Setting operator memory switches

7-5. Changing the memory switch settings (Standard)

- The settings of the memory switches are valid for all programs.

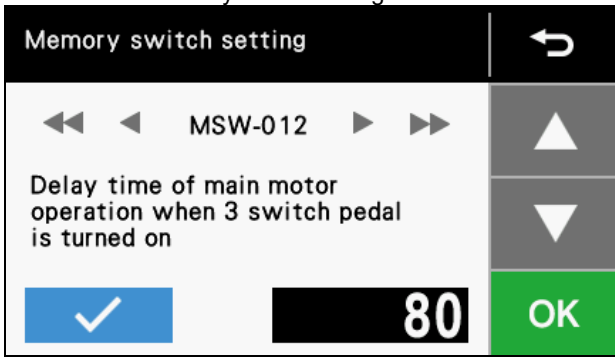
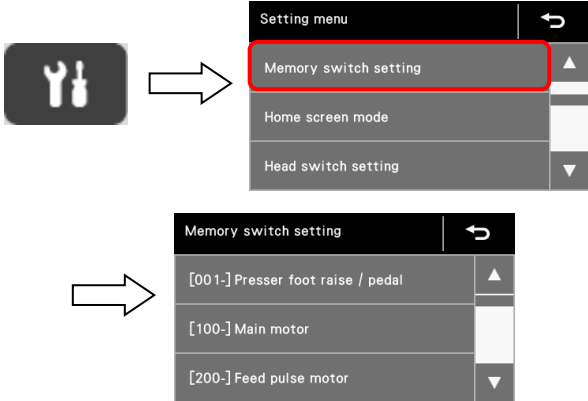
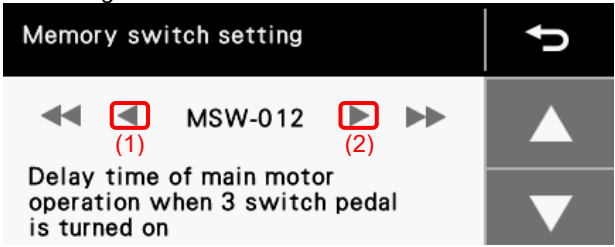
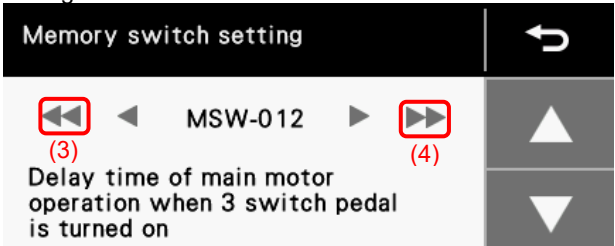
<p>1</p>	<p>Switch to the memory switch setting screen.</p> 	<p>Press the menu key to switch to the setting menu screen. Touch [Memory switch setting] in the setting menu.</p>  <ul style="list-style-type: none"> The display will switch to the memory switch setting screen.
<p>2</p>	<p>Select the memory switch that you would like to change the setting.</p>  <p>When you would like to display only the numbers of memory switches that have been changed from default settings.</p> 	<p>Touch the ◀ key (1) or the ▶ key (2) to select the memory switch number.</p> <p>Touch the ◀◀ key (3) or the ▶▶ key (4).</p> <ul style="list-style-type: none"> The numbers of memory switches that have been changed from default settings will appear in order.

3

Change the memory switch settings.

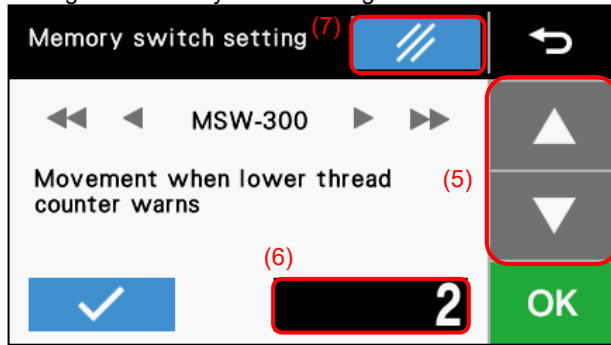

Touch the key or the key (5) to change the setting value (6).

- If no setting value has already been set, the display will blink.
- You can make the default setting appear in the display by touching the reset key (7).

When checking detailed explanations of memory switches

You can touch the check key (8) to check the detailed explanation of the memory switch which is currently selected.

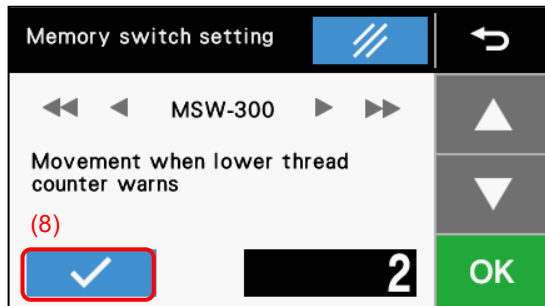

4

Apply the changed setting.

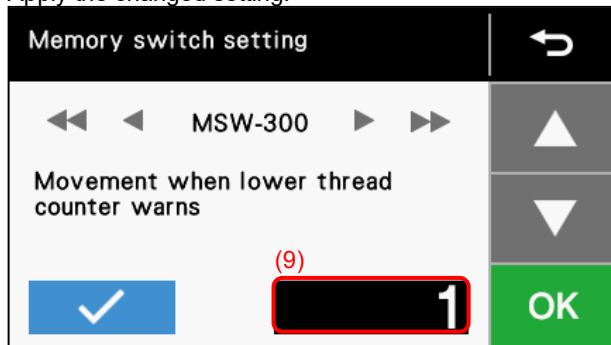

Touch the OK key .

- The setting value (9) will stop blinking and illuminate, and this means that the parameter setting is confirmed.
- If you change the memory switch number or touch the menu key or the return key to switch the screen without touching the OK key, you can cancel the changes.

5

Repeat steps 2 to 4 above to set each memory switch.

6

Exit setting mode



Press the return key or the menu key .

- The display will return to the setting menu screen.

7. USING THE SEWING MACHINE (OPERATION PANEL: ADVANCED OPERATION)

7-6. List of memory switch settings

Presser foot lifter and treadle settings (001 -)

No.	Setting range	Initial value	Step	Setting units	Setting details
012	0-500	80	10	msec	Delay time for motor to start when start switch of 3-step pedal turns on.
015	ON/OFF	ON	1	-	Presser foot raising operation from thread trimming pedal after thread is trimmed during standing operation ON: Presser foot can be lifted and lowered OFF: No operation (only possible using presser foot lifter pedal)

Panel operation settings (300 to 399)

No.	Setting range	Initial value	Step	Setting units	Setting details
300	1,2	1	1	1	Movement when lower thread counter warning. 1: Sewing can continue by pressing the F key 2: Lower thread counter can be reset
311	ON/OFF	OFF	1	ON/OFF	Panel auto lock when turn on power OFF: Disabled ON: Enabled

Sewing program settings (400 to 499)

No.	Setting range	Initial value	Step	Setting units	Setting details
400	ON/OFF	OFF	1	-	Stopping while start backtacking is in progress, and speed during start backtacking ON: When the treadle is returned to the neutral position, start backtacking can be stopped before it is finished, and the speed during start backtacking becomes the speed corresponding to the treadle depression amount (low speed - start backtacking speed) OFF: When the treadle is returned to the neutral position, start tying ends, sewing stops and the sewing speed becomes the start tying (constant) speed
401	ON/OFF	ON	1	-	Feed direction when man shaft is stopped immediately after start backtacking is complete OFF: Motor stops after start backtacking is complete * When No. 400 is set to "OFF", operation can continues each time the treadle is depressed slightly ON: After start backtack sewing is complete, the feed moves forward, then the motor stops. 
405	ON/OFF	ON	1	-	If the main tension is increased or decreased, the backtack sewing tension will also change in sync. ON: Synchronized OFF: Not synchronized
406	ON/OFF	ON	1	-	If the main walking foot stroke is increased or decreased, the backtack walking foot stroke will also change in sync. ON: Synchronized OFF: Not synchronized
407	ON/OFF	ON	1	-	If the main pitch is increased or decreased, the backtack sewing pitch will also change in sync. ON: Synchronized OFF: Not synchronized

7-7. Reading and writing data using USB media

⚠ CAUTION

Do not connect anything to the USB ports of the panel and the error detection unit other than the USB media. Otherwise problems with operation may result.

Programs and memory switch setting details can be copied between sewing machines by means of USB media.

1 Switch to data read/write mode.

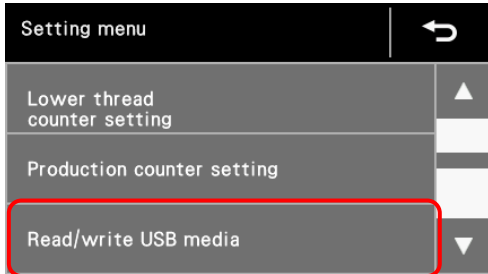



1. First connect the USB media to the sewing machine.
2. At the home screen, press the menu key  to display the scrolling setting menu screen, and then select the "Read/write USB media" menu item. The mode will then change to USB media read/write mode.

- * Some multi card readers may not be recognized.
- * If there is no USB media connected at this time, the message "USB media is not connected or inserted." will be displayed.

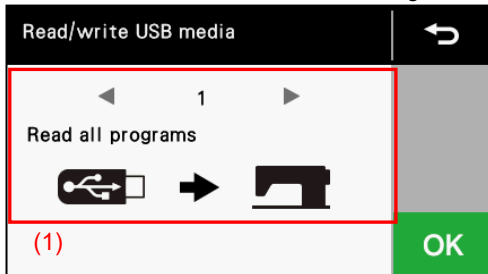
2 Read or write data between the sewing machine and the USB media.



1. The currently-selected read/write item and illustration (1) are displayed, so press the [◀] or [▶] key to change the read/write item.
 2. Touch the OK key  to run the selected read/write item. The read/write in progress screen will be displayed.
- Touch the return key  to return to the setting menu screen.

The read/write items that can be selected are as follows.

Code	Setting item	Read/write direction
1	Read all programs	USB media → (Panel) → Sewing machine
2	Write all programs	USB media ← (Panel) ← Sewing machine
3	Read memory switches	USB media → (Panel) → Sewing machine
4	Write memory switches	USB media ← (Panel) ← Sewing machine
5	Read custom UIs	USB media → (Panel) → Sewing machine
6	Write custom UIs	USB media ← (Panel) ← Sewing machine
7	Read all data	USB media → (Panel) → Sewing machine
8	Write all data	USB media ← (Panel) ← Sewing machine
9	Read QR codes	USB media → (Panel)
10	Read program/seam names	USB media → (Panel) → Sewing machine
11	Write program/seam names	USB media ← (Panel) ← Sewing machine

Creating folders for USB media

Data type	Filename	Folder name
Program	ISMUPG.SEW	¥BROTHER¥ISM¥ISMDN**¥ ("**" is the value of memory switch No. 750.) (Refer to the Service Manual for details on memory switch No. 750.)
Memory switches	ISMMSW.SEW	Same as above
Switch assignment	ISMHSW.SEW	Same as above
Error log	E*****.LDT M*****.LDT	¥BROTHER¥ISM¥ISMLDT¥
Program name / Seam name	ISMNAME.txt	¥BROTHER¥ISM¥ISMDN**¥ ("**" is the value of memory switch No. 750.) (Refer to the Service Manual for details on memory switch No. 750.)

* "QR Code" is a registered trademark of Denso Wave Incorporated.

7-8. Resetting all settings to their defaults

If the sewing machine stops operating normally, the cause may be that an incorrect setting may have been made for the memory data by means of memory switches, for instance. In such cases, it may be possible to restore normal operation by following the steps given below to initialize the stored data.

1 Change to initialization mode.

+
→

4421Q

(While pressing the home key, turn on the power.) The initialization menu screen will be displayed.

[NOTE]
 If the ▲ or ▼ key is touched at this time, you can select the items to be initialized as shown below.
 * For details on initialization items other than "Clear all", refer to the Service Manual.

Panel display item	Initialization item
Clear all	All data in memory is cleared or initialized.
Memory switch initialization	All memory switches which can be initialized are initialized.
Sewing speed initialization	All speed settings are initialized.
Program initialization	All program settings are initialized.
QR code initialization	All QR codes are initialized.

* "QR Code" is a registered trademark of Denso Wave Incorporated.

2 Initialization complete

If you touch an item name in the list, the initialization check screen will be displayed.

- Touch the OK key OK to start the initialization.
- When the screen display returns to the initialization screen, initialization is complete.

8. SEWING MACHINE OPERATION

⚠ CAUTION



Turn off the power switch before carrying out these operations.

The machine may operate if the treadle is depressed by mistake, which could result in injury.



Be sure to wear protective goggles and gloves when handling the lubricating oil and grease so that they do not get into your eyes or onto your skin. Otherwise inflammation can result.

Furthermore, do not drink the lubricating oil or eat the grease under any circumstances. Diarrhea or vomiting may result.

Keep the oil out of the reach of children.



Secure the table so that it will not move when tilting back the machine head.

If the table moves, it may crush your feet or cause other injuries.



Use both hands to hold the machine head when tilting it back or returning it to its original position.

If only one hand is used, the weight of the machine head may cause your hand to slip, and your hand may get caught.

8-1. Resetting the rotary hook protection device

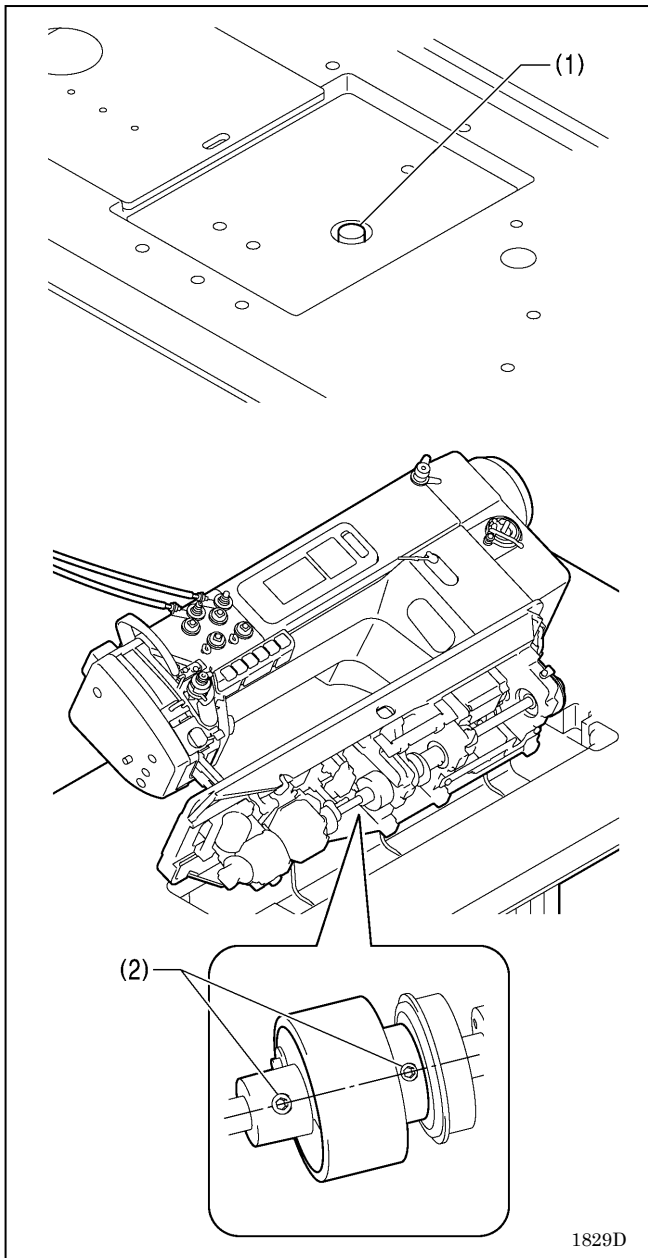

If excessive force is applied to the rotary hook during sewing, the rotary hook protection device will operate. At this time, the phase of the rotary hook will shift from its normal position.

<Reset method>

1. Remove any thread that is tangled in the rotary hook.
 - * Do not use any sharp objects, as they may damage the rotary hook.
2. Turn the pulley so that the hole groove in the rotary hook protection device comes to directly underneath the clutch return button (1).
3. Press the clutch return button (1) so that it goes into the hole groove in the rotary hook protection device, and then firmly turn the pulley.
4. When a click is heard, the reset is complete.

* Tilt back the machine head and check that the four set screws (2) are all in phase.

1829D

8-2. Lifting the work clamp manually

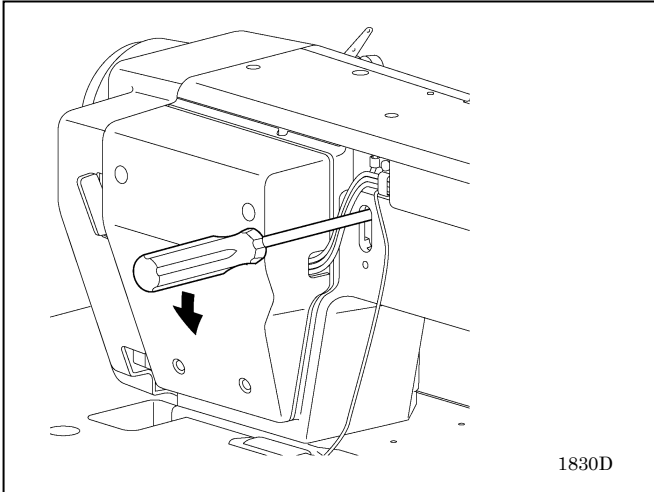

1. Turn off the power of the sewing machine.
2. Remove the rubber cap, insert a screwdriver or similar tool into the hole and pass it through the hole in the lifting lever.
3. In this condition, push down the screwdriver.

[NOTE]

Do not turn on the power of the sewing machine while the screwdriver or similar tool is still inserted.

8-3. Using the presser foot hold plate

- The presser foot can be secured in the raised position.

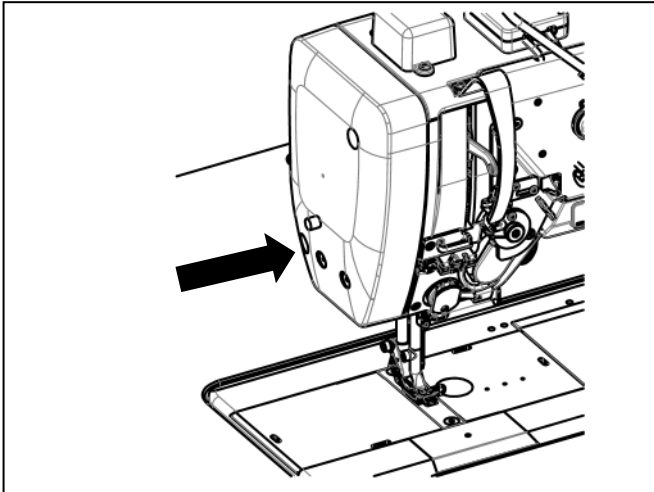

1. Depress the pedal backward to raise the presser foot.
2. Press the presser foot hold button in the face plate.
3. The presser foot will be held in the raised position.
4. When the pedal is depressed backward again and the presser foot is raised, the presser lifter hold will be released and the presser foot will drop.

[NOTE]

Do not depress the pedal forward while the presser foot is raised.

8-4. Status light bar

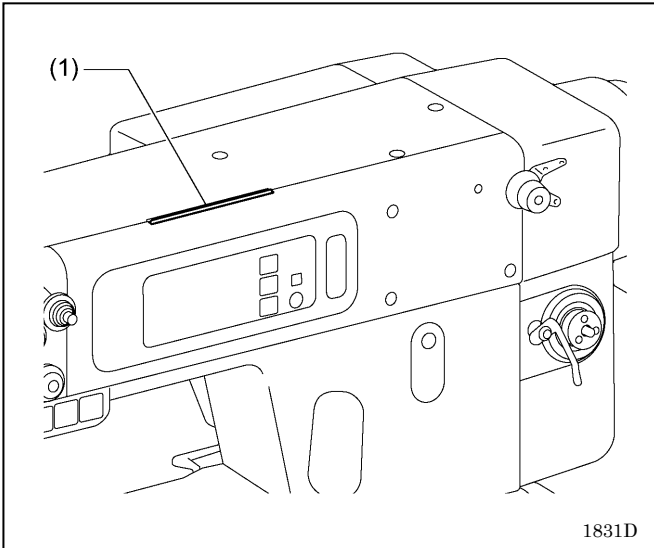

When the power is turned on, the status light bar (1) illuminates green.

If an error occurs, it illuminates red.

- * It illuminates yellow during hold mode.

9. STANDARD ADJUSTMENTS

9-1. Adjusting the thread tension



CAUTION







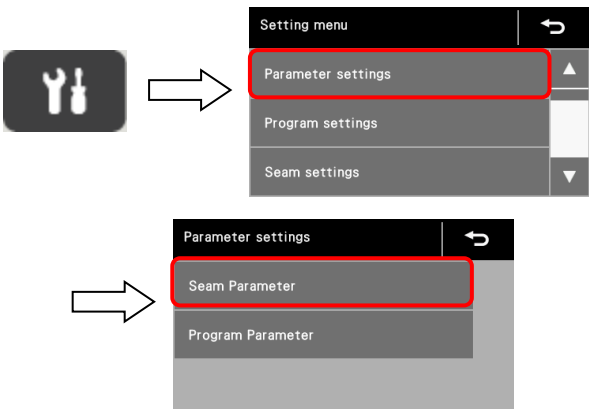

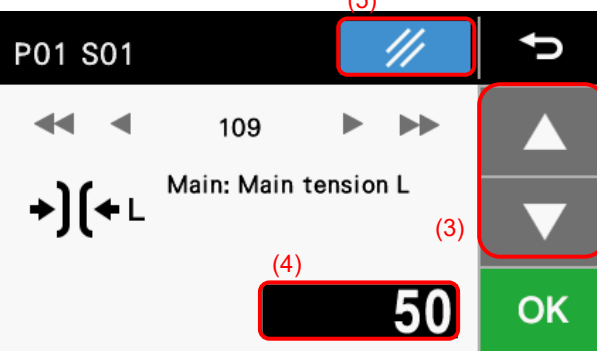
Turn off the power switch before removing or inserting the bobbin case. The machine may operate if the treadle is depressed by mistake, which could result in injury.

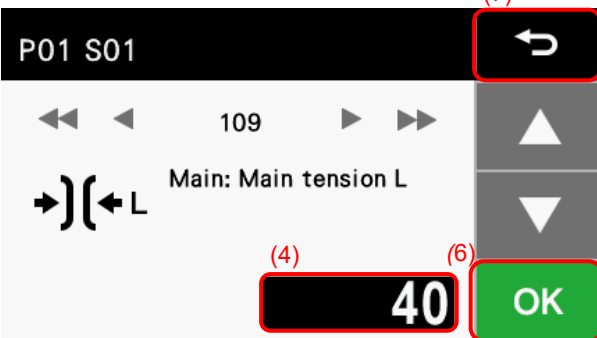

9-1-1. Upper thread tension adjustment

- The larger the number, the larger the upper thread tension will be.

<p>1</p>	<p>Switch to the seam parameter setting screen.</p> 	<p>Press the menu key to switch to the setting menu. Touch [Parameter settings] in the setting menu, and then touch [Seam parameter].</p>  <p>Switch to the seam parameter setting screen.</p>
<p>2</p>	<p>Select the parameter number for the parameter that you would like to change.</p> 	<p>Touch the [◀] or [▶] key (1) to select "Main: Main tension".</p> <ul style="list-style-type: none"> When you touch the [◀◀] or [▶▶] key (2), the parameters which have been changed from default settings will appear in order.
<p>3</p>	<p>Change the setting of the parameter.</p> 	<p>Touch the ▲ key or the ▼ key (3) to change the setting value (4).</p> <ul style="list-style-type: none"> If no setting value has already been set, the display will blink. <p>You can make the default setting appear in the display by touching the reset key (5).</p>

<p>4</p>	<p>Apply the changed setting.</p> 	<p>Touch the OK key  (6).</p> <ul style="list-style-type: none"> • The setting value (4) will stop blinking and illuminate, and this means that the setting is confirmed. • You can cancel the changes by changing the parameter number or touching the menu key  or the return key  (7) to switch the screen without touching the OK key.
<p>5</p>	<p>Exit setting mode </p>	<p>Press the return key  or the menu key .</p> <ul style="list-style-type: none"> • The display will return to the setting menu screen.

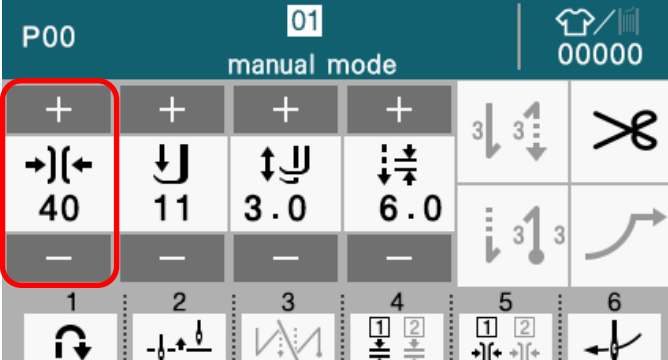
<When editing directly from the detailed home screen>

	<ul style="list-style-type: none"> • Touch the  key or the  key to change the value for the upper thread tension for the main sewing section. * The parameters which are displayed in the detailed home screen can be changed. If changing a parameter from its default setting, the screen may be different from the one shown at left.
--	---

9-1-2. Lower thread tension adjustment

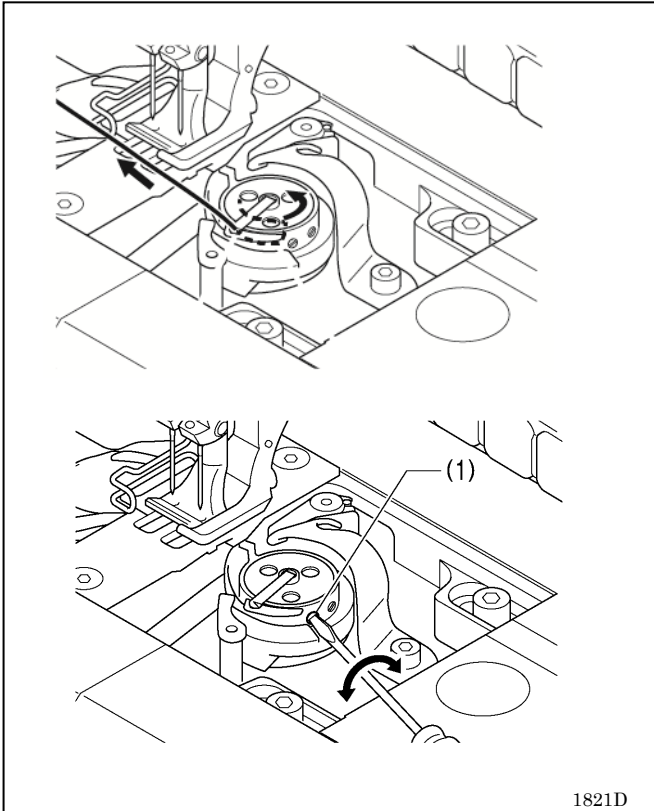

<Checking method>

Pull out from the bobbin opening at an angle of 80 ° (in the direction away from where the bobbin tab is hooked on) when measuring the tension.

<Adjustment method>

Turn the lower thread tension adjusting screw (1) to adjust.

9-2. Thread take-up amount of thread take-up springs

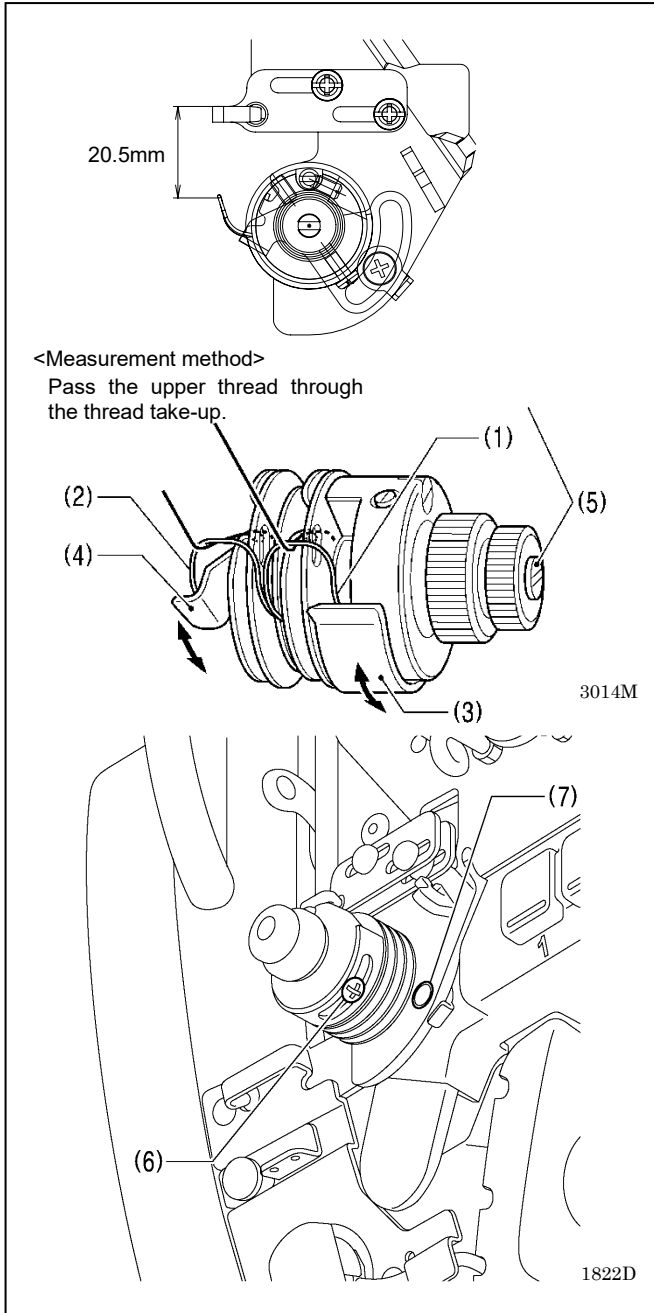

Adjust the thread take-up amount by changing the height of the thread take-up spring stoppers R (3) and L (4).

* The standard heights of thread take-up spring R (1) and L (2) are when the clearances between the top ends of the thread take-up springs and the arm thread guide are 20.5 mm.

<Adjustment method>

If the positions of the thread take-up spring stoppers are raised, the take-up amounts for the thread take-up springs become smaller.

Height of thread take-up spring stopper (L) (4) [for single needle specifications and left thread of twin-needle specifications]

1. Loosen the screw (7), and then slide the thread take-up spring stopper (L) (4) to adjust the height.
2. Tighten the screw (7).

Height of thread take-up spring stopper (R) (3) [for right thread of twin-needle specifications]

1. Loosen the screw (6), and then slide the thread take-up spring stopper (R) (3) to adjust the height.
2. Tighten the screw (6).

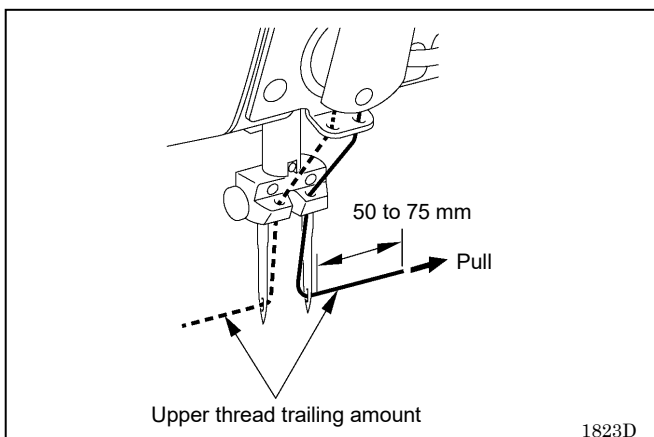

[NOTE]

The normal length is 50 to 75 mm when the upper thread is pulled out from the left-side upper needle hole after thread trimming. If the length is too short, reduce the sub-tension.

9-3. Thread take-up spring tension

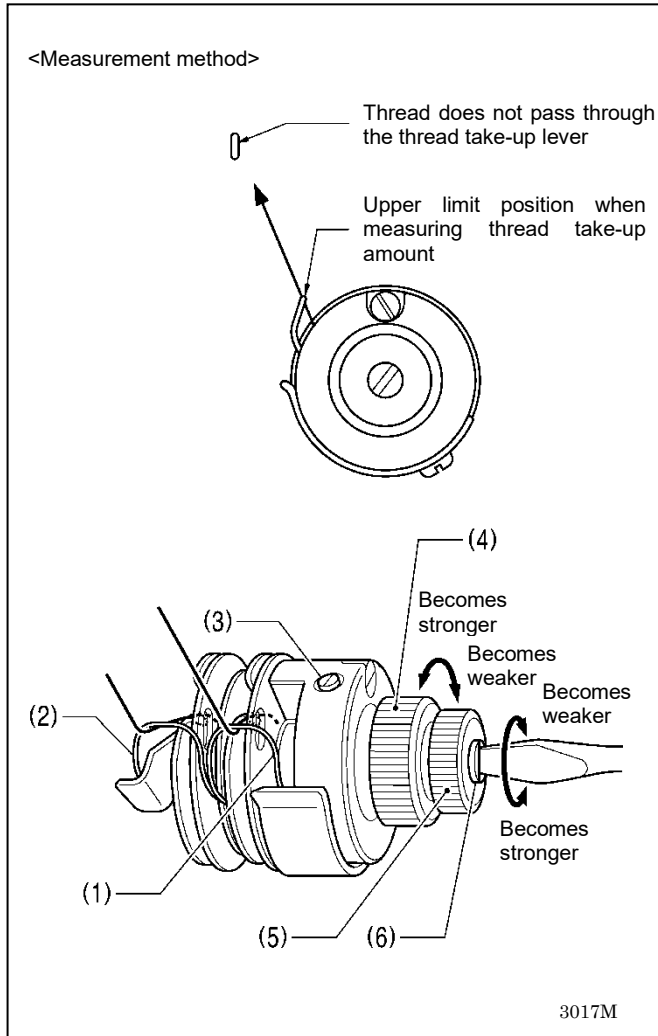

The standard tension for thread take-up spring R (1) and L (2) is 1.2N.

Measure the tension of the thread take-up spring by pulling the thread in the direction of the arrow shown in the diagram.

<Adjustment method>

Thread take-up spring (L) (2) [for single needle specifications and left thread of twin-needle specifications]

1. Loosen the thread tension nut (5).
2. Use a screwdriver (small) to turn the tension stud (6) to adjust the tension.
3. Tighten the thread tension nut (5).

Thread take-up spring (R) (1) [for right thread of twin-needle specifications]

1. Loosen the set screw (3), and then turn the adjustment nut (4) to adjust the tension.
2. Tighten the set screw (3).

9-4. Thread take-up amount (adjusting the arm thread guide)

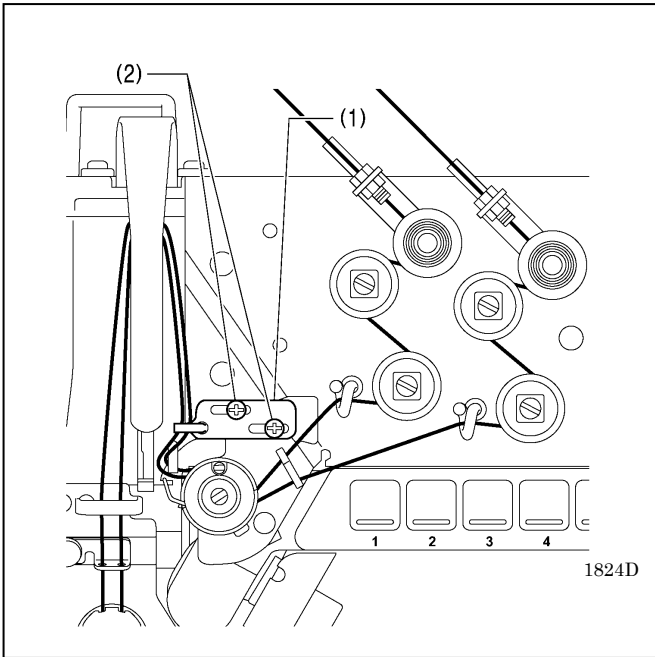



The standard position of thread guide R (1) is when the screw (2) is aligned with the right edge.

To adjust the position, loosen the screw (2) and then move thread guide R (1).

- When sewing heavy-weight material, move thread guide R (1) to the left. (The thread take-up amount will increase.)
- When sewing light-weight material, move thread guide R (1) to the right. (The thread take-up amount will decrease.)
- For twin-needle specifications, the thread mounts for the right side and the left side can be adjusted separately.

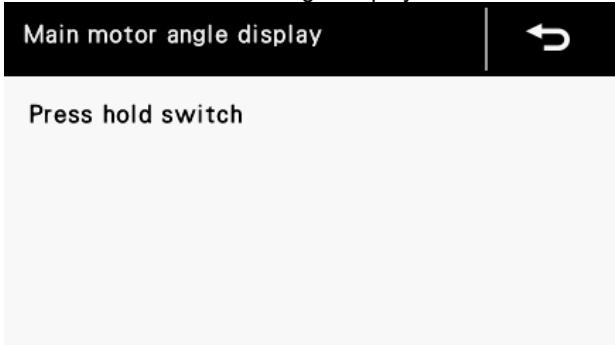
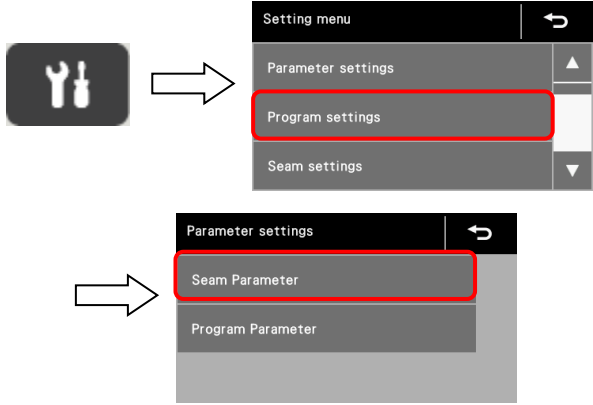
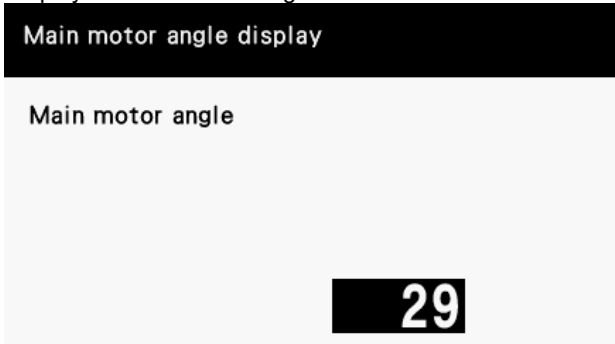
9-5. Needle and rotary hook timing

<p>1 Switch to the main motor angle display screen.</p> 	<p>Press the menu key to switch to the setting menu. Touch [Main motor angle display] in the setting menu, and then touch [Pulse motor excitation on].</p>  <p>The display will switch to the main shaft angle display screen.</p>
<p>2 Display the main motor angle.</p> 	<p>Press the hold key (1) to display the angle.</p> <p>Turn the pulley to move the needle to its lowest position, and then turn the pulley a further +23° from that angle (Reference: about 203°).</p> 

9. STANDARD ADJUSTMENTS

3

Adjust the needle and rotary hook timing.

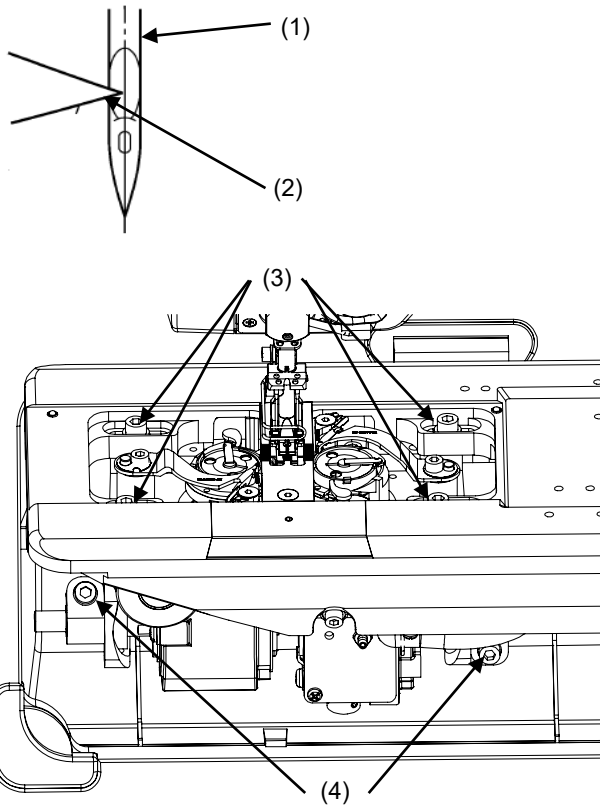

Tilt back the machine head, and then loosen the screw (4) of the set collar on the lower shaft and turn the rotary hook to change the position of the rotary hook tip so that the center of the needle (1) and the rotary hook tip (2) are aligned at the current main shaft angle.

4

Adjust the needle clearance.

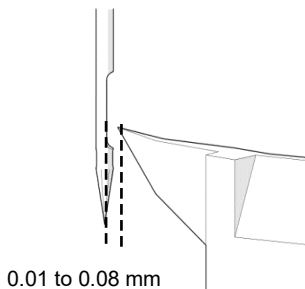

Turn the pulley in the direction of the arrow to align the rotary hook tip with the center of the needle, and then move the rotary hook base to adjust so that the clearance between the needle and the rotary hook tip is 0.01 to 0.08 mm.

Loosen the two socket bolts (four for twin-needle specifications) (3) and the socket bolt (two for twin-needle specifications) (4) to adjust the position of the rotary hook base. After adjusting, check the adjustment of the needle and rotary hook tip timing.

5

Secure the rotary hook base.

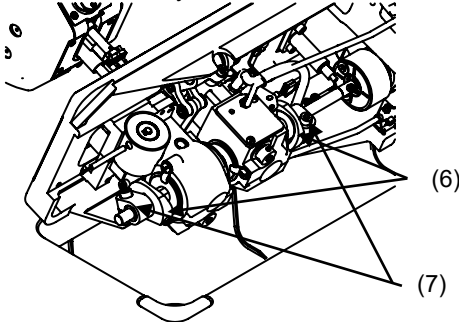

Once again, check the needle and rotary hook timing, and then tighten the two socket bolts (four for twin-needle specifications) (3) and the socket bolt (two for twin-needle specifications) (4) to secure the rotary hook base.

Place the set collar (7) against the thread trimming cam (6) and secure it.

6

Exit setting mode



Press the return key  or the menu key .

The display will return to the setting menu screen.

9-6. Adjusting the thread trimming

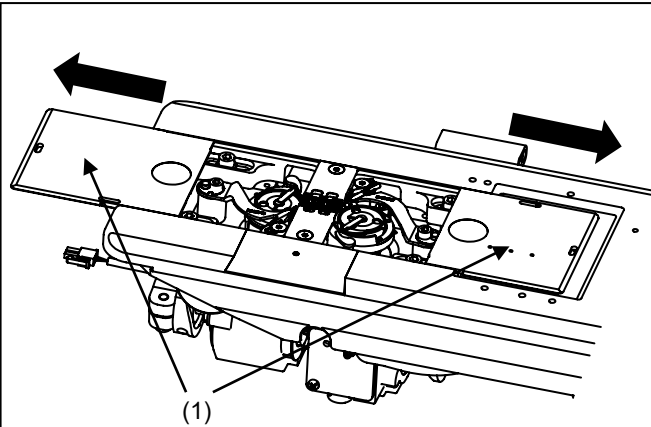

1. Move the slide plates (1) to the side.
2. Turn the pulley to the angle (between 260° and 310° as a guide) where the movable knife (2) starts to move.
3. Loosen the screw (3).
4. Move the movable knife by hand to the position where it starts to mesh with the fixed knife (4), adjust the fixed knife so that the tip of the fixed knife and the arrow mark on the movable knife are aligned, and then tighten the screw (3) of the fixed knife.

[NOTE]

When screw (3) is tightened, tighten it in the direction where the fixed knife moves away from the movable knife. Place something in between the gap between the fixed knife and the needle plate to stop the fixed knife from moving.

[NOTE]

When the screw (3) is loosened, the lower thread hold spring (5) will also be released. When tightening the screw (3), place the lower thread hold spring (5) against the movable knife (2) at the position where the movable knife (2) and the fixed knife start to mesh, and then tighten the screw (3).

<Position where movable knife and fixed knife start to mesh>

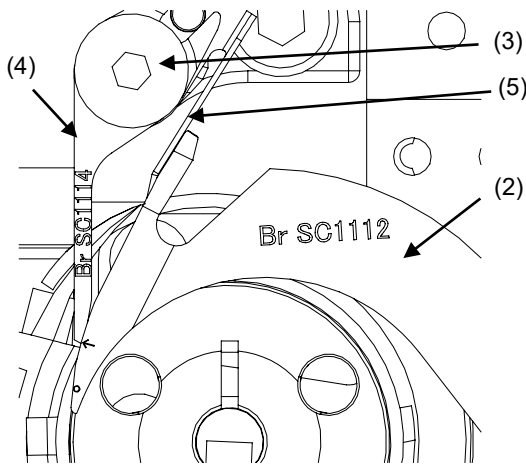

<Movable knife standby position>

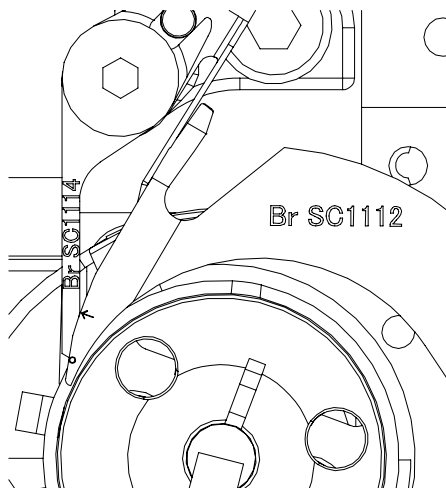

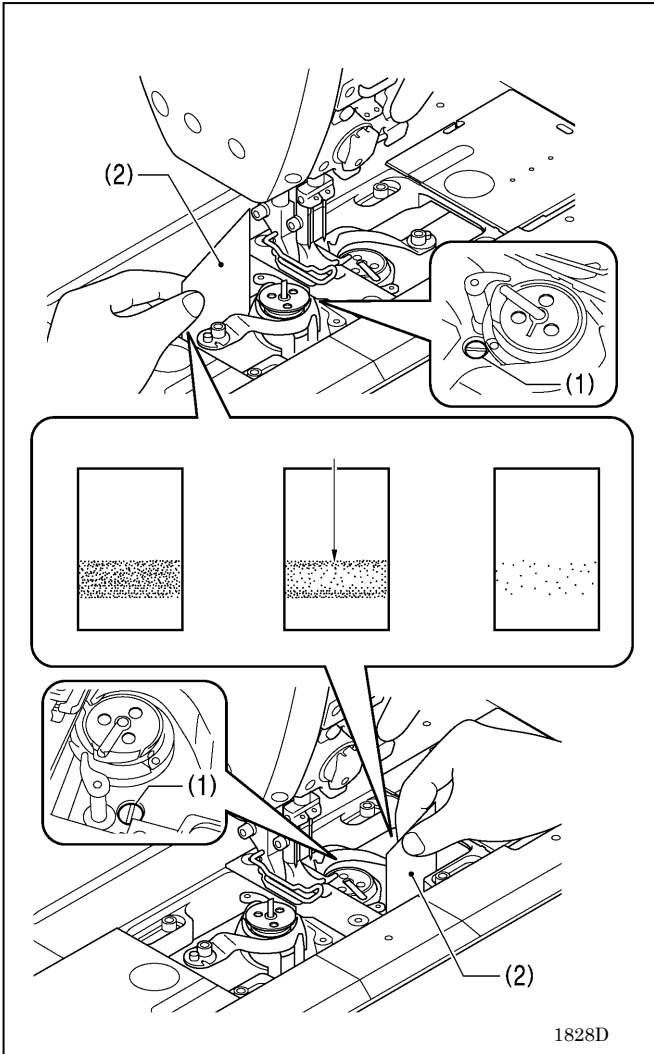

9-7. Adjusting the rotary hook lubrication amount



1. Move the slide plates.
2. Adjust the lubrication amount for the rotary hook using the set screw (1). When it is turned clockwise, the lubrication amount decreases, and when it is turned counterclockwise, the lubrication amount increases.
3. Operate the sewing machine at 2,000 rpm for about 15 seconds.
4. The appropriate amount is when a piece of paper is placed on the outer part of the rotary hook base as shown in the diagram and the sewing machine is operated at 2,000 rpm for 5 seconds, oil streaks appear on the paper.

10. CLEANING

CAUTION

-  Turn off the power switch before lubricating the sewing machine.
The machine may operate if the treadle is depressed by mistake, which could result in injury.
-  Be sure to wear protective goggles and gloves when handling the lubricating oil and grease so that they do not get into your eyes or onto your skin. Otherwise inflammation can result.
Furthermore, do not drink the lubricating oil or eat the grease under any circumstances. Diarrhea or vomiting may result.
Keep the oil out of the reach of children.

10-1. Cleaning

10-1-1. Cleaning the rotary hook base

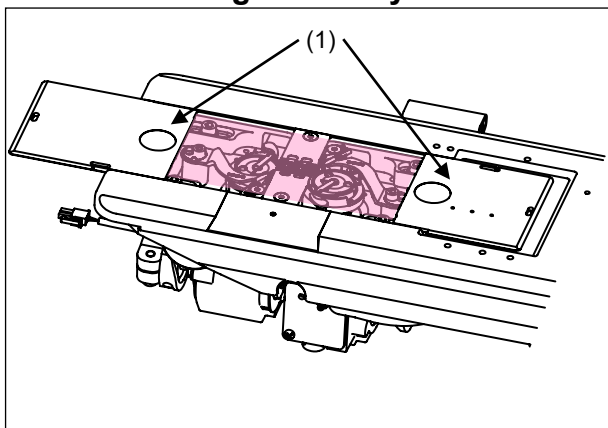

1. Open the slide plates (1).
2. Remove any foreign materials such as cotton scraps which are adhering to the rotary hook, movable knife and fixed knife.
3. Close the slide plates.

[NOTE]

Use tweezers or similar when cleaning around the rotary hook, and be careful not to damage the rotary hook.

10-1-2. Cleaning the oil pan

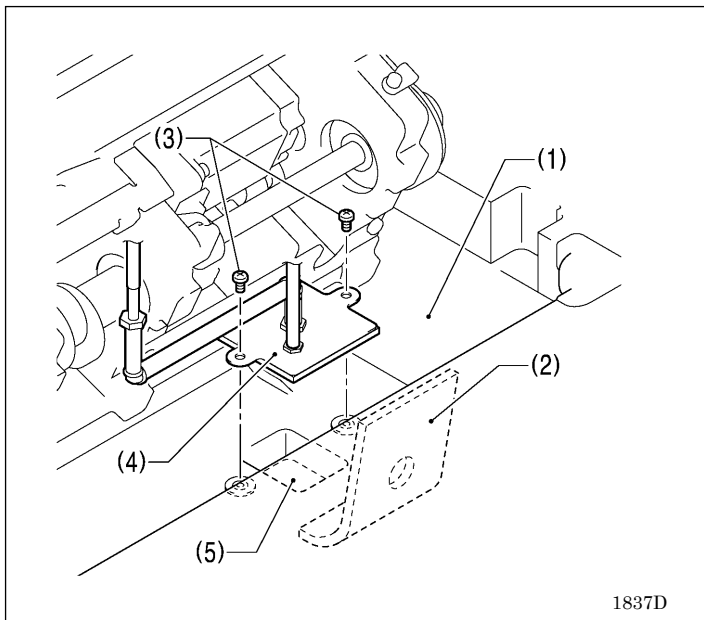

1. Tilt back the machine head.
2. Clean away any foreign materials from inside the oil pan (1). Clean away any foreign materials which are on top of the sponge (2).
3. Loosen the two screws (3).
4. Slide the oil pan cover (4) and clean away any foreign materials from the oil sump (5).
5. Install the oil pan cover (4) with the two screws (3).
6. Remove any foreign materials from the top of the sponge on the left side of the oil pan.

- * The oil pan should be cleaned about once a month.
- * Before removing any foreign materials, it is recommended that you remove the oil from the oil pan to make the work easier.

1837D

10-2. Replacing the filter tube assembly

If the amount of oil in the oil tank decreases rapidly, there may be a blockage in the filter tube assembly which is located in path for the sewing machine oil which is recovered from the oil tank. Replace the filter tube assembly to return the circulation of the sewing machine oil to normal.

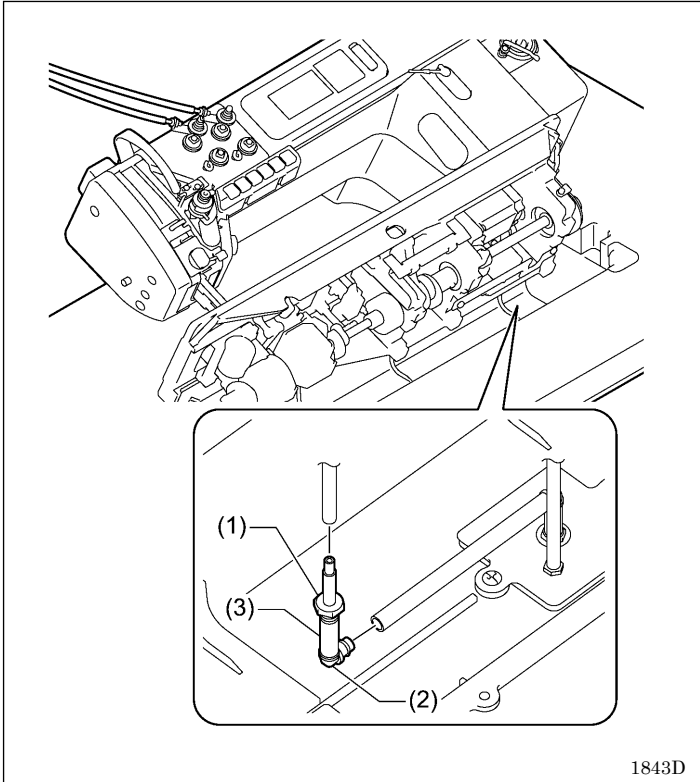

1. Tilt back the machine head.
2. Disconnect the tubes from the tube joint (1) and the L-shaped joint (2).
3. While holding the new filter tube assembly (3), connect the tube joint and the L-shaped joint to replace the assembly.

* It is recommended to check the oil flow in the filter tube assembly of the oil pan is blocked or clogged once in every three months. Please replace it if the flow is blocked or clogged.

10-3. Adding grease (when the grease up warning is displayed)

If the grease up warning is displayed when the power switch is turned on, it is to notify you that it is time to apply grease. (The sewing machine will not operate at this time, even if the pedal is depressed.)
Apply grease as required, referring to the following for details.

<To continue sewing temporarily without applying grease>

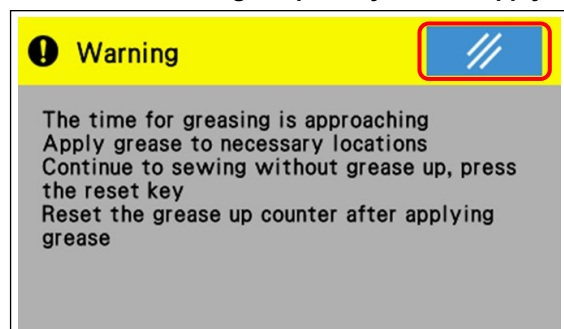

1. Press the reset key .
2. After you return to the home screen, you can depress the pedal to resume sewing.

[NOTE]

- The grease up warning will continue to be displayed each time the power is turned on until the grease is applied and the initialization operation on page 100 is carried out.
- If you continue to use the sewing machine after the grease up warning is displayed without applying grease (or without carrying out the initialization procedure), "E100" will appear after a certain period of time and the sewing machine will be forcibly prevented from operating for safety reasons. If this happens, apply grease and carry out the initialization procedure.

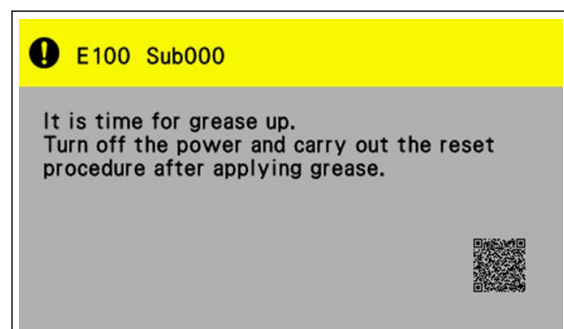

- * If you continue to use the sewing machine after carrying out the initialization procedure but without applying grease, problems with the sewing machine may result.

It is recommended that you apply grease to the following places. Use Brother-specified grease <Grease kit (for other than Europe: SA8771-101, for Europe: SB6659-201)>.

1. Using the tube

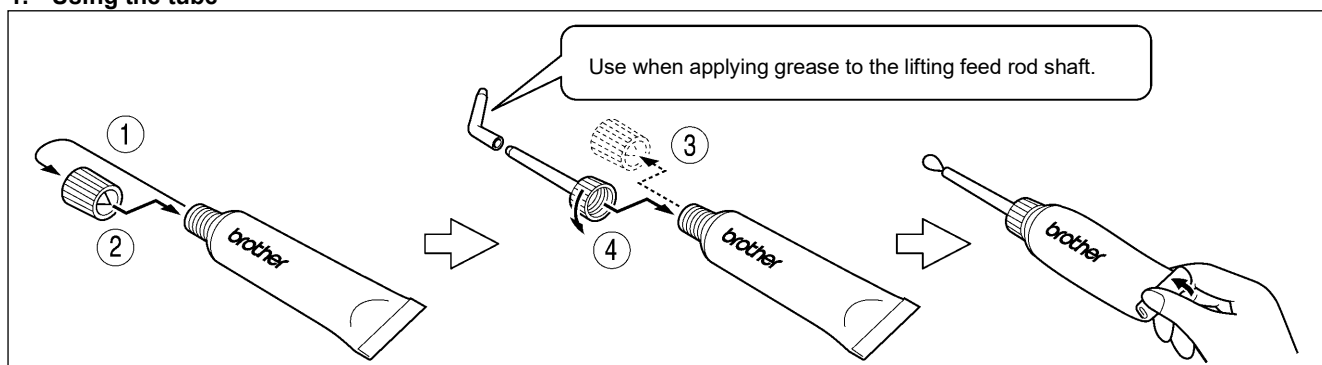

10. CLEANING

[NOTE]

- Once the grease tube has been opened, remove the nozzle from the tube, attach the cap securely and store the tube in a cool dark place.
- The grease should be used as quickly as possible.
- When using the grease again, remove any old grease from inside the nozzle first.

(Store the tube away carefully once the tube has been opened, otherwise the grease remaining inside the tube may deteriorate, and this may affect its lubricating performance.)

2. Applying grease

Apply grease to the lifting feed rod shaft and to the upper feed bar bush.





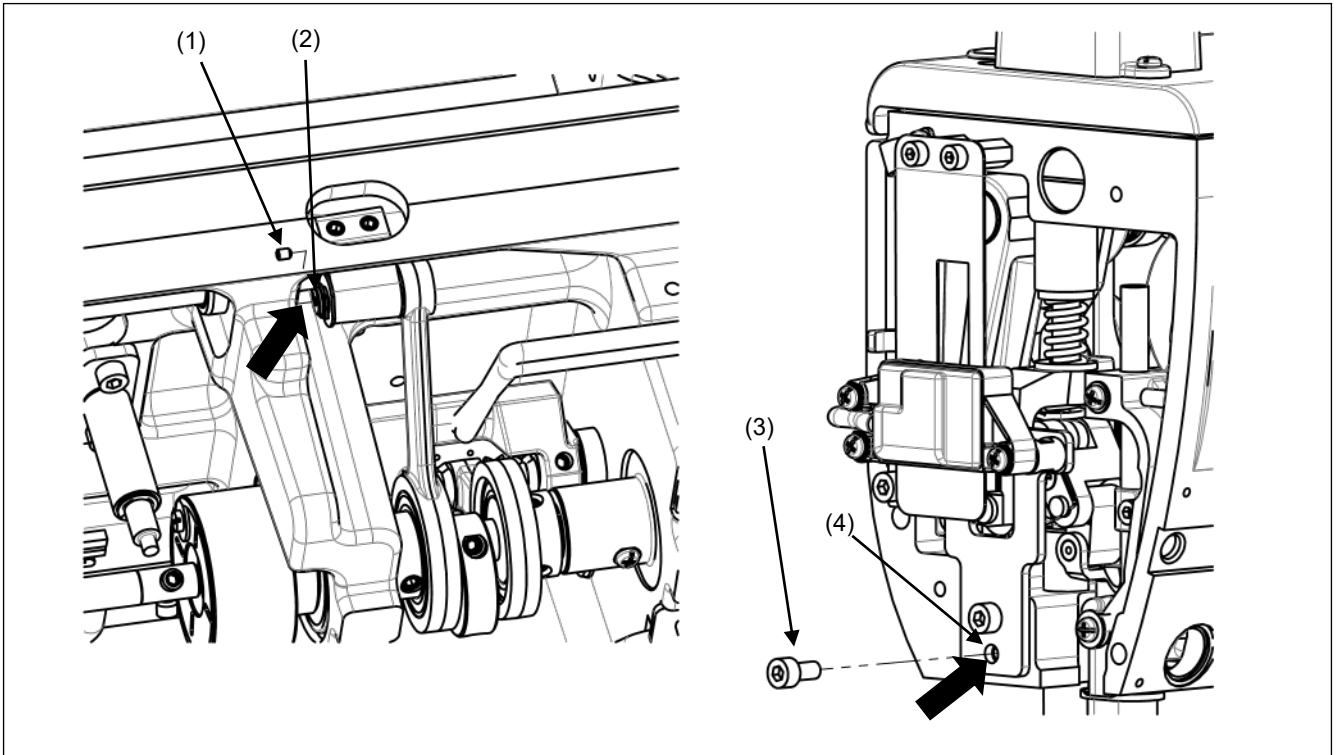

When applying grease to the lifting feed rod shaft, remove the set screw (1) and apply grease through the hole in (2).

When applying grease to the upper feed bar bush, loosen the socket bolt (3) and apply grease through the hole in (4).

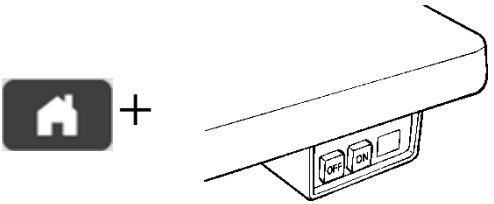
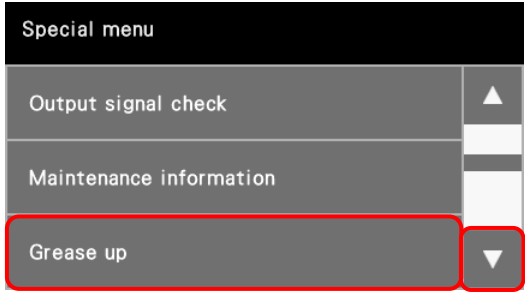

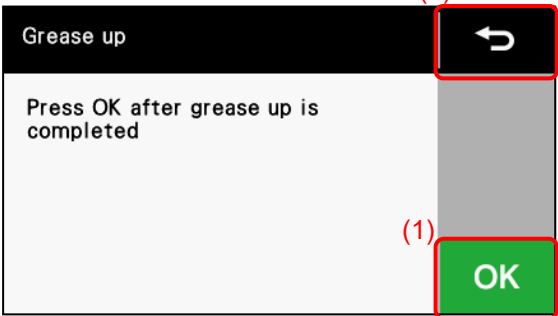
3. Grease-up counter initialization method

After the grease has been applied, carry out the following procedure to reset the cumulative number of stitches between grease applications.

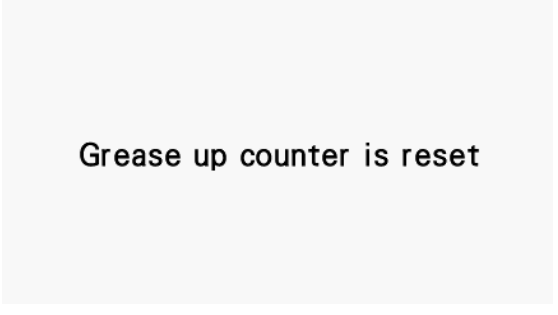
<p>1</p>	 <p>4421Q</p> <p>(While pressing the home key, turn on the power.)</p>	 <p>The special menu screen will be displayed. Press the  key to display "Grease up", and then press "Grease up".</p>
<p>2</p>		<p>When you press the OK key  (1), the grease up counter will be cleared.</p> <ul style="list-style-type: none">You can cancel the clearing of the grease up counter by changing the parameter number or touching the menu key  or the return key  (2) to switch the screen without touching the OK key.
<p>3</p>		<p>This completes the clearing operation.</p>

11. LIST OF ERROR CODES

LIST OF ERROR CODES

If an error code appears on the touch panel display

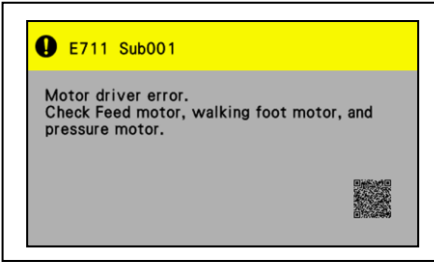

A QR code (*) will be displayed on some of the error codes. The QR code is a link to content in the Brother GT/ISM support application that is applicable to that error code.

* "QR code" is a registered trademark of Denso Wave Incorporated.

- Items with a "*" in the "Page" column should only be checked by a qualified technician.
- For items with "**" appearing in the "Page" column, contact the place of purchase.

<Connector layout diagram>

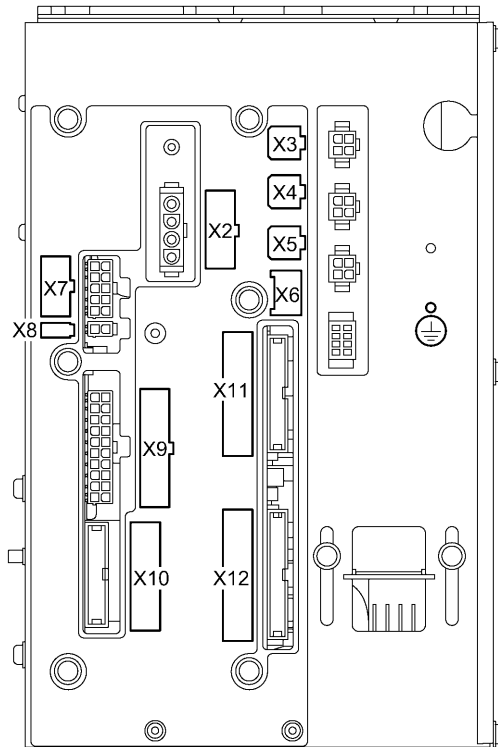

1850D

< Main P.C. board >

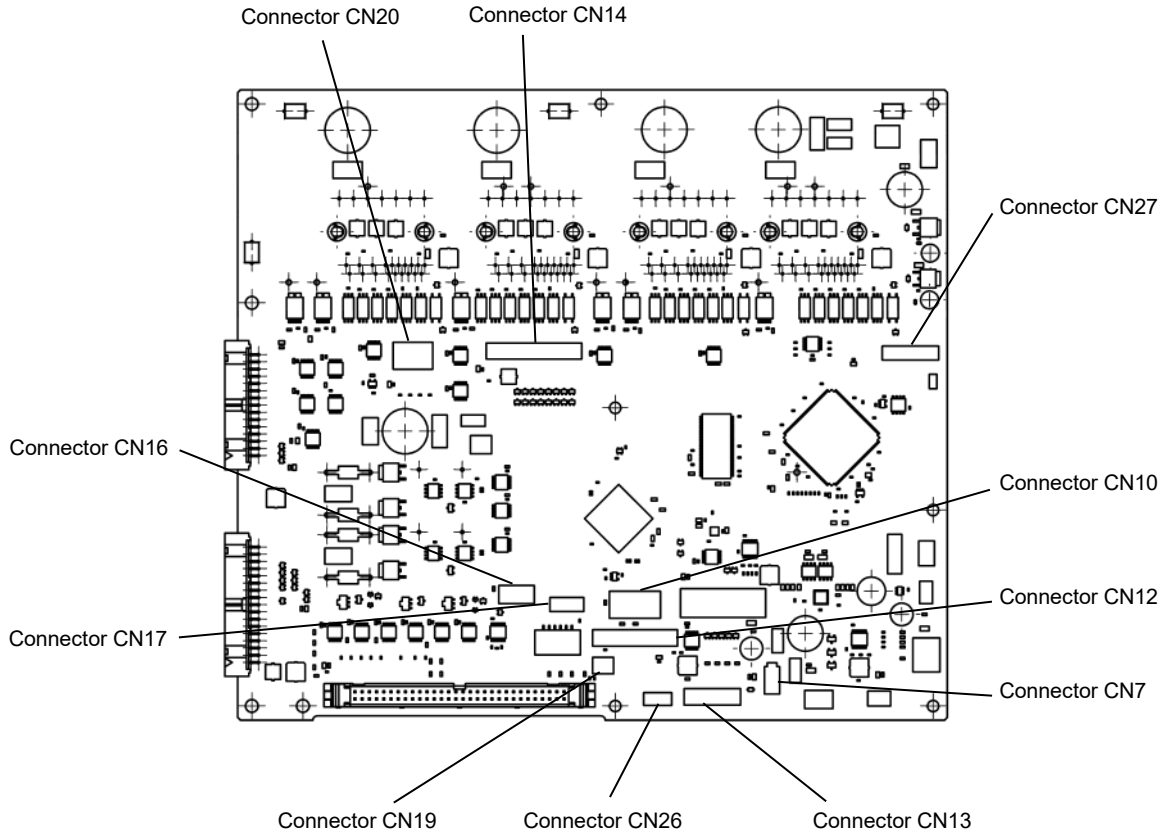

< Motor P.C. board >

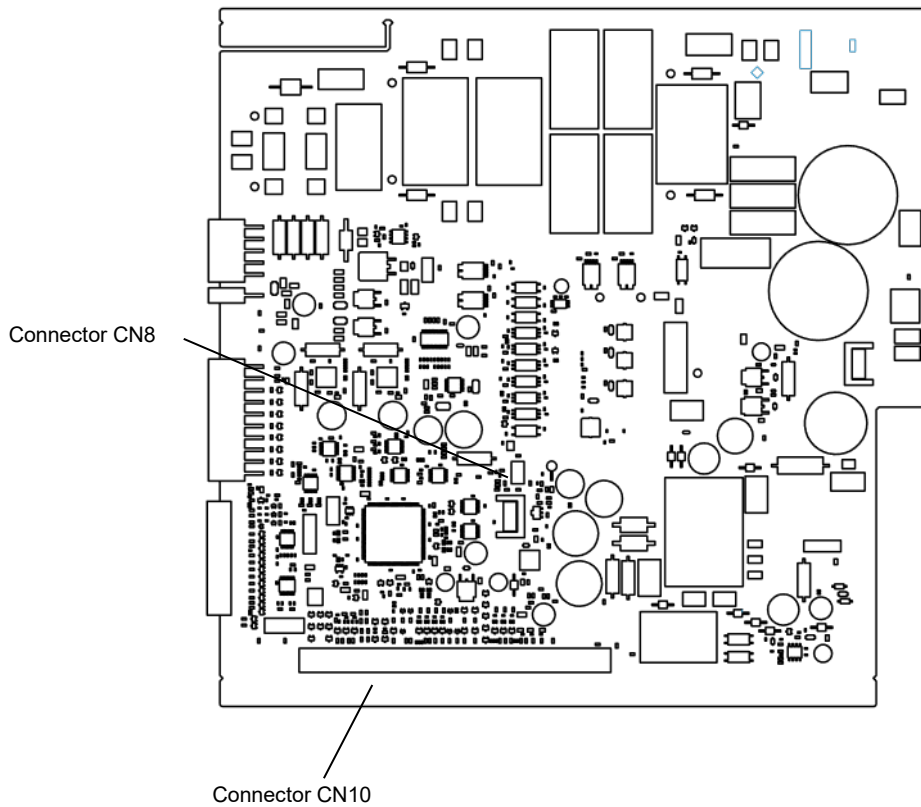

11. LIST OF ERROR CODES

<Side plate relay P.C. board>

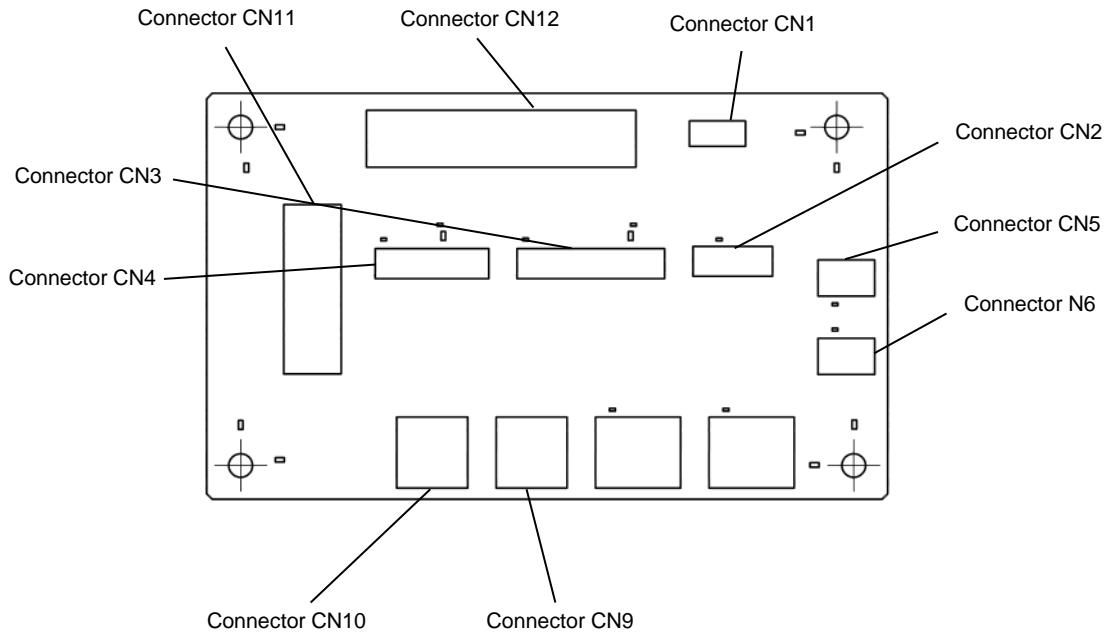

<Motor lower relay P.C. board>

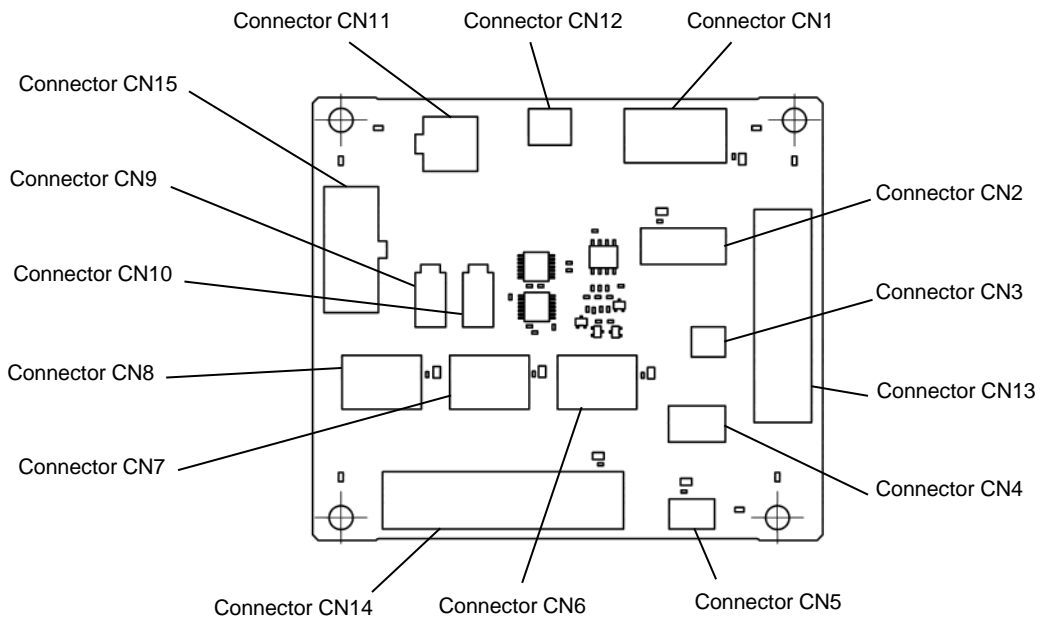

<Panel main P.C. board>

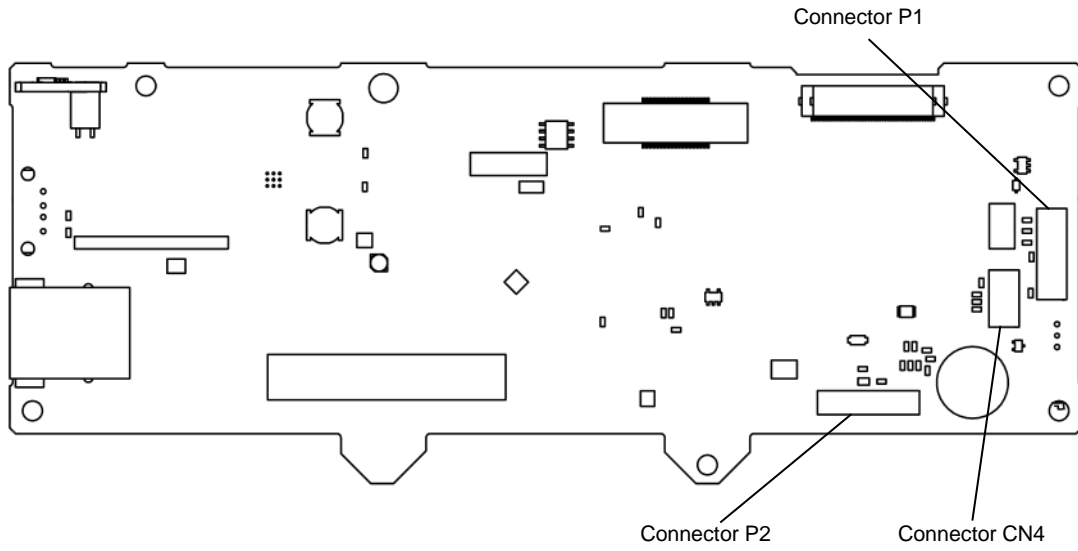

11. LIST OF ERROR CODES

Switch-related errors

Code	Cause	Remedy
E051	The machine head is detected as being tilted back.	<ul style="list-style-type: none"> • Turn off the power check the following. • Check the connection of connectors CN4 and CN14 below the main motor. • Check the connection of connector X11 at the side of the control box.
E055	The machine head is detected as being tilted back when power was turned on.	<ul style="list-style-type: none"> • Turn off the power and return the machine head to its original position. • Turn off the power and check that connectors CN4 and CN14 are connected to the motor lower relay P.C. board. • Check the connection of connector X11 on the side of the control box.
E064	The touch panel was being pressed when power was turned on.	Turn the power off and then back on again. * Do not press the touch panel when you turn on the power. Also clean the gaps at the frame of the panel.
E065	The operation panel key was being pressed when the power was turned on.	Turn the power off and then back on again. * Do not press the operation panel key when turning on the power other than the designated keys.
E066	The hand switch was being pressed when the power was turned on.	Turn the power off and then back on again. * Do not press the hand switch when turning on the power.
E080	One or more of the 6 function buttons were being pressed when the power was turned on.	Turn the power off and then back on again. * Do not press the 6 function buttons when turning on the power.
E081	The jog dial switch was being pressed when the power was turned on.	Turn the power off and then back on again. * Do not press the jog dial switch when turning on the power.
E082	The bobbin winding switch is still turned on. Turn it off. * Only when memory switch No. 856 is set to ON.	Turn the bobbin winding switch to OFF.
E083	The hold key was being pressed when a reset was not possible.	Turn the power off and then back on again.
E090	Connection of the foot pedal unit was not detected when power was turned on.	Turn off the power and check that connector CN8 is connected to the main P.C. board.
E095	Foot pedal or 3-step pedal was being pressed when power was turned on.	Return the foot pedal or the 3-step pedal to the neutral position.

Main motor-related errors

Code	Cause	Remedy
E100	It is time for grease up.	Turn off the power and carry out the reset procedure after applying grease.
E112	Main motor stopped before reaching the specified needle up or down position.	Turn off power and check whether main motor or thread trimming mechanism is heavy or not.
E113	The needle down stop position exceeded the specified value when the main motor stopped.	Turn off power and check whether main motor or thread trimming mechanism is heavy or not.
E130	Main motor did not operate at sewing start or during sewing.	<ul style="list-style-type: none"> • Turn off power and check whether main motor is heavy or not. • Turn off the power and check that connectors X2 and X10 are connected to the side of the control box, and that connectors CN1 and CN13 are connected to the motor lower relay P.C. board.
E131	Main motor encoder connection was not detected when power was turned on.	Turn off the power and check that connector X10 is connected to the side of the control box, and that connectors CN1 and CN13 are connected to the motor lower relay P.C. board.
E132	Abnormal speed of main motor was detected during sewing.	Turn off the power and check that connector X10 is connected to the side of the control box, and that connectors CN1 and CN13 are connected to the motor lower relay P.C. board.
E140	Main motor ran in opposite direction to the direction specified during sewing.	Turn off the power and check that connector X10 is connected to the side of the control box, and that connectors CN1 and CN13 are connected to the motor lower relay P.C. board.
E150	Abnormal overheating detected in main motor.	Turn off the power and then check the sewing conditions.
E151	Connection of the main motor overheating sensor is not detected.	Turn off the power and check that connector X10 is connected to the side of the control box, and that connectors CN1 and CN13 are connected to the motor lower relay P.C. board.

Code	Cause	Remedy
E161	Overload is detected with the main motor during sewing.	Turn off the power and check the sewing conditions.
E190	Main motor operated continuously exceeding the limit during sewing.	Turn the power off and then back on again.
E191	Thread trimming did not complete within a certain period.	Turn off the power and check if the thread trimming mechanism is stiff.

Feed mechanism-related errors

Code	Cause	Remedy
E200	Home position of the feed motor cannot be detected.	<ul style="list-style-type: none"> • Turn off the power and check that the feed mechanism is not abnormal. • Turn off the power and check that connectors X5 and X11 are connected to the side of the control box, and that connectors CN8 and CN14 are connected to the motor lower relay P.C. board.
E201	Feed motor stopped abnormally.	<ul style="list-style-type: none"> • Turn off the power and check that the feed mechanism is not abnormal. • Turn off the power and check that connectors X5 and X11 are connected to the side of the control box, and that connectors CN8 and CN14 are connected to the motor lower relay P.C. board. • Check that connectors CN1 and CN2 are connected to the main P.C. board.
E205	Feed motor encoder cannot be detected.	Turn off the power and check that connector X11 is connected to the side of the control box, and that connectors CN8 and CN14 are connected to the motor lower relay P.C. board.
E250	Feed motor overheating sensor caused overheating protection to be activated.	Turn off the power and check the sewing conditions.
E251	Feed motor overheating sensor connection could not be detected.	<ul style="list-style-type: none"> • Turn off the power and check the sewing conditions. • Turn off the power and check that connector X10 is connected to the side of the control box, and that connectors CN8 and CN14 are connected to the motor lower relay P.C. board.

11. LIST OF ERROR CODES

Presser foot-related errors

Code	Cause	Remedy
E300	Home position of the pressure motor cannot be detected.	<ul style="list-style-type: none"> Turn off the power and check that the presser foot mechanism is not abnormal. Turn off the power and check that connectors X3 and X11 are connected to the side of the control box, and that connectors CN6 and CN14 are connected to the motor lower relay P.C. board.
E301	Pressure motor stopped abnormally.	<ul style="list-style-type: none"> Turn off the power and check that the presser foot mechanism is not abnormal. Turn off the power and check that connectors X3 and X11 are connected to the side of the control box, and that connectors CN6 and CN14 are connected to the motor lower relay P.C. board. Check that connectors CN1 and CN2 are connected to the main P.C. board.
E305	Pressure motor encoder cannot be detected.	Turn off the power and check that connector X11 is connected to the side of the control box, and that connectors CN6 and CN14 are connected to the motor lower relay P.C. board.
E340	Walking foot motor is overheating.	<ul style="list-style-type: none"> Turn off the power and check that the presser foot mechanism is not abnormal. Turn off the power and check that connectors X4 and X11 are connected to the side of the control box, and that connectors CN7 and CN14 are connected to the motor lower relay P.C. board.
E341	Walking foot motor stopped abnormally.	<ul style="list-style-type: none"> Turn off the power and check that the presser foot mechanism is not abnormal. Turn off the power and check that connectors X4 and X11 are connected to the side of the control box, and that connectors CN7 and CN14 are connected to the motor lower relay P.C. board. Check that connectors CN1 and CN2 are connected to the main P.C. board.
E345	Walking foot motor encoder cannot be detected.	Turn off the power and check that connector X11 is connected to the side of the control box, and that connectors CN7 and CN14 are connected to the motor lower relay P.C. board.
E350	Presser foot motor overheating sensor caused overheating protection to be activated.	Turn off the power and check the sewing conditions.
E351	Presser foot motor overheating sensor connection could not be detected.	<ul style="list-style-type: none"> Turn off the power and check the sewing conditions. Turn off the power and check that connector X10 is connected to the side of the control box, and that connectors CN6 and CN14 are connected to the motor lower relay P.C. board.
E360	Walking foot motor overheating sensor caused overheating protection to be activated.	Turn off the power and check the sewing conditions.
E361	Walking foot motor overheating sensor connection could not be detected.	<ul style="list-style-type: none"> Turn off the power and check the sewing conditions. Turn off the power and check that connector X10 is connected to the side of the control box, and that connectors CN7 and CN14 are connected to the motor lower relay P.C. board.

Communication and memory-related errors

Code	Cause	Remedy
E400	Panel connection was not detected when power was turned on.	Turn off the power and check that connector X6 is connected to the side of the control box, that connector CN6 is connected to the main P.C. board, and that connector P2 is connected to the panel main P.C. board.
E401	Connection error with motor P.C. board detected when the power was turned on.	Turn off the power and check that connector CN21 on the main P.C. board and connector CN10 on the motor P.C. board are properly connected.
E405	Connection error with sewing error detection control P.C. board detected when the power was turned on. * Only when memory switch No. 855 is set to ON.	Turn off the power and check that connector CN11 is connected to the main P.C. board, and that connector P12 is connected to the error detection control P.C. board.
E410	Communication error with panel occurred when power was turned on.	Turn off the power and check that connector X6 is connected to the side of the control box, that connector CN6 is connected to the main P.C. board, and that connector P2 is connected to the panel main P.C. board.

Code	Cause	Remedy
E411	Communication error with motor P.C. board detected.	Turn off the power and check that connector X10 is connected to the side of the control box, and that connector CN21 is connected to the main P.C. board.
E415	Communication error with sewing error detection control P.C. board detected. * Only when memory switch No. 855 is set to ON.	Turn off the power and check that connector CN11 is connected to the main P.C. board.
E420	USB media is not connected or inserted.	Check that the USB media is correctly inserted.
E422	Error occurred when loading USB media.	<ul style="list-style-type: none"> • Press the reset key. • Check the files in the USB media.
E424	Lacking enough space of USB media.	<ul style="list-style-type: none"> • Press the reset key. • Increase the amount of free space in the USB media.
E425	Error occurred when loading USB media.	<ul style="list-style-type: none"> • Press the reset key. • Use the specified USB media.
E440	Data could not be written to the backup memory (on main P.C. board).	Turn the power off and then back on again.
E441	Data could not be read from the backup memory (on main P.C. board).	Turn the power off and then back on again.
E442	Back up memory (main internal P.C. board) data was abnormal, so settings were initialized.	Turn the power off and then back on again.
E450	Model settings could not be read from machine head memory (on panel).	Turn the power off and then back on again. Turn off the power and check the connection of P3.
E452	Machine head memory is not connected.	Turn the power off and then back on again.
E582	Detected error of memory switch version,	Turn off the power and carry out memory switch initialization.
E583	Detected error of parameter version.	Turn off the power and carry out program initialization.

Bobbin winder-related errors

Code	Cause	Remedy
E695	Home position of the winding motor cannot be detected. * This is only displayed when memory switch No. 856 is set to ON so that the bobbin winding mechanism is enabled	Turn off the power and check that connector X10 is connected to the side of the control box, and that connectors CN3 and CN13 are connected to the motor lower relay P.C. board.
E696	Winding motor stopped abnormally. * This is only displayed when memory switch No. 856 is set to ON so that the bobbin winding mechanism is enabled	Turn off the power and check that connector X7 is connected to the side of the control box, and that connectors CN11 and CN13 are connected to the motor lower relay P.C. board.

P.C. board-related errors

Code	Cause	Remedy
E700	Abnormal rise in power supply voltage was detected.	Turn off the power and then check the power supply voltage.
E701	Abnormal rise in power supply voltage of the main motor was detected.	<ul style="list-style-type: none"> • Turn off the power and then check the power supply voltage. • Turn off the power and check the connection of connector X2.
E705	Abnormal drop in power supply voltage was detected.	Turn off the power and then check the power supply voltage.
E707	Abnormal rise in power supply voltage of the main tension solenoid was detected.	Turn off the power and check that connector CN15 is connected to the main P.C. board.
E710	Abnormal current of the main motor was detected.	Turn off the power and check the connection of connector X2 on the side of the control box.
E711	Abnormal motor driver detected.	Check the feed, walking foot and presser foot motors.
E721	Overheating of the main motor IPM was detected.	Turn off the power, wait for a sufficient length of time for the component to cool down, and then turn the power back on again.
E740	Cooling fan in control box does not operate.	<ul style="list-style-type: none"> • Turn off the power and check if the cooling fan inside the control box is blocked with scraps of thread. • Turn off the power and check that connector CN8 is connected to the motor P.C. board.
E751	Material thickness sensor is not connected.	Turn off the power and check the connector of the material thickness sensor.

11. LIST OF ERROR CODES

Code	Cause	Remedy
E780	Malfunction of an element on the main P.C. board was detected.	Turn off the power and check the main P.C. board.
E791	Abnormal current of the main tension solenoid is detected when main tension solenoid is operating.	<ul style="list-style-type: none"> • Turn off the power and check the connection of connector X7 on the side of the control box. • Check that connector CN15 is connected to the main P.C. board.

Version update-related errors

Code	Cause	Remedy
E860	No main control software is present.	Install the main control software.
E880	Version update request could not be received when the power was turned on.	Turn off the power and check that connector X6 is connected to the side of the control box, that connector CN6 is connected to the main P.C. board, and that connector P2 is connected to the panel main P.C. board.
E881	Communication error was detected during version update.	Turn off the power and check that connector X6 is connected to the side of the control box, that connector CN6 is connected to the main P.C. board, and that connector P2 is connected to the panel main P.C. board.
E882	No USB media connected.	Turn off the power and check the connection of the USB media.
E883	Version update file could not be detected in USB media.	Turn off the power and then check that the version update file is contained in the USB media.
E884	There is a problem with the control program.	Turn off the power and check that the version update file in the USB media is correct.
E885	Communication error in USB media occurred during version updating.	Turn off the power and check the connection of the USB media.
E886	Abnormal version update file detected during version updating.	Turn off the power and check that the version update file in the USB media is correct.
E887	Version update file could not be written during version updating.	Turn off the power, and then repeat the version update procedure.
E888	Error sending or receiving version update file.	Turn off the power, and then repeat the version update procedure.
E889	Incorrect data has been written to flash memory.	Turn off the power, and then repeat the version update procedure.
E890	Error occurred during version update.	Turn off the power, and then repeat the version update procedure.

If an error code that is not listed above appears or if carrying out the specified remedy does not solve the problem, contact the place of purchase.

12. TROUBLESHOOTING

- Check the following points before calling for repairs or service.
- If the following remedies do not fix the problem, turn off the power switch and consult a qualified technician or the place of purchase.

DANGER



Wait at least 5 minutes after turning off the power switch and disconnecting the power cord from the wall outlet before opening the control box cover. Touching areas where high voltages are present can result in severe injury.

CAUTION



Turn off the power switch and disconnect the power cord before carrying out these operations. The sewing machine may operate if the treadle is depressed by mistake, which could result in injury.

12-1. Upper thread breakage or lower thread breakage

* Items with a "*" in the "Page" column should only be carried out by a qualified technician.

Cause	Inspection	Remedy	Page
When threading the needle	Threading the upper thread	Thread the upper thread correctly.	23
	Threading the lower thread	Thread the lower thread correctly.	22
Thread path	Damaged or worn thread path mechanism parts	Buff to remove the damage, or replace the part. Take particular care to finish off the needle holes in the needle plate and the underside of the needle plate.	*
Upper thread amount	Arm thread path position	Adjust the arm thread path position.	92 *
Upper thread	Upper thread tension	Adjust the upper thread tension to the adequate tension.	87
Thread take-up spring	Thread take-up spring tension and height	Loosen the thread take-up spring tension or lower the height to such a degree that does not cause double hooking.	90, 91
Needle	Needle direction	Install the needle so that the long groove is facing the hook.	19
	Needle installation height	Insert the needle into the needle bar so that the end of the needle shank is touching the upper edge of the needle bar hole.	—
	Needle bending	Replace the needle.	—
	Needle tip broken or burred	Replace the needle.	—
	Needle and thread	Replace the needle with one which is suitable for the thread.	19
Lower thread	Lower thread tension	Adjust the lower thread tension to the adequate tension.	89

(Continued on next page)

12. TROUBLESHOOTING

* Items with a "*" in the "Page" column should only be carried out by a qualified technician.

Cause	Inspection	Remedy	Page
Rotary hook	Needle bar height and needle bar lift amount	Adjust the height of the needle bar. Adjust the needle and rotary hook timing.	*
	Gap between the needle and the rotary hook tip	Adjust the clearance between the needle and the rotary hook tip to 0.01 to 0.08 mm. (Set as large as possible but so that skipped stitches do not occur.) * Move the needle bar forward and back with your finger, and check that the rotary hook tip does not strike the needle.	92 *
	Lubrication amount for rotary hook.	Adjust the lubrication amount for the rotary hook.	95 *
	Is thread tangled inside rotary hook?	Remove the thread which is tangled in the rotary hook.	96 *
	Damage at needle tip or outside rotary hook	Buff to remove the damage, or replace the part. * The rotary hook specified for UF-8910/8920 should be used.	*
Feed dog	Damaged holes in feed dog	Buff to remove the damage, or replace the part. * The feed dog specified for UF-8910/8920 should be used.	*
Heating (of needle or thread)	Sewing speed	Reduce the sewing speed to a speed where thread breakages due to heat do not occur.	52

* Items with a "*" in the "Page" column should only be carried out by a qualified technician.

12-2. Skipped stitches at sewing start

Cause	Inspection	Remedy	Page
Thread tension	Upper thread tension	Adjust the upper thread tension to the adequate tension.	87
Sub-tension	Sub-tension tension too strong	Adjust by turning the thread tension nut.	—
Thread take-up spring	Thread take-up spring tension and height	Loosen the thread take-up spring tension or lower the height to such a degree that does not cause double hooking.	90, 91
Needle	Needle direction	Install the needle so that the long groove is facing the hook.	19
	Needle installation height	Insert the needle into the needle bar so that the end of the needle shank is touching the upper edge of the needle bar hole.	—
	Needle bending	Replace the needle.	—
	Needle tip broken or burred	Replace the needle.	—
	Needle count	Use a needle with a smaller count and which is suitable for the thread and material.	19
Needle bar play	Needle bar vertical or forward/back play	Eliminate the play from the needle bar, or replace the part.	*
Rotary hook	Rotary hook tip broken	Buff to remove the damage, or replace the part. * The rotary hook specified for UF-8910/8920 should be used.	*
	Needle bar lift amount	Adjust the needle bar lift amount. Adjust the needle and rotary hook timing.	*
	Needle guard	Adjust so that the needle guard does not hold the needle too much.	*
	Gap between the needle and the rotary hook tip	Adjust the clearance between the needle and the rotary hook tip to 0.01 to 0.08 mm. (Set as large as possible but so that skipped stitches do not occur.) * Move the needle bar forward and back with your finger, and check that the rotary hook tip does not strike the needle.	92 *
Movable knife Fixed knife	Needle sharpness	Use a whetstone to sharpen the knife, or replace the part. * The movable knife and fixed knife specified for UF-8910/8920 should be used.	94 *
Bobbin	Bobbin spinning amount	Adjust the anti-spin spring of the rotary hook, or replace the part.	22 *
Presser foot	Relationship between material and presser foot	Use a presser foot which is suitable for the material. • Replace the presser foot with one that has a narrower groove so that it presses the material at the needle drop position.	—
	Relationship between presser foot and sewing machine operation	• Lower the presser foot before starting the sewing machine. • Raise the presser foot after the sewing machine has stopped.	
Lower thread hold spring	Lower thread hold spring tension	Increase the tension of the lower thread hold spring so that the lower thread does not pull out.	94
Thread holder	Thread holder operation	Turn on the thread holder.	87

12. TROUBLESHOOTING

* Items with a "*" in the "Page" column should only be carried out by a qualified technician.

12-3. Skipped stitches occur while sewing

Cause	Inspection	Remedy	Page
When threading the needle	Threading the upper thread	Thread the upper thread correctly.	23
	Threading the lower thread	Thread the lower thread correctly.	22
Thread take-up spring	Thread take-up spring tension and height	Loosen the thread take-up spring tension or lower the height to such a degree that does not cause double hooking.	90, 91
Needle	Needle direction	Install the needle so that the long groove is facing the hook.	19
	Needle installation height	Insert the needle into the needle bar so that the end of the needle shank is touching the upper edge of the needle bar hole.	—
	Needle bending	Replace the needle.	—
	Needle tip broken or burred	Replace the needle.	—
	Needle count	Use a needle with a smaller count and which is suitable for the thread and material.	19
Rotary hook	Rotary hook tip broken	Buff to remove the damage, or replace the part. * The rotary hook specified for UF-8910/8920 should be used.	*
	Needle bar lift amount	Adjust the needle bar lift amount. Adjust the needle and rotary hook timing.	*
	Needle guard	Adjust so that the needle guard does not hold the needle too much.	92 *
	Gap between the needle and the rotary hook tip	Adjust the clearance between the needle and the rotary hook tip to 0.01 to 0.08 mm. (Set as large as possible but so that skipped stitches do not occur.) * Move the needle bar forward and back with your finger, and check that the rotary hook tip does not strike the needle.	92 *
Presser foot pressure	Presser foot pressure	Adjust the presser foot pressure to make it stronger.	—
Presser foot	Relationship between presser foot and sewing machine operation	<ul style="list-style-type: none"> • Lower the presser foot before starting the sewing machine. • Raise the presser foot after the sewing machine has stopped. 	23

* Items with a "*" in the "Page" column should only be carried out by a qualified technician.

12-4. Uneven stitches (1) ... Poor thread tightening

Cause	Inspection	Remedy	Page
Upper thread	Upper thread tension	Adjust the upper thread tension to the adequate tension.	87
Thread take-up spring	Thread take-up spring tension	<ul style="list-style-type: none"> • If the operation of the thread take-up spring is unstable, increase the tension of the thread take-up spring and also increase the stroke. • If there is a large variation in the upper thread trailing length, increase the tension of the thread take-up spring. • If the upper thread trailing length is too short, decrease the tension of the thread take-up spring. 	91 *
Lower thread	Lower thread tension	Adjust the lower thread tension to the adequate tension.	89
Bobbin	Damaged or worn bobbin	If the lower thread pulls out and the lower thread tension is uneven, replace the bobbin.	22
Opener	Opener timing	Adjust the opener so that it operates at a suitable timing.	*
Thread path	Damaged or worn thread path mechanism parts	Buff to remove the damage, or replace the part. Take particular care to finish off the needle holes in the needle plate and the underside of the needle plate.	*

12-5. Uneven stitches (2) ... Thread clamped

Cause	Inspection	Remedy	Page
Thread take-up spring	Thread take-up spring tension	<ul style="list-style-type: none"> • If the operation of the thread take-up spring is unstable, increase the tension of the thread take-up spring and also increase the stroke. • If there is a large variation in the upper thread trailing length, increase the tension of the thread take-up spring. • If the upper thread trailing length is too short, decrease the tension of the thread take-up spring. 	91 *
Bobbin	Bobbin rotation direction	Set the bobbin so that it turns in the opposite direction to the rotary hook when the lower thread is pulled out.	22
	Bobbin thread winding amount	Set the bobbin thread winding amount to 80% of full capacity.	21
	Damaged or worn bobbin	If the bobbin is not turning smoothly, replace the bobbin.	22
Rotary hook	Needle bar lift amount	Adjust the needle bar lift amount. Adjust the needle and rotary hook timing.	*

12. TROUBLESHOOTING

* Items with a "*" in the "Page" column should only be carried out by a qualified technician.

12-6. Uneven stitches (3) ... Poor upper thread winding (bird's nests at sewing start)

Cause	Inspection	Remedy	Page
Upper thread	Upper thread tension	Reduce the upper thread tension just far enough so that it does not have an effect on the thread tension (thread tightening).	87
	Upper thread trailing length too long or irregular	Adjust by turning the thread tension nut.	—
	Tension at sewing start	Change the setting for memory switch No. 551 to change the number of stitches for upper thread tension release at the sewing start. * Upper thread winding errors can be reduced without releasing the upper thread tension at the sewing start, but the upper thread will pull out more often.	—
Lower thread hold spring	Lower thread hold spring	Install the lower thread hold spring.	94
Thread take-up spring	Thread take-up spring tension	<ul style="list-style-type: none"> • If the operation of the thread take-up spring is unstable, increase the tension of the thread take-up spring and also increase the stroke. • If there is a large variation in the upper thread trailing length, increase the tension of the thread take-up spring. • If the upper thread trailing length is too short, decrease the tension of the thread take-up spring. 	90, 91 *

12-7. Uneven stitches (4) ... Puckering (excess tightening)

Cause	Inspection	Remedy	Page
Upper thread	Upper thread tension	Adjust the upper thread tension to the adequate tension.	87
Thread take-up spring	Thread take-up spring tension	If the operation of the thread take-up spring is unstable, increase the tension of the thread take-up spring and also increase the stroke.	91 *
	Thread take-up spring tension and height	Loosen the thread take-up spring tension or lower the height to such a degree that does not cause double hooking.	90, 91
Lower thread	Lower thread tension	Adjust the lower thread tension to the adequate tension.	89
Bobbin	Damaged or worn bobbin	If the lower thread pulls out and the lower thread tension is uneven, replace the bobbin.	22
Opener	Opener timing	Adjust the opener so that it operates at a suitable timing.	*
Needle	Needle tip broken or burred	Needle count	—
	Replace the needle.	Use a needle with a smaller count and which is suitable for the thread and material.	—
Rotary hook	Rotary hook tip broken	Buff to remove the damage, or replace the part. * The rotary hook specified for UF-8910/8920 should be used.	*
Presser foot pressure	Presser foot pressure	Decrease the presser foot pressure.	—
Feed dog	Adjusting the feed dog height	Adjusting the height of the feed dog	*

(Continued on next page)

* Items with a "*" in the "Page" column should only be carried out by a qualified technician.

12-8. Uneven stitches (5) ... Entire seam

Cause	Inspection	Remedy	Page
When threading the needle	Threading the upper thread	Thread the upper thread correctly.	23
	Threading the lower thread	Thread the lower thread correctly.	22
Thread path	Damaged or worn thread path mechanism parts	Buff to remove the damage, or replace the part. Take particular care to finish off the needle holes in the needle plate and the underside of the needle plate.	*
Thread scraps and dust	Outside of rotary hook Needle plate surface around needle holes	Remove the thread scraps and dust.	*
Upper thread	Upper thread tension	Increase the upper thread tension. (Adjust while viewing the seam.)	87
	Needle and thread	Replace the needle with one which is suitable for the thread.	—
Needle	Needle installation	Insert the needle into the needle bar so that the end of the needle shank is touching the upper edge of the needle bar hole.	—
	Needle count	Replace the needle with one with a higher count.	—
Lower thread	Lower thread tension	Adjust the lower thread tension to the adequate tension.	89
Bobbin	Damaged or worn bobbin	Buff to remove the damage on the bobbin or replace the part.	*
Presser foot pressure	Presser foot pressure	Decrease the presser foot pressure to a degree so that the material does not slip.	—
Feed dog	Adjusting the feed dog height	Adjusting the height of the feed dog	*

12. TROUBLESHOOTING

* Items with a "*" in the "Page" column should only be carried out by a qualified technician.

12-9. Upper thread pulling out

Cause	Inspection	Remedy	Page
Upper thread	Upper thread tension	Reduce the upper thread tension just far enough so that it does not have an effect on the thread tension (thread tightening).	87
	Upper thread trailing length too short	Turn on the thread pull-out prevention function.	22
	Upper thread trailing length too short or irregular	Adjust by turning the thread tension nut. * When using the thread nipper device, adjust the upper thread trailing length to 50 to 70mm.	—
	Tension at sewing start	Change the setting for memory switch No. 551 to change the number of stitches for upper thread tension release at the sewing start. * Pulling out of the upper thread can be reduced by releasing the upper thread tension at the sewing start, but the upper thread winding errors will occur more often.	—
Thread take-up spring	Thread take-up spring tension	Increase the tension of the thread take-up spring.	91 *
Rotary hook	Needle bar height and needle bar lift amount	Adjust the height of the needle bar. Adjust the needle and rotary hook timing.	—
	Outside of rotary hook Needle plate opening	Remove the thread scraps and dust.	96 *
Lower thread	Lower thread tension too weak	Increase the lower thread tension.	89
	Lower thread hold spring	Adjust the lower thread hold spring.	94
Sewing start speed	Slow start	Change the slow start pattern.	79
	1st stitch sewing speed	Reduce the sewing speed for the 1st stitch at the sewing start. (To around 600 to 1000 sti/min.)	79
Skipped stitches	Skipped stitches at sewing start	Refer to "12-2. Skipped stitches at sewing start".	174

12-10. Unstable upper thread trailing length (upper thread pulls out of needle)

Cause	Inspection	Remedy	Page
Sub-tension	Sub-tension tension	Decrease the sub-tension.	*
Thread trimming cam	Thread trimming cam	Check the phase of the thread trimming cam. Retard the thread trimming timing.	
Main tension	Main tension release	Check the release timing for the main tension. Advance the release timing.	
Thread take-up spring	Thread take-up spring tension	<ul style="list-style-type: none"> • If there is a large variation in the upper thread trailing length, increase the tension of the thread take-up spring. • If the upper thread trailing length is too short, decrease the tension of the thread take-up spring. • If the operation of the thread take-up spring is unstable, increase the tension of the thread take-up spring and also increase the stroke. 	135 *
Thread path	Damaged or worn thread path mechanism parts	Buff to remove the damage, or replace the part. Take particular care to finish off the needle holes in the needle plate and the underside of the needle plate.	*
Thread	Thread type	If using a slippery thread, turn the needle bar thread guide to increase the resistance.	*

* Items with a "*" in the "Page" column should only be carried out by a qualified technician.

12-11. Thread is not trimmed

Cause	Inspection	Remedy	Page
Sub-tension	Upper thread too long at sewing start	Turn the thread tension nut to adjust the upper thread trailing length to 50 to 70 mm.	—
Needle	Needle bar lift amount	Check the needle bar lift amount.	*
Lower thread	Lower thread tension too weak	Adjust the lower thread tension to make it stronger.	89
Main tension	Main tension release	Check the release timing for the main tension. Advance the release timing.	—
Movable knife	Movable knife sharpness	After sewing several stitches, turn the machine pulley by hand until the movable knife protrudes when the upper shaft is at an angle of about 200 °, and then keep turning the upper shaft and check that the thread is cleanly cut. If the thread is not cut, <ul style="list-style-type: none"> • Adjust the position of the upper movable knife. (Refer to below.) • Sharpen the movable knife. • Replace the movable knife. * The movable knife specified for UF-8910/8920 should be used.	94 *
	Movable knife height	If the upper thread and lower thread are not held, adjust the height of the movable knife so that the minimum clearance between the movable knife and the inner rotary hook is 0.2 to 0.4 mm.	
Fixed knife	Fixed knife sharpness	After sewing several stitches, turn the machine pulley by hand until the fixed knife protrudes when the upper shaft is at an angle of about 200 °, and then keep turning the upper shaft and check that the thread is cleanly cut. If the thread is not cut, <ul style="list-style-type: none"> • Adjust the position of the fixed knife. (Refer to below.) • Sharpen the fixed knife. • Replace the fixed knife. * The fixed knife specified for UF-8910/8920 should be used.	94 *
	Fixed knife installation position	Check that the fixed knife is installed so that the movable knife and fixed knife start meshing when the movable knife is at the position of the arrow. Check that the amount of meshing is appropriate	94 *
	Skipped stitches at sewing end	Refer to "12-2. Skipped stitches at sewing start".	*

12. TROUBLESHOOTING

* Items with a "*" in the "Page" column should only be carried out by a qualified technician.

12-12. Broken needle

Cause	Inspection	Remedy	Page
Needle	Needle direction	Install the needle so that the long groove is facing the hook.	19
	Needle installation height	Insert the needle into the needle bar so that the end of the needle shank is touching the upper edge of the needle bar hole.	–
	Needle bending	Replace the needle.	–
	Needle clogging	Replace the needle.	–
	Needle tip broken or burred	Replace the needle.	–
	Needle and thread	Replace the needle with one which is suitable for the thread.	133
	Feed timing	Adjusting the needle and feed timing	142
Rotary hook	Needle bar height and needle bar lift amount	Adjust the height of the needle bar. Adjust the needle and rotary hook timing.	92 *
	Gap between the needle and the rotary hook tip	Adjust the clearance between the needle and the rotary hook tip to 0.01 to 0.08 mm. (Set as large as possible but so that skipped stitches do not occur.) * Move the needle bar forward and back with your finger, and check that the rotary hook tip does not strike the needle.	92 *
Needle plate	Needle plate installation position	Adjust the forward/back position of the needle plate so that the needle goes into the center of the needle hole.	*

12-13. Rotary hook phases do not match

Cause	Inspection	Remedy	Page
Rotary hook protection device	Rotary hook protection device angle	Check if the rotary hook protection device is operating. The cause might be that the thread is tangled in the rotary hook. Open the slide plates and clean the rotary hook. Next, reset the rotary hook protection device.	*

12-14. Thread not tightening around cross over seam areas

Cause	Inspection	Remedy	Page
Feed dog	Adjusting the feed dog height	Increase the feed dog height.	*
Material thickness correction function	Material thickness correction function ON/OFF	The main tension can be made to change when the material thickness changes by turning on the material thickness correction function.	57

12-15. Feed not moving or is out of step

Cause	Inspection	Remedy	Page
Feed motor	Cord connection	Check if there are any problems with the connection and contacts of the feed motor connector at the side of the control box.	*
Feed home position	Incorrect feed home position	Adjust the home position of the feed motor.	*

* Items with a "*" in the "Page" column should only be carried out by a qualified technician.

12-16. Incorrect sewing pitch

Cause	Inspection	Remedy	Page
Needle plate	Needle plate size	The standard needle plate can only be used to sew at pitches of up to 9 mm. To sew pitches greater than 9 mm, use the special gauge.	–
Sewing speed	Sewing speed is too high.	Differences in the sewing pitch may occur due to the sewing speed. When increasing the sewing speed, make the sewing pitch slightly smaller in order to obtain the correct pitch.	–
Presser foot pressure	Presser foot pressure is too weak.	If the presser foot pressure is too weak, the material may not feed correctly. Increase the presser foot pressure.	–
Presser foot	Presser foot does not slide easily.	Replace the presser foot.	–
Walking foot stroke	Walking foot stroke is too low.	If the walking foot stroke is too low, the material may not feed correctly. Increase the walking foot stroke.	–
Feed dog	Adjusting the feed dog height	Increase the feed dog height.	–

12-17. Oil in oil tank decreasing too quickly

Cause	Inspection	Remedy	Page
Oil pan	Oil pan tube connections	If the oil pan tube and the lubricating pump and sub tank gear are not connected, the oil in the oil pan will not be recovered and the amount of oil in the oil tank will drop. Connect the tube and the lubricating pump and sub tank gear.	7
	Oil inside oil pan	If a constant amount of oil has not collected inside the oil pan, the oil may decrease quickly until it has collected inside the oil pan. Replace the amount of decrease.	7
	Dirty oil pan	If there is any dirt inside the oil pan, it may prevent recovery of the oil. Remove any thread scraps etc. from inside the oil pan.	96 *
	Dirty sponge or filter inside the oil pan	The sponge and filter in the sump of the oil pan may be blocked with foreign materials. Remove the oil pan cover and clean.	96 *

12-18. Lower thread is winding to one side or winding amount is incorrect

Cause	Inspection	Remedy	Page
Bobbin winder tension	Bobbin winder tension assembly height	Adjust the height of the bobbin winder tension assembly.	*
Bobbin presser	Bobbin presser position	Adjust the position of the bobbin presser.	*

12. TROUBLESHOOTING

* Items with a "*" in the "Page" column should only be carried out by a qualified technician.

12-19. Sewing machine does not operate at high speed.

Cause	Inspection	Remedy	Page
Sewing speed	Sewing speed too low	<ul style="list-style-type: none"> Check and adjust the sewing speed settings. Check and adjust the backtack sewing speed settings. 	52 *
Feed pitch	Feed pitch	If the feed pitch exceeds a certain pitch, a speed limit may be applied to the sewing speed.	46 *
Walking foot stroke	Walking foot stroke	If the walking foot stroke exceeds a certain amount, a speed limit may be applied to the sewing speed.	50 *
Treadle adjustment	Treadle depressed position	Check that the depression positions for the treadle are not incorrectly adjusted.	*

12-20. Sewing machine stops during sewing

Cause	Inspection	Remedy	Page
Fixed stitch sewing	Settings at operation panel	In main section setting mode, set the main sewing pattern to something other than "Fixed stitches".	*
Power supply voltage drop	Power supply voltage	<p>When the power supply voltage drops, the reset function may operate and the sewing machine may stop.</p> <ul style="list-style-type: none"> Measure the power supply voltage. Check if the power cord is too long or if too many appliances are being run from a single outlet. 	*
Sewing error detection	Sewing error detection function setting	<ul style="list-style-type: none"> When the sewing error detection function is turned on, the sewing machine will stop when a sewing error is detected. Check if a sewing error has occurred. Measure the power supply voltage. Check if the upper thread has been passed above the sensor during threading. 	54

12-21. Operation panel display freezes and operation is not possible

Cause	Inspection	Remedy	Page
Poor connection inside control box	P.C. board cord connections	<ul style="list-style-type: none"> Check if there are any problems with the connection and contacts of the connectors on the main P.C. board. Check if there are any problems with the connection and contacts of the connectors on the power supply motor P.C. board and on the operation panel. 	*

12-22. Sewing machine does not start when treadle is depressed after power is turned on

Cause	Inspection	Remedy	Page
Hold key	Hold mode ON/OFF	The sewing machine will not operate if hold mode is ON, so reset the hold mode.	—
Operation panel	Operation panel screen	Switch the operation panel to a screen where sewing is possible, such as the home screen.	—
Sewing error detection	Sewing error detection settings	When the sewing error detection function is turned on, the sewing machine will not operate when a sewing error is detected.	54

* Items with a "*" in the "Page" column should only be carried out by a qualified technician.

12-23. Sewing machine does not start when power is turned on

Cause	Inspection	Remedy	Page
Machine head switch	Machine head switch position	<ul style="list-style-type: none"> • Check if there are any problems with the connection and contacts of the connectors on the machine head. • Adjust the position of the machine head switch setting plate. 	—
Hold key	Hold mode ON/OFF	The sewing machine will not operate if hold mode is ON, so reset the hold mode.	—

brother

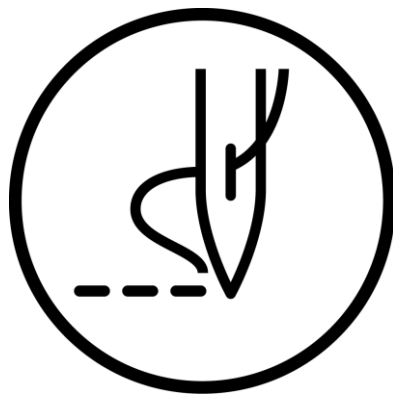

INSTRUCTION MANUAL

* Please note that the contents of this manual may differ slightly from the actual product purchased as a result of product improvements.

BROTHER INDUSTRIES, LTD. <http://www.brother.com/>
1-5, Kitajizoyama, Noda-cho, Kariya 448-0803, Japan. Phone : 81-566-95-0088

© 2022 Brother Industries, Ltd. All Rights Reserved.
This is the original instructions.

UF-8910, UF-8920
I2051664D E
2022.05. D (1)