

Please read this manual before using the machine.
Please keep this manual within easy reach for quick reference.

LCD PANEL / OPERATION PANEL

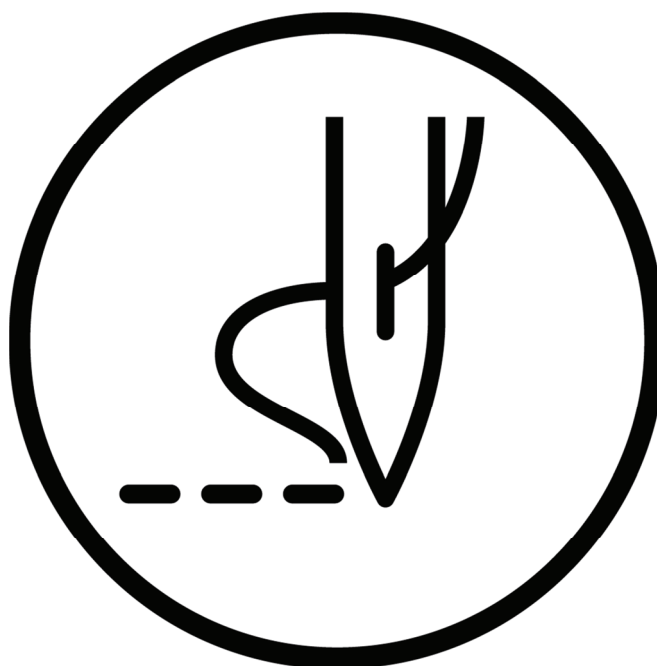

CONTENTS

1. USING THE LCD PANEL (BASIC OPERATIONS)	1
1-1. Name and function of each LCD panel item	1
1-1-1. Main names and functions	1
1-1-2. Home screen	1
1-1-3. Sewing operation screen	2
1-2. Parameter setting method	4
1-2-1. X/Y-scale, X/Y-offset	5
1-2-2. Slow start pattern	7
1-2-3. Using the lower thread counter	8
1-2-4. Using the production counter	10
1-2-5. Split number setting method	11
1-3. Copying programs	13
1-4. Checking the sewing pattern	14
1-5. Setting the work clamp lift amount	16
1-5-1. For BAS-311H/BAS-326H/BAS-326H-484/BAS-341H/BAS-342H	17
1-5-2. For BAS-360H/BAS-365H/BAS-370H/BAS-375H	19
2. USING THE LCD PANEL (ADVANCED OPERATIONS)	21
2-1. Memory switch setting method	21
2-2. List of memory switch settings	23
2-3. Using cycle programs	25
2-4. Direct selection	29
2-5. Setting the sewing screen display	30
2-6. Initialization method	32
2-7. Maintenance mode	34
3. USING STORAGE MEDIA	37
3-1. Notes on handling	37
3-2. Folder structure	37
3-3. Importing and exporting data	38
3-4. Importing items of sewing data separately	40

1. USING THE LCD PANEL (BASIC OPERATIONS)

! CAUTION



To prevent problems, do not use objects with sharp points to operate the LCD panel.

1-1. Name and function of each LCD panel item

1-1-1. Main names and functions

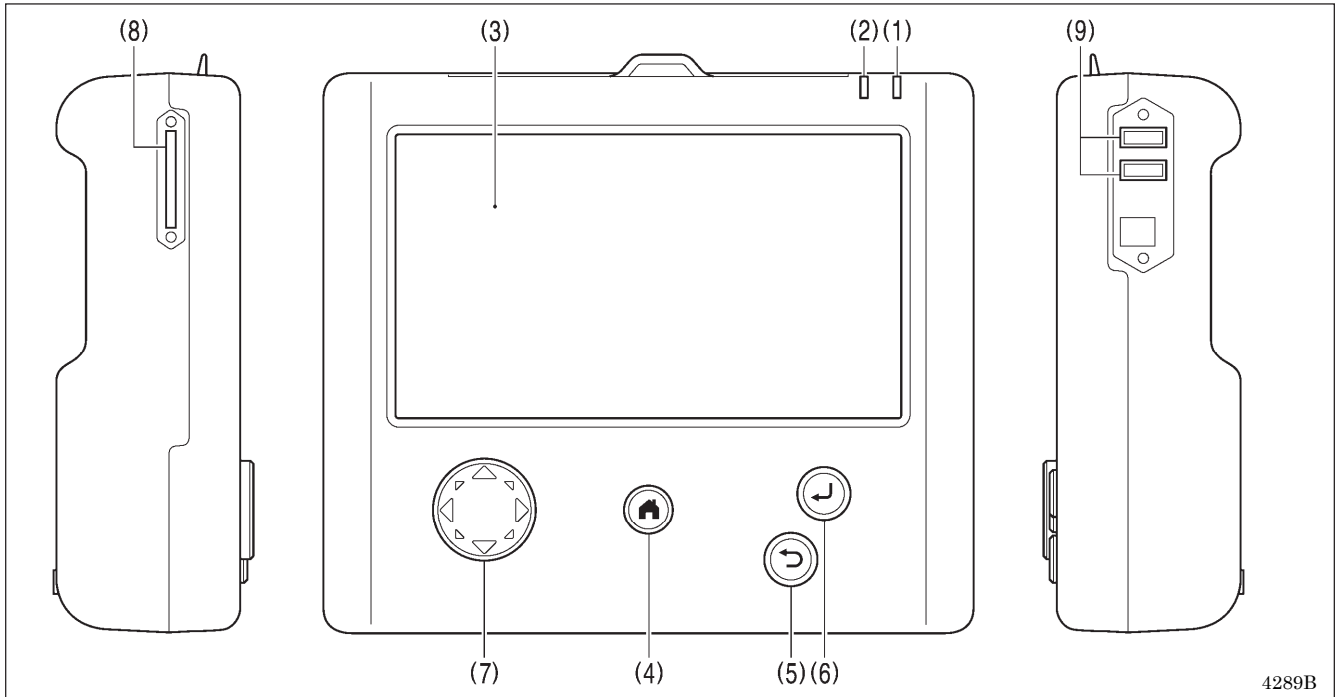

4289B

(1) Power indicator	Illuminates when the power is turned on.
(2) Caution indicator	Illuminates when an error occurs.
(3) LCD/touch panel	This displays messages and touch keys (icons).
(4) HOME key	This key is used to return to the home screen.
(5) BACK key	This key is used for operations such as returning to the previous step and canceling settings.
(6) ENTER key	This key is used for operations such as confirming settings.
(7) JOG key	This key is used when programming sewing data.
(8) SD card slot	Insert an SD card.
(9) USB port×2	Connect USB media or other device.

1-1-2. Home screen

Press the HOME key to display the home screen.

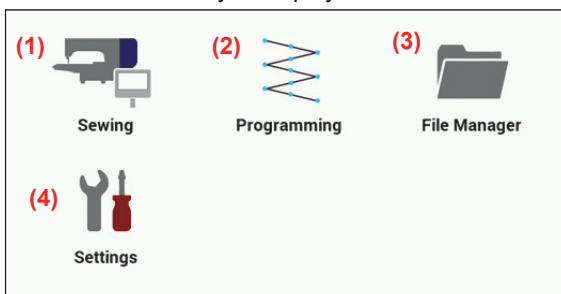

(1) Sewing key	Touch to switch to the sewing operation screen.
(2) Programming key	Touch to switch to the programming screen.
(3) File Manager key	Touch to switch to the file manager screen.
(4) Settings key	Touch to switch to the setting menu screen.

1. USING THE LCD PANEL (BASIC OPERATIONS)

1-1-3. Sewing operation screen

- When the power is turned on while the LCD panel is connected to the sewing machine, this screen is displayed automatically.
- If any other screen is being displayed, touch the sewing key in the home screen to display this screen.

[For BAS-311HN, BAS-326H, BAS-326H-484, BAS-341H and BAS-342H]

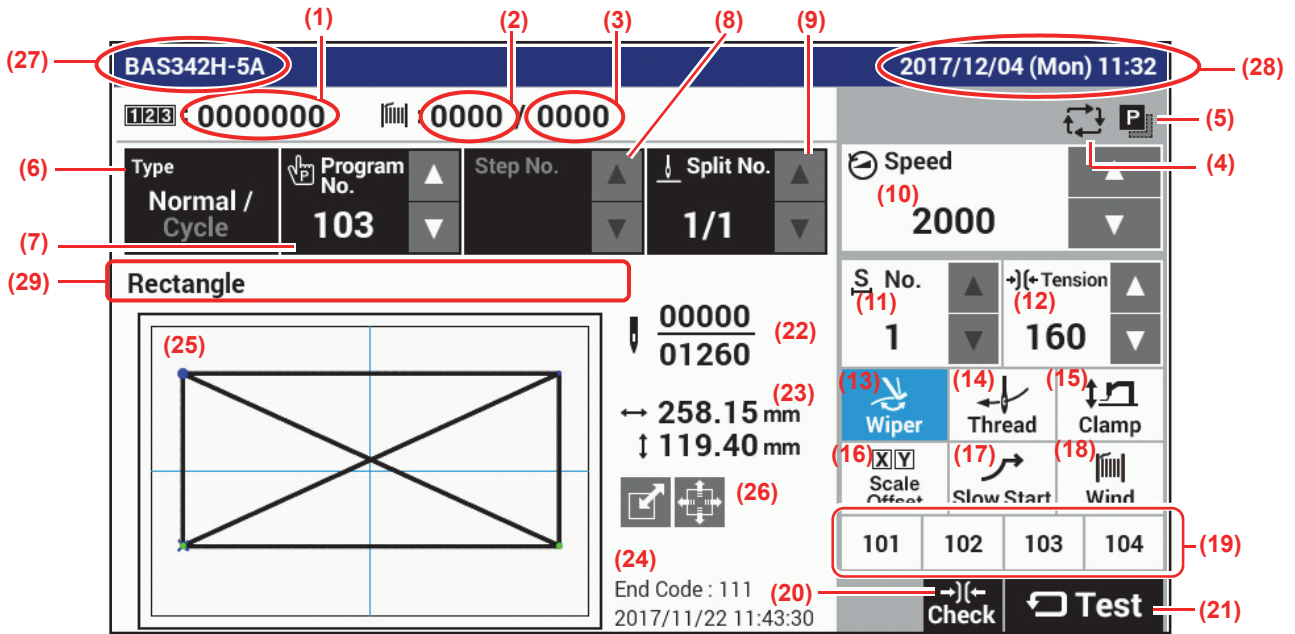

[For BAS-360H, BAS-365H, BAS-370H and BAS-375H]

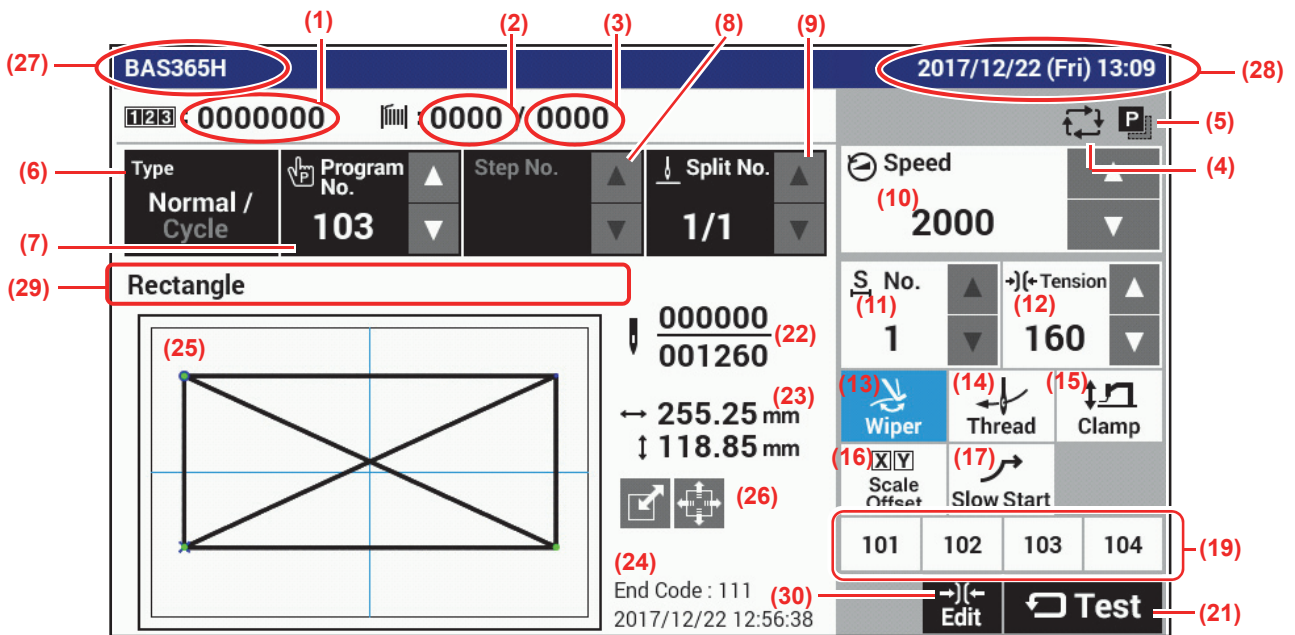

(1) Production counter key	This shows the production counter value. If you keep pressing this key, the display switches to the setting menu screen.
(2) Lower thread counter key	This shows the lower thread counter value. If you keep pressing this key, the display switches to the setting menu screen.
(3) Lower thread setting key	Displays the lower thread setting value. If you keep pressing this key, the display switches to the setting menu screen.
(4) Cycle program key	Touch to switch to the cycle program editing screen.
(5) Copy key	Touch to switch to the sewing program copying screen.
(6) Type key	Touch to select the program type.
(7) Program No. keys	Touch to display/select the current program number.

1. USING THE LCD PANEL (BASIC OPERATIONS)

(8) Step No. keys	Touch to display/select the current step number.
(9) Split No. keys	Touch to display/select the current split number.
(10) Speed keys	Touch to display/select the sewing speed.
(11) Section No. keys	Touch to display/select the section number for the digital tension. These are not displayed when digital tension is not being used.
(12) Tension keys	Touch to display/select the digital tension value. These are not displayed when digital tension is not being used.
(13) Wiper key	Touch to switch the thread wiper on/off.
(14) Thread key	Touch to switch to the threading screen.
(15) Clamp key	Touch to switch to the Adjust Clamp Height setting screen.
(16) Scale Offset key	Touch to switch to the Scale/Offset setting screen.
(17) Slow Start key	Touch to switch to the Slow Start setting screen.
(18) Wind key	Touch to switch to the thread winding screen. This is not displayed for the BAS-360H, BAS-365H, BAS-370H and BAS-375H.
(19) Direct selection keys	You can register normal/cycle program numbers into each of these keys. When you keep pressing a key, the program assigned to that key is selected.
(20) Tension operation check key	Touch to switch to the tension operation check mode. This is not displayed when digital tension is not being used.
(21) Test key	Touch to switch to test mode.
(22) Current stitch number / Total number of stitches	Shows the current stitch number and the total number of stitches.
(23) Sewing area size	Shows the size of the sewing data area.
(24) Sewing data information	Shows information about the sewing data.
(25) Preview	Shows a preview of the sewing data.
(26) Scale/Offset key	This is displayed when the Scale/Offset setting values have been changed from the default setting values. Touch the key to display the setting value.
(27) Model name	Shows the model name and specifications.
(28) Date and time	Shows the current date and time.
(29) Comments	Shows comments about the sewing data.
(30) Tension editing check key	Touch to switch to digital tension editing mode. This is not displayed when digital tension is not being used.

1-2. Parameter setting method

Parameter settings are made at the sewing operation screen.

* For details on the sewing data reading method, refer to "3. Using storage media".

* For details on memory switch setting methods, refer to "2-1. Memory switch setting method".

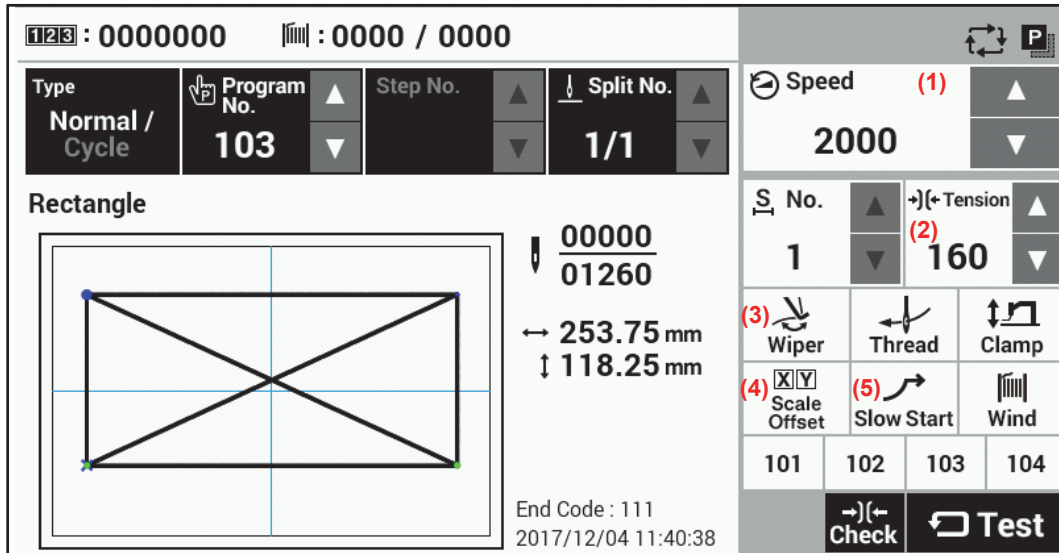

Sewing speed

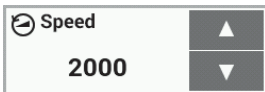

Use the Speed Δ and ∇ keys (1) to make the setting.

- Setting range: 400 sti/min to corresponding value in the table below
100 sti/min units Initial value: 2,000 sti/min

Table: Maximum sewing speed for each model

Models other than those below	2800 sti/min
BAS-326H-484	2200 sti/min
BAS-360H/BAS-365H	2700 sti/min
BAS-370H/BAS-375H	2500 sti/min

Digital tension



Touch the Tension Δ or ∇ key (2) to change the tension value.

- Setting range: 0 to 300 or 0 to 500 (BAS-360H, BAS-365H, BAS-370H and BAS-375H)
Initial value: For -3 specifications, 100 For -5 and -7 specifications, 160

Thread wiping



Touch the Wiper key (3) to turn the wiper on or off. (The initial value varies for each model and specification.)
When the setting is on, the key is displayed in blue.

1-2-1. X/Y-scale, X/Y-offset



Touch the Scale Offset key (4) in the sewing operation screen to display the X/Y-scale and X/Y-offset setting screen.

Use when you would like to enlarge, reduce or move the pattern without changing the sewing data.

* When memory switch no. 400 is set to ON, the X-scale, Y-scale, sewing speed and work clamp height can be recorded separately for each program number.

[X/Y-scale and X/Y-offset screen]

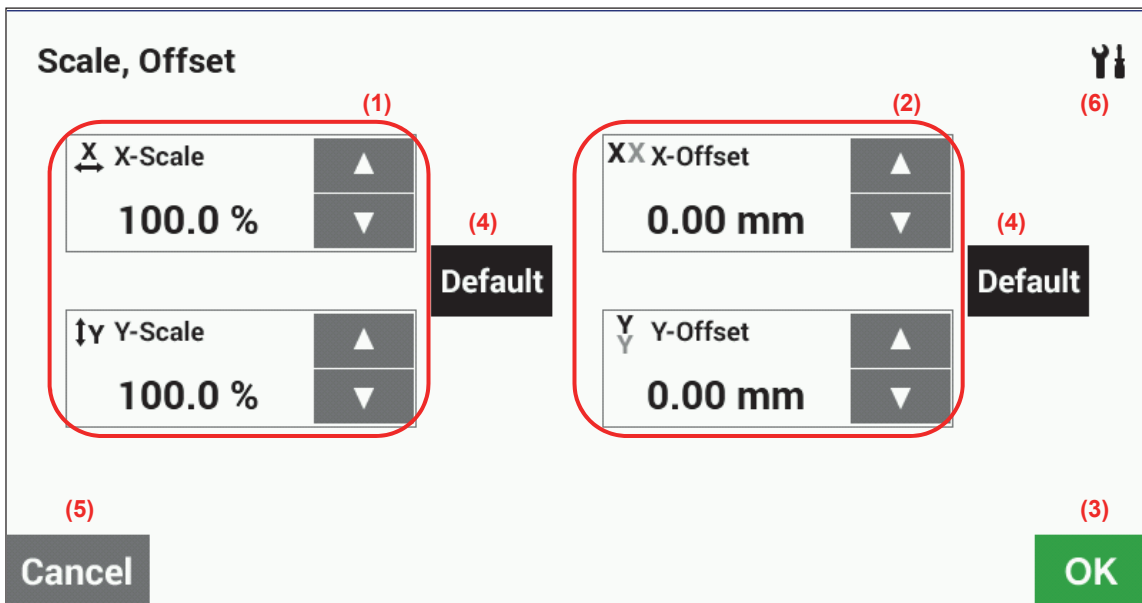

(1) X/Y-scale (X-Scale, Y-Scale)	Limited by available sewing area. Setting range: 0 to 400%, 0.1% units, initial value: 100%
(2) Offset (X-Offset, Y-Offset)	When activating the offset, first carry out home position detection(*). Setting range: 0 to 300 mm, 0.05 mm units Initial value: 0 mm
(3) OK key	Touch to confirm the setting and return the display to the previous screen.
(4) Default key	Touch to return the setting to the initial value.
(5) Cancel key	Touch to return to the previous screen without changing the setting.
(6) Setting key	Touch to display the screen for setting the center point for scaling and the display units (% or mm).

* When the foot switch is depressed to the 2nd step, home position detection is carried out.

(If using a two-pedal foot switch, lower the work clamp before depressing the start switch.

For the hand start switch for the BAS-360H and BAS-365H, use the right switch to lower the feed plate lock cylinder and the work clamp, and then press the right and left switches at the same time. For the BAS-370H and BAS-375H, press the right switch and the left switch at the same time to lower the feed plate lock cylinder and the needle bar base, and then press the right and left switches at the same time.)

1. USING THE LCD PANEL (BASIC OPERATIONS)

[Scale setting screen]

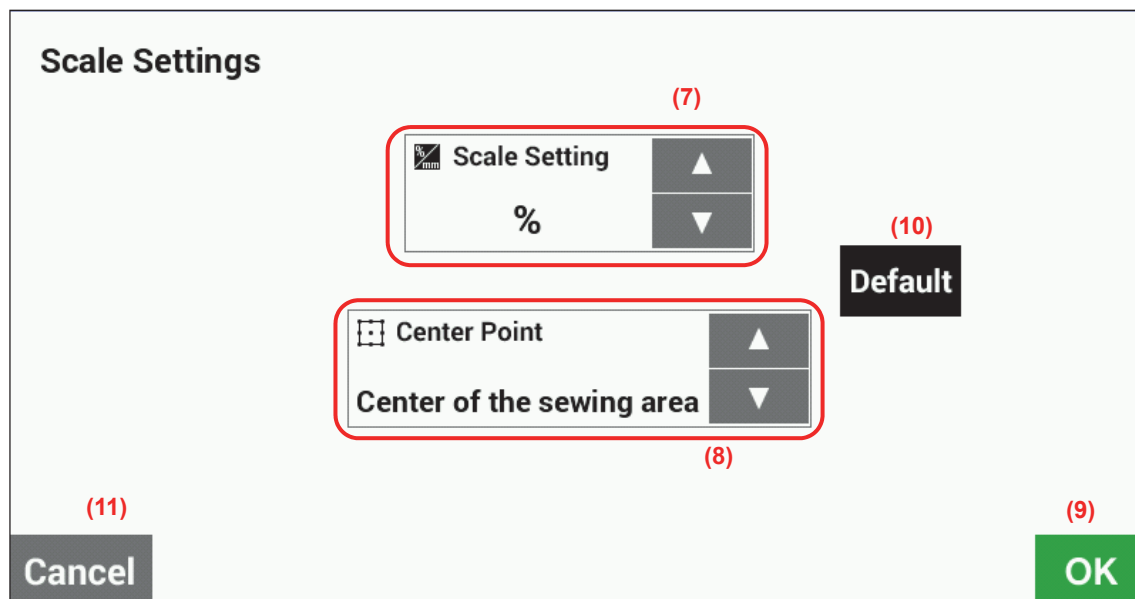

(7) Scale setting units	Touch to change the scaling units. Setting range: %, mm, initial value: %
(8) Scaling center point	Touch to change the scaling center point. Setting range: Sewing frame center position, sewing start position, center of pattern, forward center of pattern, rear center of pattern, rear-left corner of sewing area, front-left corner of sewing area, rear-right corner of sewing area, front-right corner of sewing area Initial value: Center of sewing frame
(9) OK key	Touch to confirm the setting and return the display to the previous screen.
(10) Default key	Touch to return the setting to the initial value.
(11) Cancel key	Touch to return to the previous screen without changing the setting.

1-2-2. Slow start pattern



Set memory switch No. 100 to ON and then touch the Slow Start key (5) in the sewing operation screen to display the slow start setting screen.

This is used to stop the thread from pulling out at the sewing start, and at times when skipped stitches might easily occur.

* When memory switch no. 400 is set to ON, slow start patterns can be recorded separately for each program number.

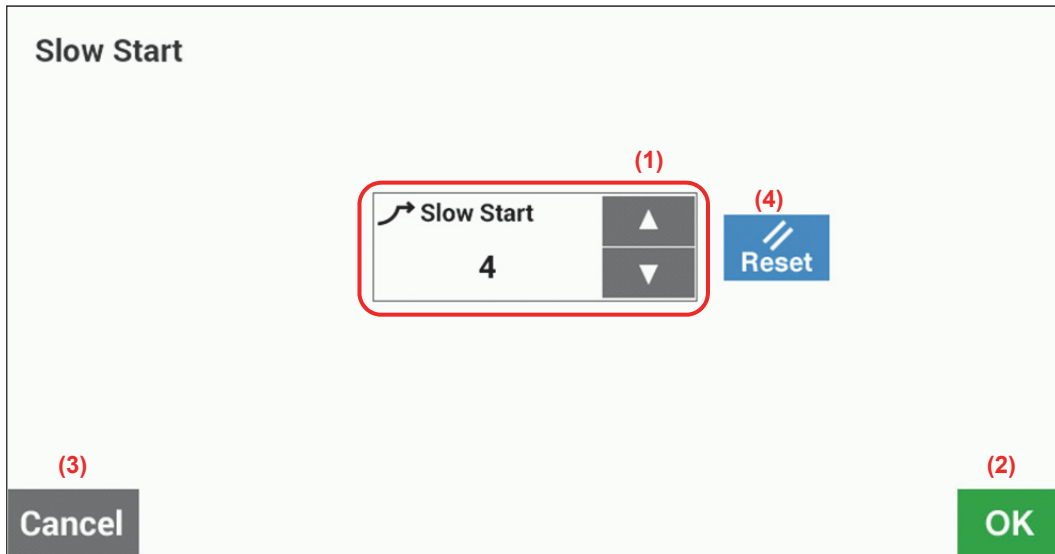

Slow Start (1)	Touch the Δ or ∇ key to adjust the starting-up speed at the sewing start. * The smaller the number, the slower the start. * Refer to the following table for the speed setting values.
OK key (2)	Touch to confirm the setting value and return to the sewing operation screen.
Cancel key (3)	Touch to return to the sewing operation screen without changing the setting value.
Reset key (4)	Touch to return the value to the value which was first displayed when you switched to the setting screen.

Table Setting values and starting-up speeds

	Lo	1	2	3	4	5	6	7	8	9
Sewing speed for 1st stitch		200	200	300	400	400	400	400	600	800
Sewing speed for 2nd stitch		200	300	400	400	500	600	800	1000	1200
Sewing speed for 3rd stitch		300	400	500	600	800	1000	1200	1600	*1
Sewing speed for 4th stitch		500	600	700	900	1200	1400	*1	*1	*1

*1 Sewing will be carried out at the sewing speed which is set by the "Sewing speed" parameter.

1. USING THE LCD PANEL (BASIC OPERATIONS)

1-2-3. Using the lower thread counter

If you use the lower thread counter to set the number of articles which can be sewn with the amount of lower thread available, you can stop the lower thread running out in the middle of sewing a pattern.

<Setting the lower thread setting value>

If you keep pressing the lower thread setting key (1) in the sewing operation screen, the screen will switch to the input screen for the lower thread setting value.

[Sewing operation screen]

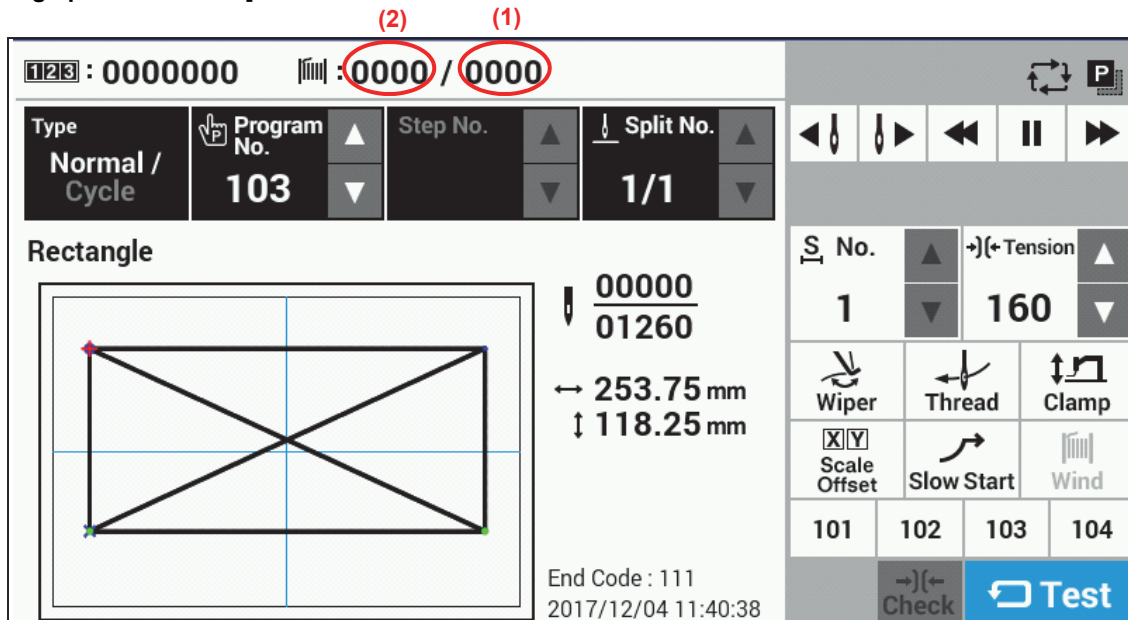

Enter the value and then touch the OK key (3) to confirm the value.

When the lower thread setting value has been set, the same value will appear as the lower thread counter value (2).

- If the value is set to "0000", the lower thread counter will not operate.

The lower thread setting value can be set to "0"- "9999".

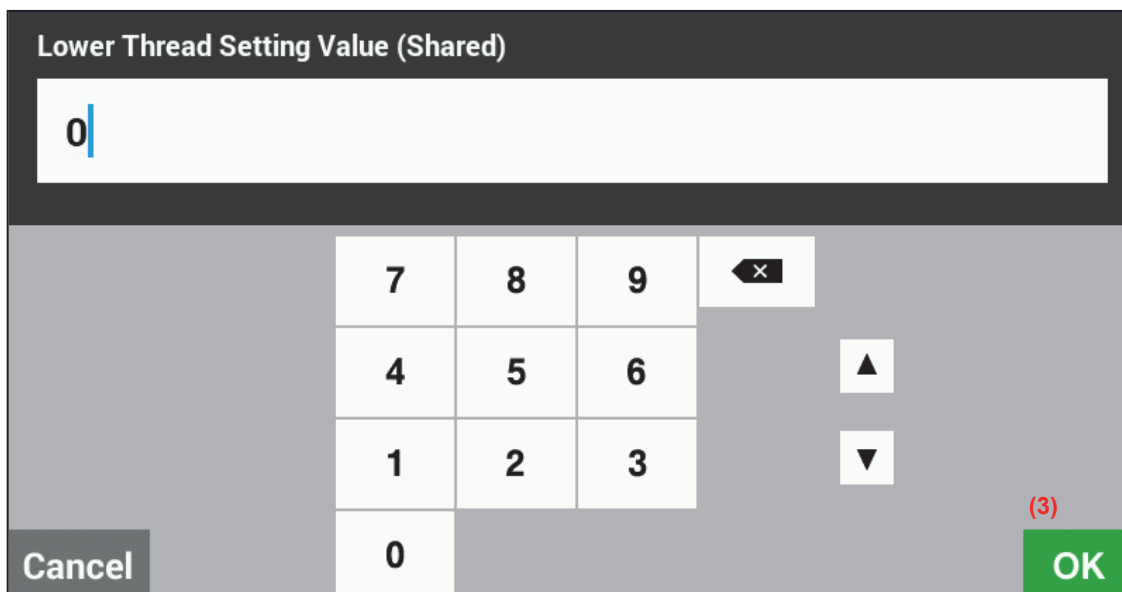

<Setting the lower thread counter value>

If you keep pressing the lower thread counter key (2) in the sewing operation screen, the screen will switch to the input screen for the lower thread counter value.

Enter the value and then touch the OK key (5) to confirm the value.

Touch the Reset key (4) to set the lower thread setting value as the lower thread counter value.

The lower thread counter value can be set from "0" to the lower thread setting value.

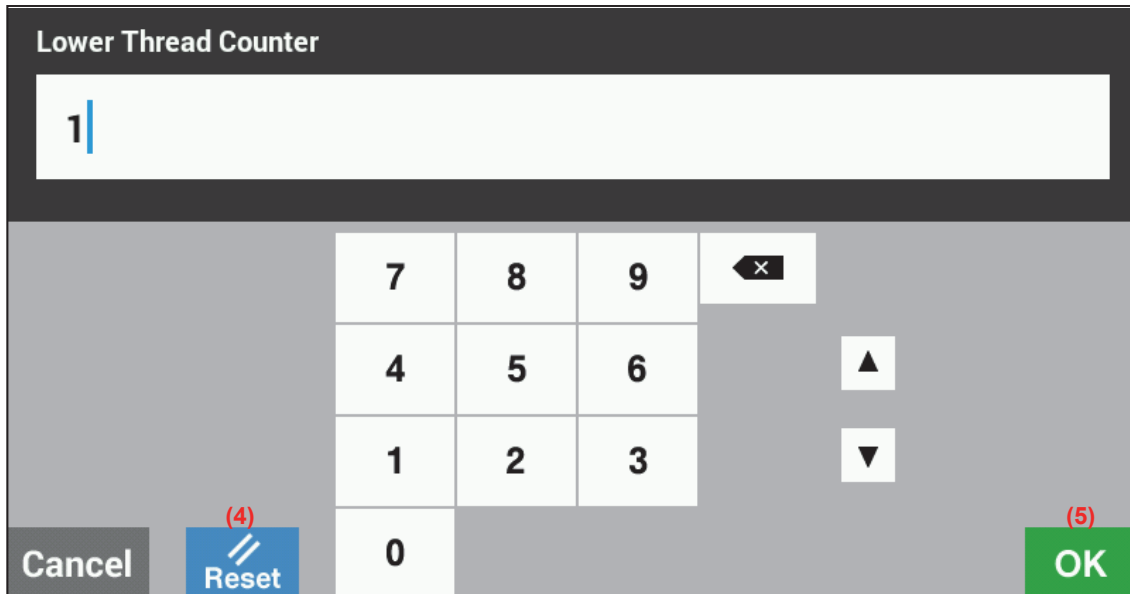
**<Lower thread counter operation>**

If the initial value for the lower thread counter is set to a value other than "0", the lower thread counter will operate.

The counter value decreases by 1 each time sewing of an item is completed, and when it reaches "0", a message screen is displayed and the buzzer sounds.

When this happens, the sewing machine cannot be operated.

Touch the Reset key (6) to return the lower thread counter value to the initial value, and then sewing will be possible again.

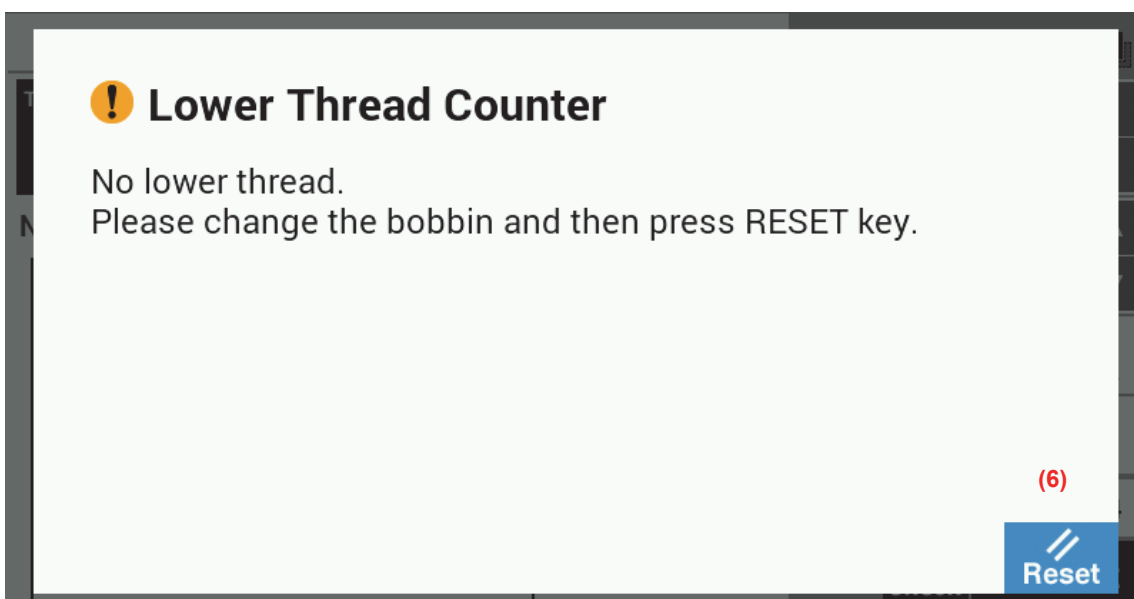
[Message screen]

1. USING THE LCD PANEL (BASIC OPERATIONS)

1-2-4. Using the production counter

<Setting the counter value>

If you keep pressing the production counter key (1) in the sewing operation screen, the screen will switch to the input screen for the production counter.

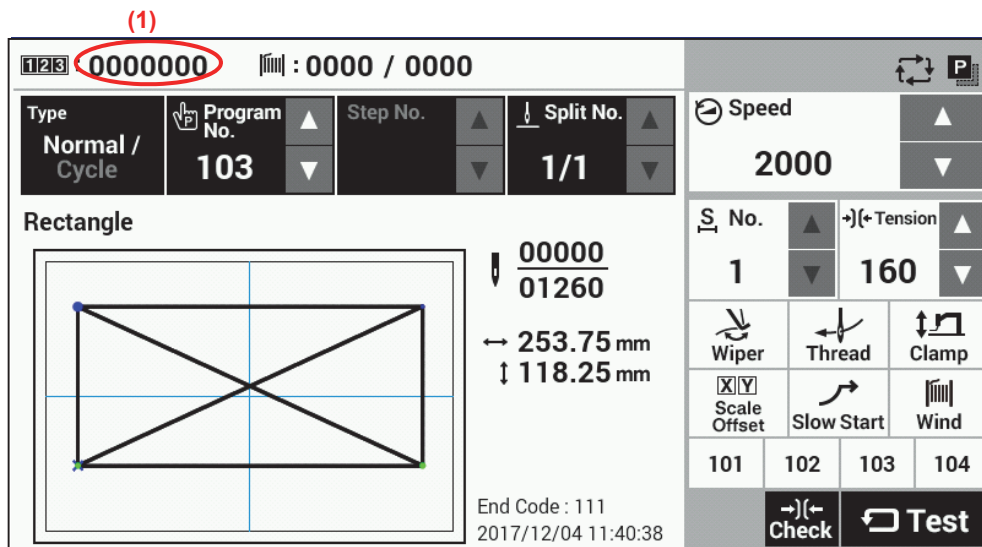

The counter value can be set to a value from "0" to "9999999".

If you would like to return the value to "0", touch the Reset key (2) and then touch the OK key (3).

After doing this, the display will return to the sewing operation screen.

Touch the Cancel key (4) to return to the sewing operation screen without changing the value.

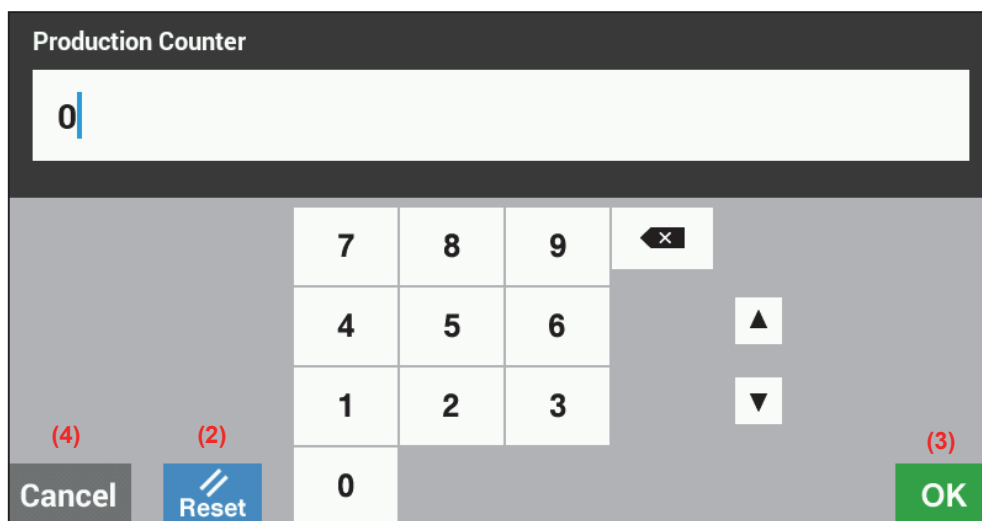

<Production counter operation>

The production counter always operates, and it increases by 1 each time sewing of an item is completed.

1-2-5. Split number setting method

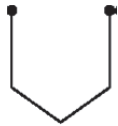

Pattern 1



Pattern 2

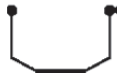

Pattern 3

4964Q

If split codes (sewing interrupt data) exist in one program, the number which indicates the pattern which has been divided by the split codes is called the split number.

Pattern 1: Split No. 1
 Pattern 2: Split No. 2
 Pattern 3: Split No. 3

[Sewing operation screen]

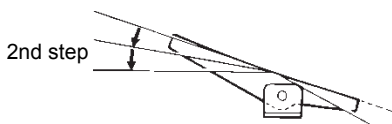
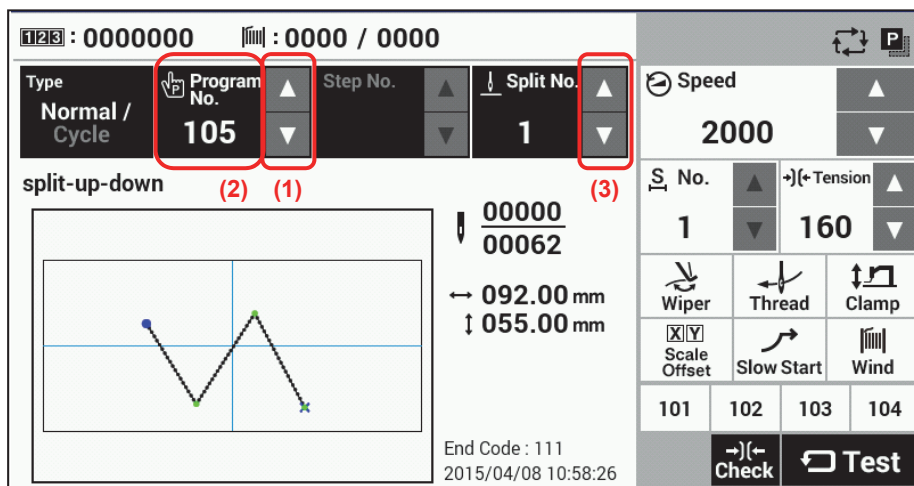

2nd step

4441Q

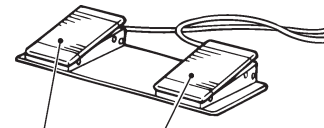

Work clamp switch (2-step)

Start switch

4923Q

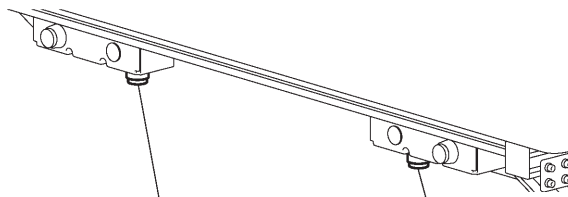

Left switch

Right switch

4169B

1. Touch the "Program No." Δ or ∇ key (1) to select the program number which includes the split code.
 - The "Program No." value (2) will flash.
2. Depress the foot switch to the 2nd step to carry out home position detection.

(If using a two-pedal foot switch, lower the work clamp before depressing the start switch. For the hand start switch for the BAS-360H and BAS-365H, use the right switch to lower the feed plate lock cylinder and the work clamp, and then press the right and left switches at the same time. For the BAS-370H and BAS-375H, press the right switch and the left switch at the same time to lower the feed plate lock cylinder and the needle bar base, and then press the right and left switches at the same time.)

* The feed mechanism will move to the home position and the program number will be confirmed. (The "Program No." setting (2) will stop flashing and illuminate steadily.)
3. Use the "Split No." Δ or ∇ key (3) to select the split number.

1. USING THE LCD PANEL (BASIC OPERATIONS)

The setting for memory switch No. 403 lets you select the split mode.

[Continuous split]

Memory switch No. 403 = 0

- Sewing is carried out each time in the order of steps 1 → 2 → 3 → 1 (for example, if there are two split codes).

[Independent split]

Memory switch No. 403 = 1

- The pattern for the displayed split number is sewn independently.

1-3. Copying programs

[Sewing operation screen]

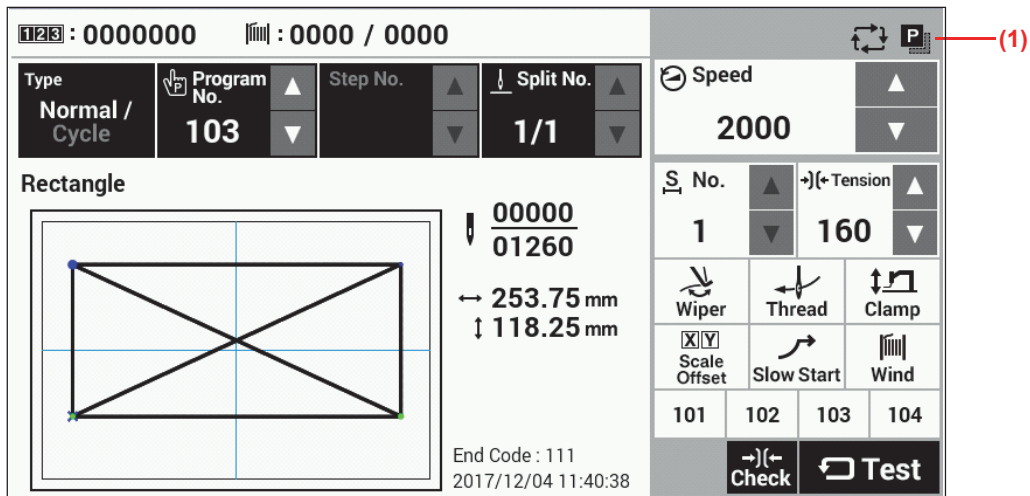

Touch the Copy key (1) to switch to the program copy screen.

[Program copy screen]

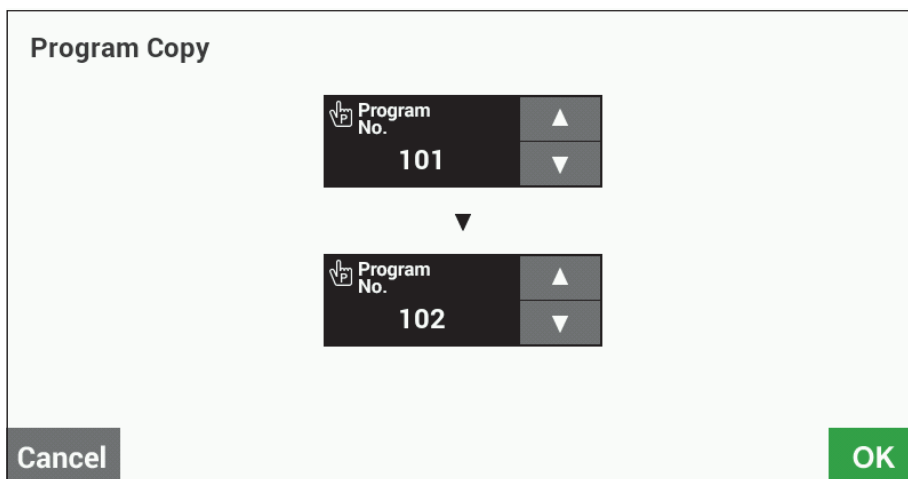

Select the copy source program No. and the copy destination program No.

Touch the OK key to carry out copying. After copying, the display will return to the previous screen.

Touch the Cancel key to return to the previous screen without copying.

* The number which is selected as the copy destination program number will flash only if sewing data already exists in a program assigned to that number.

1-4. Checking the sewing pattern

Use test feed mode to operate the feed mechanism in order to check the needle movement.
Check that the needle hole does not come out from the frame of the work clamp.

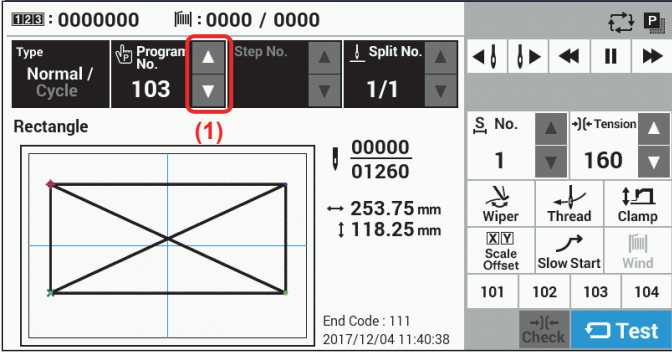
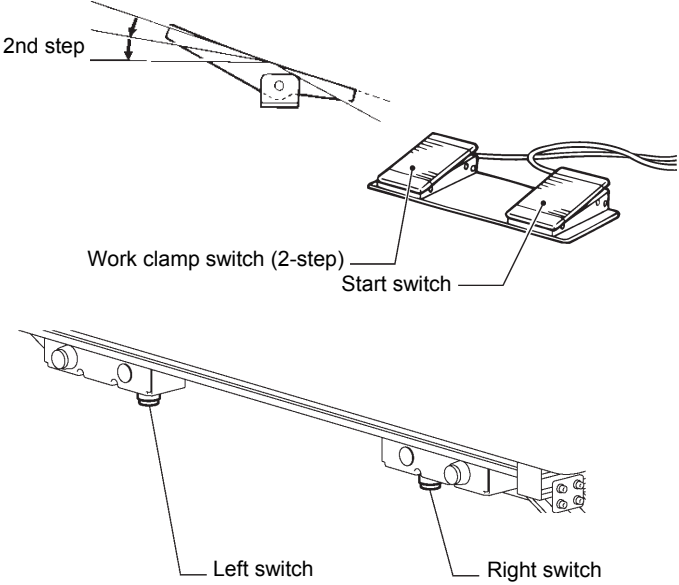
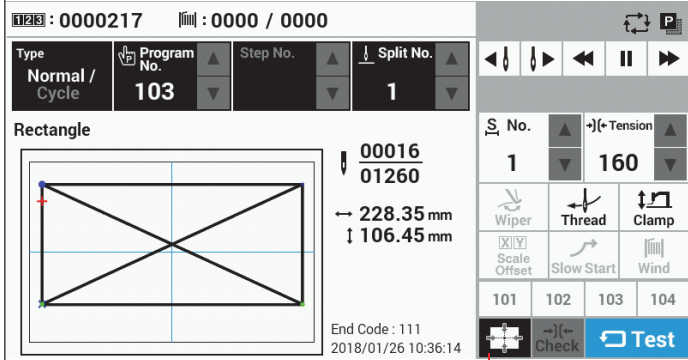
1	 <p>The Test key is displayed in blue.</p> <p>[Sewing operation screen]</p> 	<ol style="list-style-type: none"> 1. Touch the Test key at the sewing operation screen. 2. Press the Δ or ∇ key (1) to set the program number that you would like to check.
2	<p>Continuous test feed</p> 	<ol style="list-style-type: none"> 1. Depress the foot switch to the 2nd step (for a 2-pedal foot switch, lower the work clamp and then depress the start switch. For the hand start switch for the BAS-360H and BAS-365H, press the right switch to lower the feed plate lock cylinder and the work clamp, and then press the right and left switches at the same time. For the BAS-370H and BAS-375H, press the right switch and the left switch at the same time to lower the feed plate lock cylinder and the needle bar base, and then press the right and left switches at the same time.) Furthermore, if you touch the continuous feed key (2), the feed mechanism will start moving continuously one stitch at a time. (The current stitch number in the stitch number display will increase by 1 each time.) 2. When the feed reaches the end of the pattern, it stops. <ul style="list-style-type: none"> • If you would like to stop the feeding operation, touch the continuous feed stop key (3). • If you touch the continuous feed key (4), the feed mechanism will start moving continuously in the direction of the sewing start position one stitch at a time. • Touch the Move to sewing start key (5) to return to the sewing start.
		

4441Q
4923Q
4169B

3

[For BAS-311HN, BAS-326H, BAS-326H-484, BAS-341H and BAS-342H]

Single stitch check

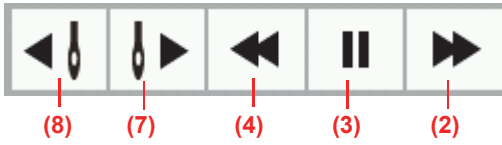

[For BAS-360H, BAS-365H, BAS-370H and BAS-375H]

Checking the specified number of stitches

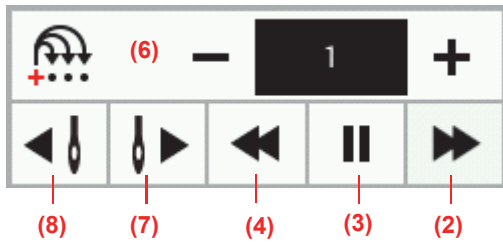

1. If you touch the stitch forward key (7) or the stitch back key (8), the feed mechanism will move by the specified number of stitches.

- Touch the Move to sewing start key (5) to return to the sewing start.

2. At the specified number of stitches, touch the + or - key (6) to specify the number of stitches to move.

3. If you touch the stitch forward key (7) or the stitch back key (8), the feed mechanism will move by the specified number of stitches

- If you would like to stop the feeding operation, touch the continuous feed stop key (3).

- Touch the Move to sewing start key (5) to return to the sewing start.

1-5. Setting the work clamp lift amount

The settings for the work clamp and intermittent presser foot lift amounts can be changed at the sewing operation screen.

* For pneumatic work clamp specifications, only intermittent presser foot height setting mode will be available.

[Sewing operation screen]

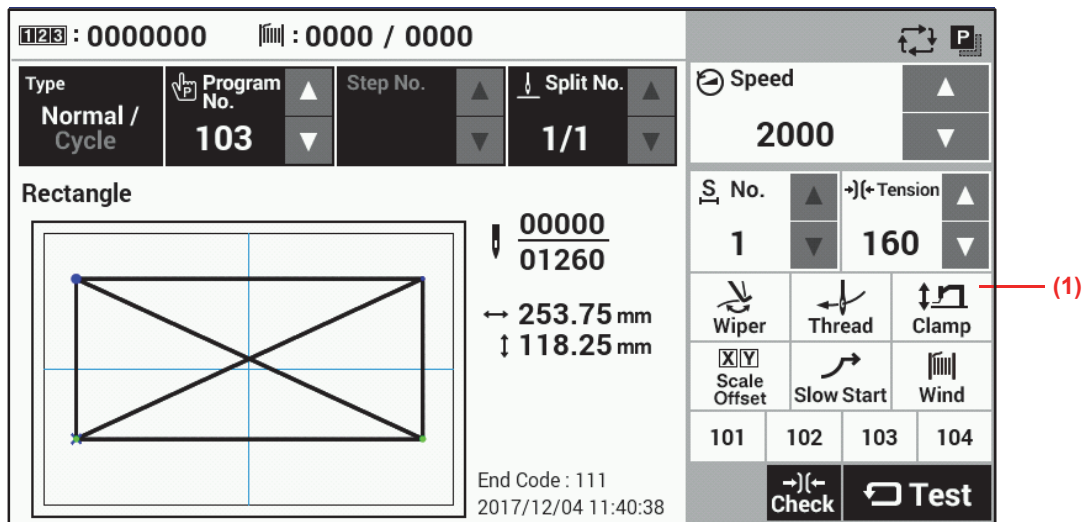

Touch the Clamp key (1) to display the Adjust Clamp Height setting screen.

1-5-1. For BAS-311H/BAS-326H/BAS-326H-484/BAS-341H/BAS-342H

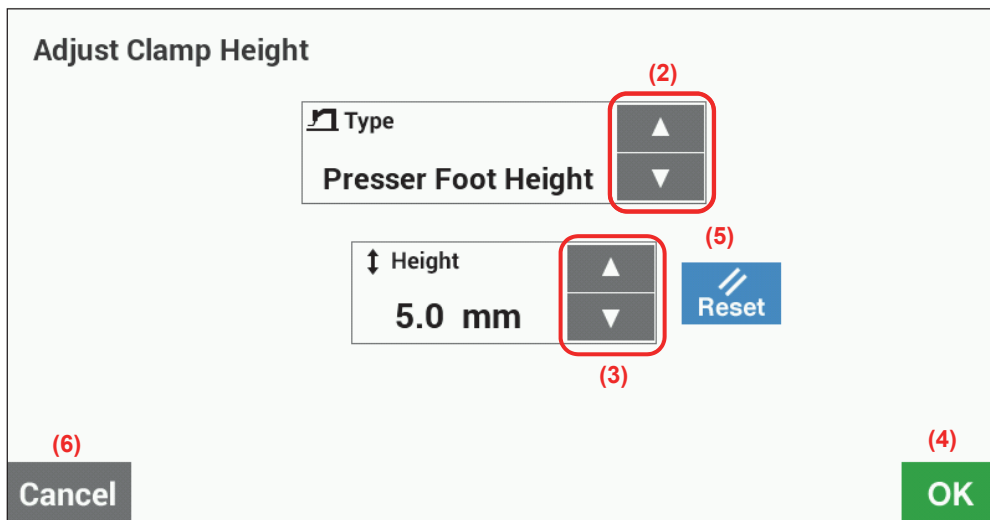

- Work clamp height setting (can only be selected for motor driven-type work clamp)
 - Use the Type keys (2) to select "Work Clamp Height".
 - If you use the Height keys (3) to change the Height value, the sewing machine's work clamp will move. (setting range: 15 - 25 initial value: 20)
 - Touch the OK key (4) to confirm, or touch the Cancel key (6) to return to the sewing operation screen without changing the setting.
 - Touch the Reset key (5) to return the value which currently appears in the display to the value which was first displayed when you switched to the setting screen. The sewing machine's work clamp will operate according to this value.
- Intermediate work clamp height setting (can only be selected for motor driven-type work clamp)

Selection is only possible when memory switch No. 003 is set to "2".

 - Use the Type keys (2) to select "Intermediate Work Clamp Height".
 - If you use the Height keys (3) to change the Height value, the sewing machine's work clamp will move. (setting range: 1 - 15 initial value: 7)
 - Touch the OK key (4) to confirm, or touch the Cancel key (6) to return to the sewing operation screen without changing the setting.
 - Touch the Reset key (5) to return the value which currently appears in the display to the value which was first displayed when you switched to the setting screen. The sewing machine's work clamp will operate according to this value.
- Intermittent presser foot height setting
 - Use the Type keys (2) to select "Intermittent Presser Foot Height".
 - If you use the Height keys (3) to change the Height value, the sewing machine's intermittent presser foot will move. (setting range: 0.0 - 10.0 initial value: 5.0)
 - Touch the OK key (4) to confirm, or touch the Cancel key (6) to return to the sewing operation screen without changing the setting.
 - Touch the Reset key (5) to return the value which currently appears in the display to the value which was first displayed when you switched to the setting screen. The sewing machine's intermittent presser foot will operate according to this value.

1. USING THE LCD PANEL (BASIC OPERATIONS)

NOTE:

When setting the work clamp height and the intermediate work clamp height, check that slider (1) is touching the work clamp lifter plate assembly (2).

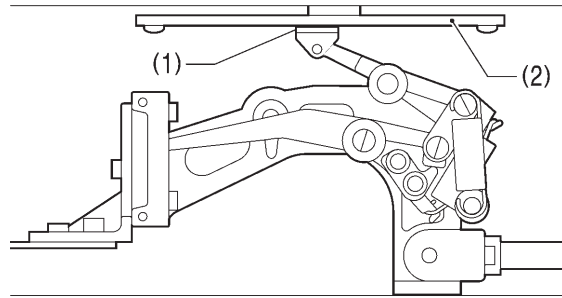

3091B

Intermittent presser foot operation

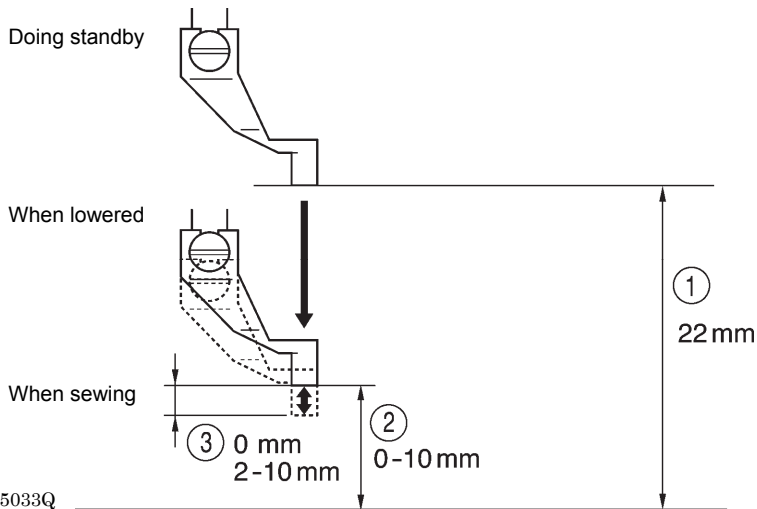

5033Q

- ① Intermittent presser foot lift amount
- ② Intermittent presser foot height stroke drop position
- ③ Intermittent presser foot stroke amount

* After the presser foot has been replaced, it will be necessary to make corrections to the intermittent stroke drop position.

Ask the place of purchase for information on the correction method.

1-5-2. For BAS-360H/BAS-365H/BAS-370H/BAS-375H

Adjust the intermittent presser foot height by setting the intermittent stroke drop position and the intermittent stroke amount.

[Stroke drop position setting]

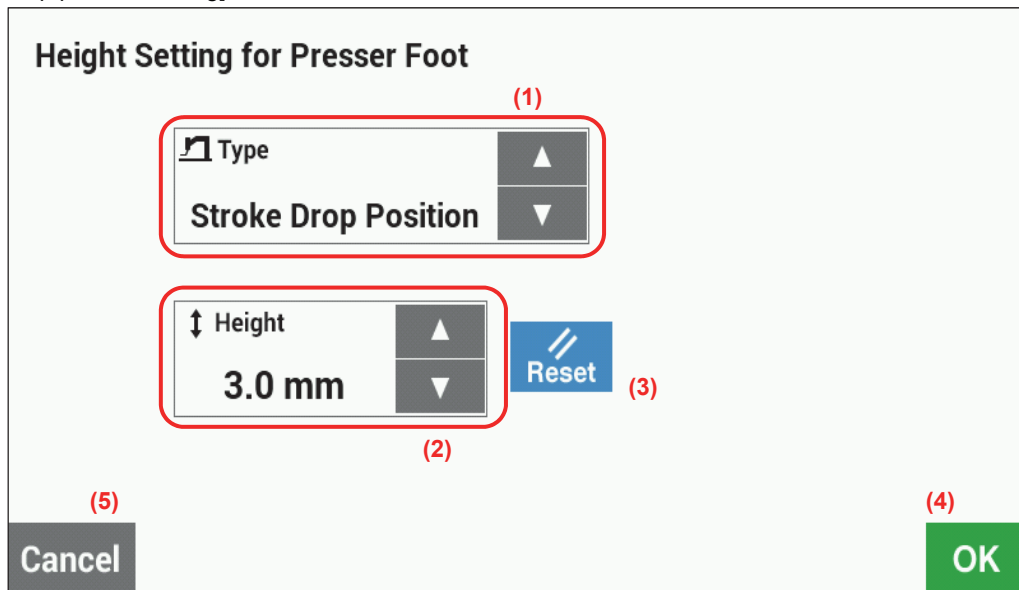

[Stroke amount setting]

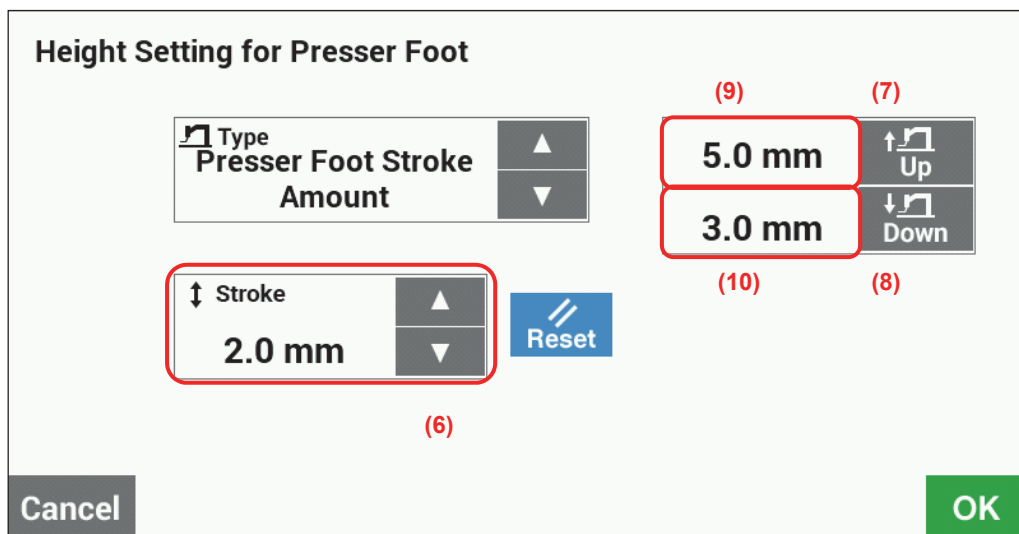

Type (1)	Touch the Δ or ∇ key to select the item to change.
Height (2)	Touch the Δ or ∇ key to change the stroke drop position. If you change the value, the sewing machine's intermittent presser foot will move. Setting range: 0.5 to 7.0 mm, 0.1 mm units, initial value: 2.0 mm
Reset key (3)	Touch to return the value which currently appears in the display to the value which was first displayed when you switched to the setting screen. The sewing machine's intermittent presser foot will move according to this value.
OK key (4)	Touch to confirm the setting value and return to the sewing operation screen.
Cancel key (5)	Touch to discard the setting value and return to the sewing operation screen.
Stroke (6)	Touch the Δ or ∇ key to change the stroke amount. If you change the value, the sewing machine's intermittent presser foot will move. Setting range: 0.0 to 10.0 mm, 0.1mm units, initial value: 3.0 mm

1. USING THE LCD PANEL (BASIC OPERATIONS)

Stroke Up key (7)	Touch to raise the intermittent presser foot. However, the key is disabled while the intermittent presser foot is rising.
Stroke Down key (8)	Touch to lower the intermittent presser foot. However, the key is disabled while the intermittent presser foot is lowering.
Intermittent presser foot height (9)	Displays the sum of the value set for the stroke drop position and the value set for the stroke amount. ("Intermittent presser foot operation" (2))
Stroke drop position (10)	Displays the value set for the stroke drop position. ("Intermittent presser foot operation" (3))

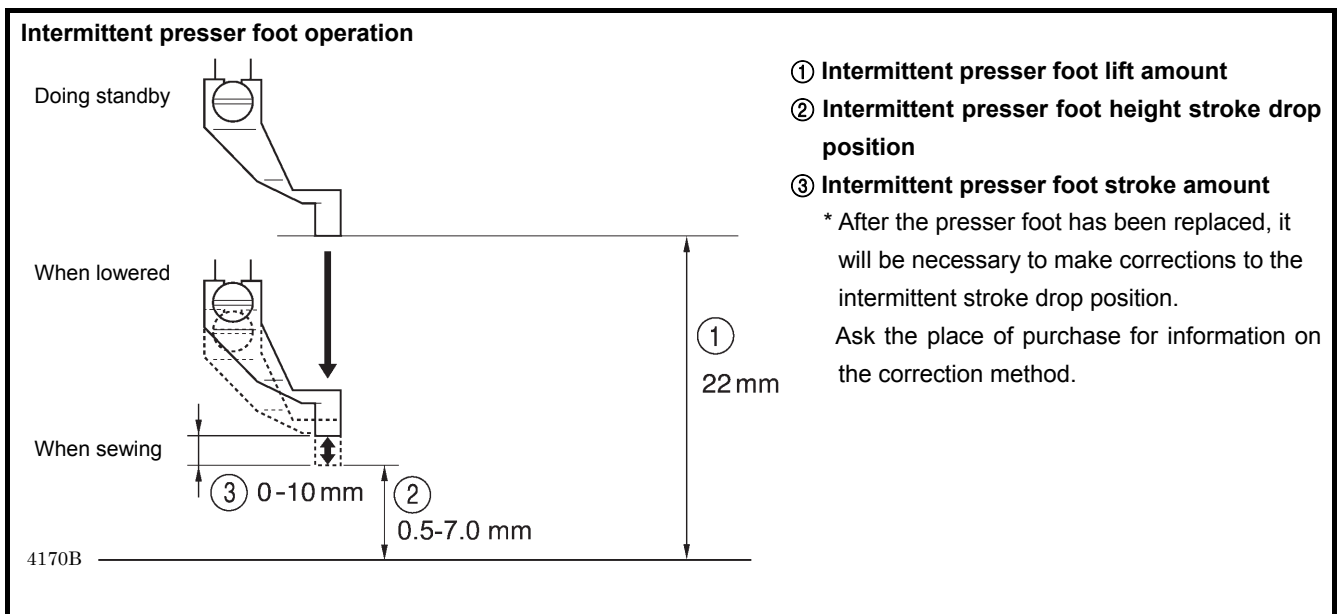

2. USING THE LCD PANEL (ADVANCED OPERATIONS)

⚠ CAUTION



To prevent problems, do not use objects with sharp points to operate the LCD panel.

2-1. Memory switch setting method

Press the HOME key to switch to the home screen.

[Home screen]

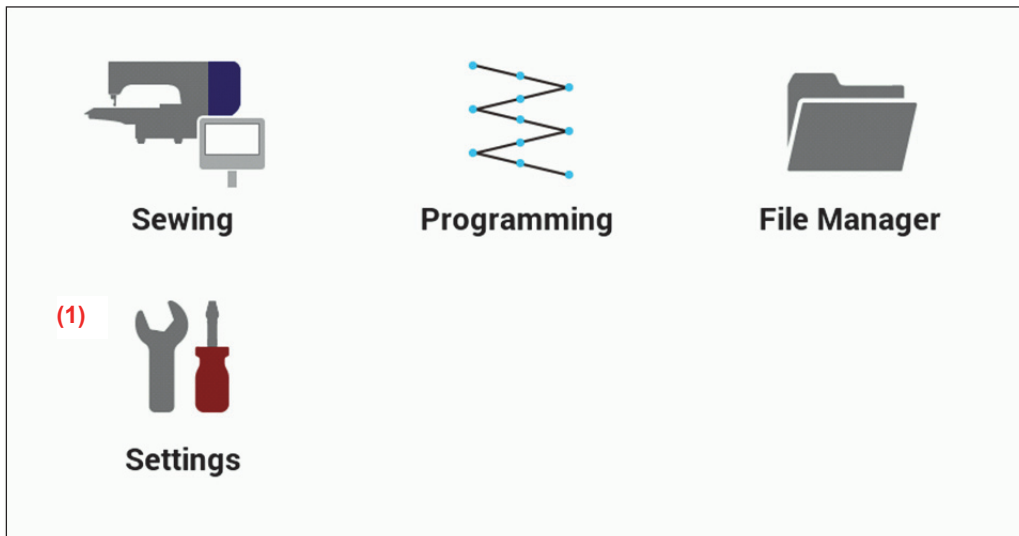

Touch the Settings key (1) to switch to the setting menu screen.

[Setting menu screen]

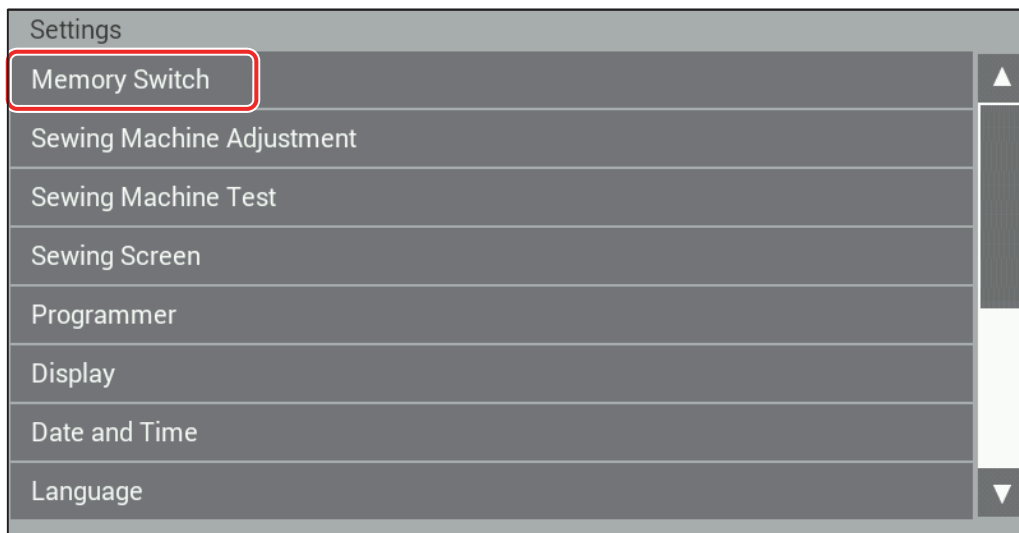

Select "Memory Switch".

2. USING THE LCD PANEL (ADVANCED OPERATIONS)

[Memory switch selection screen]

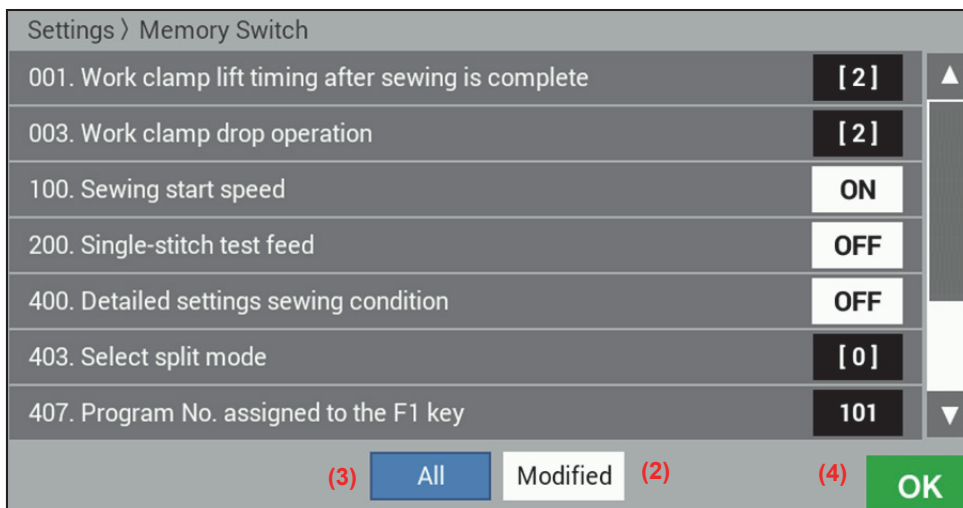

Select the number of the memory switch that you would like to change the setting for.

- When you touch the number of the memory switch you would like to change the setting for, the display will change to the memory switch editing screen.
- Touch the OK key (4) to return to the setting menu screen.
- Modified (2): This displays the numbers of memory switches that have been changed from default settings.
- All (3): This displays all memory switches.

[Memory switch editing screen]

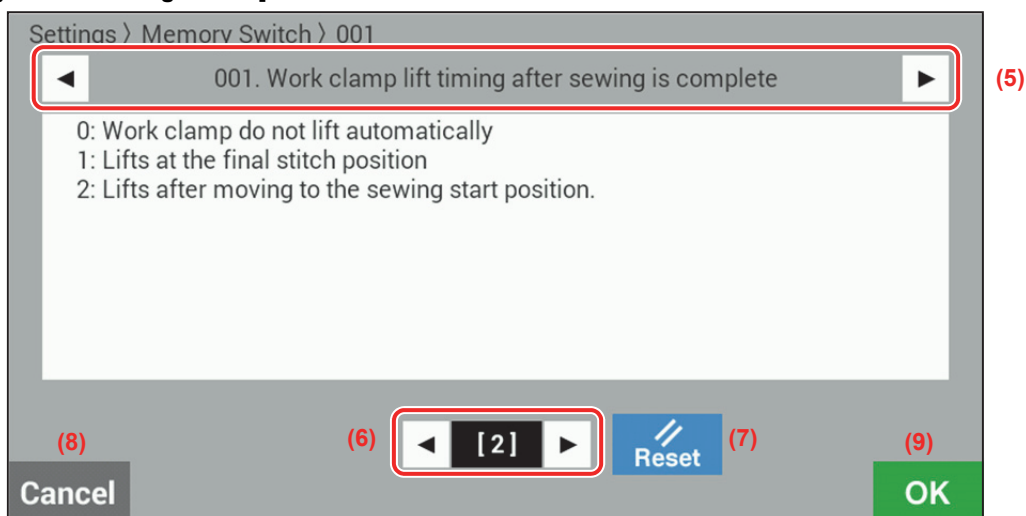

This lets you change memory switch values.

- Number (◀ ▶) keys (5): These change the memory switch number.
- Value (◀ ▶) keys (6): These change the memory switch setting value display (ON/OFF, number).
- Reset key (7): This displays the initial value.
- Cancel key (8): This returns the display to the memory switch selection screen without confirming the value.
- OK key (9): This confirms the value and then returns the display to the memory switch selection screen.

2-2. List of memory switch settings

No.	Function name		
	Setting range	Setting details	Initial value
001	Work clamp lift timing after sewing is completed		
	0	Work clamp is not raised automatically.	2
	1	Work clamp is raised at the final stitch position.	
	2	Work clamp is raised after moving to the home position.	
002	Work clamps lowering operation (Models other than pneumatic work clamp specifications/BAS341H/BAS342H) (*2)		
	0	Left and right work clamps are lowered at the same time.	0
	1	Work clamps are lowered in order left > right.	
	2	Work clamps are lowered in the order right > left.	
	Work clamp lowering operation (BAS341H/BAS342H only) (*2)		
	0	Work clamp dropping in one step	0
	1	Work clamp dropping in two steps (*1)	
2	Do not use this setting.		
003	Work clamp lowering operation (Motor-driven work clamp specifications only)		
	0	Analog lowering: Work clamp is lowered in direct proportion to the pedal depression amount, and sewing starts when the pedal is fully depressed. * This operation is only possible for foot switch specifications; for two-pedal foot switch specifications, operation is the same as for a 2-step work clamp.	2
	1	1-step work clamp: Work clamp is lowered when pedal is depressed to the 1st step, and sewing starts when pedal is depressed to the 2nd step.	
	2	2-step work clamp: Work clamp is lowered to intermediate height when pedal is depressed to the 1st step, and work clamp is fully lowered and sewing starts when the pedal is depressed to the 2nd step.	
100	Slow start method		
	OFF	The sewing speed for the first 5 stitches will be in accordance with the setting for memory switch Nos. 151 to 155. (Ask the place of purchase for details on memory switch Nos. 151 to 155.)	OFF
	ON	The sewing speed for the first 4 stitches can be selected from the nine slow start patterns "1" to "9". (Refer to Slow start pattern in "1-2. Parameter setting method".) Initial value of slow start pattern: 4	
200	Single-stitch test feed		
	OFF	Test feed starts when the foot switch (start switch) is depressed, and it continues automatically until the final stitch.	OFF
	ON	Test feed starts when the foot switch (start switch) is depressed, and it moves forward by one stitch each time the switch is depressed. In addition, after test feed starts, test feed will move forward one stitch at a time when the machine pulley is turned by hand.	
400	Sewing condition detail settings		
	OFF	Parameters which are common to all programs are used.	OFF
	ON	Parameters can be set separately for each program.	
403	Split mode selection		
	0	Continuous split mode	0
	1	Single split mode	

(*1) The position of the work clamp stopper must be set.

(*2) This is not displayed for the BAS-360H, BAS-365H, BAS-370H and BAS-375H.

2. USING THE LCD PANEL (ADVANCED OPERATIONS)

No.	Function name		
	Setting range	Setting details	Initial value
407	Assignment to direct selection key 1		
	OFF	No program number is assigned to direct selection key 1.	101
	1 - 999	The program number is assigned.	
	C01 - C30	The cycle program number is assigned.	
408	Assignment to direct selection key 2		
	OFF	No program number is assigned to direct selection key 2.	102
	1 - 999	The program number is assigned.	
	C01 - C30	The cycle program number is assigned.	
409	Assignment to direct selection key 3		
	OFF	No program number is assigned to direct selection key 3.	103
	1 - 999	The program number is assigned.	
	C01 - C30	The cycle program number is assigned.	
410	Assignment to direct selection key 4		
	OFF	No program number is assigned to direct selection key 4.	104
	1 - 999	The program number is assigned.	
	C01 - C30	The cycle program number is assigned.	

2-3. Using cycle programs

Sewing patterns that have been recorded in user programs can be saved in up to 30 cycle programs.

One cycle program can contain up to a maximum of 50 steps.

When sewing the sewing patterns in a certain order, it can be useful to save them in a cycle program beforehand.

* If memory switch No. 400 is set to OFF, cycle program setting and selection cannot be carried out.

<Registration method>

This describes the procedure using an example in which program number 106 is registered as the 1st step, program number 200 is registered as the 2nd step and program number 252 is registered as the 3rd step of cycle program number C01.

1. Touch the cycle program key in the sewing operation screen to switch to the cycle program editing screen.
 - * To edit a cycle program which has already been created, first select the desired cycle program number and then touch the cycle program key.

[Sewing operation screen]

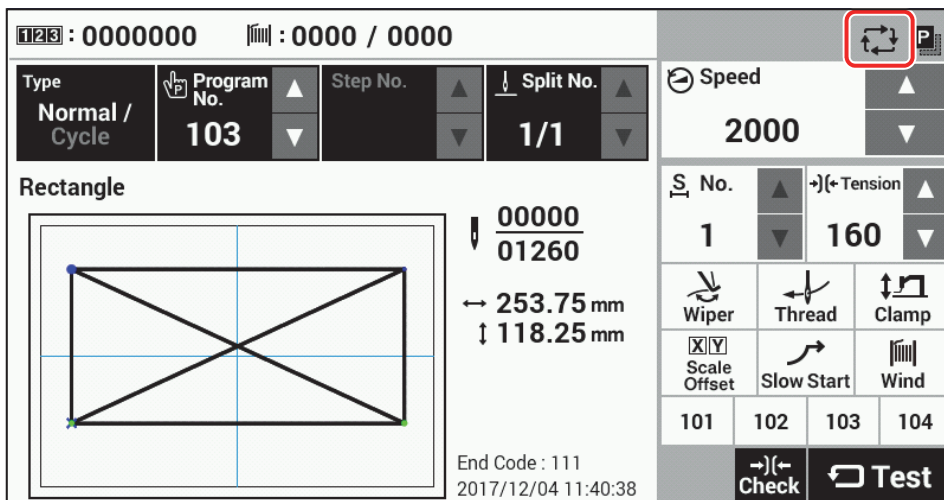

2. Touch the add step key (1) in the cycle program editing screen to switch to the add step screen.

[Cycle program editing screen]

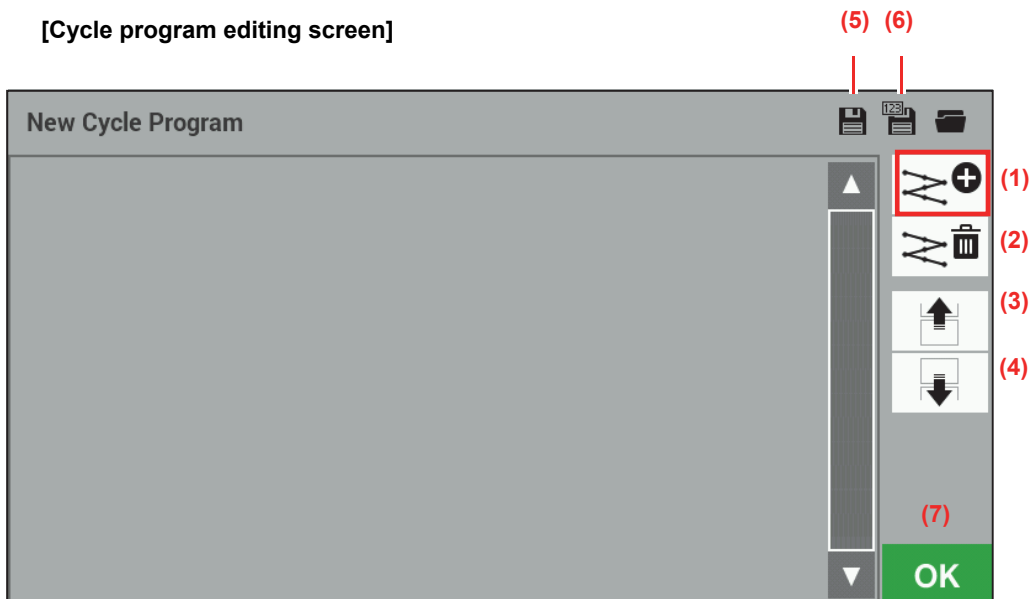

2. USING THE LCD PANEL (ADVANCED OPERATIONS)

Descriptions of keys

(1)	Add step	Switches to the screen for selecting a program to add.
(2)	Delete step	Deletes the program which is currently selected.
(3)	Move step (forward)	Moves the currently-selected program one step toward the start.
(4)	Move step (backward)	Moves the currently-selected program one step toward the end.
(5)	Save	When saving a new program: Switches to the cycle program save screen. When saving an existing cycle program that has been edited: The save program dialog box is displayed.
(6)	Save as ...	Switches to the cycle program save screen.
(7)	OK	Switches to the sewing operation screen.

- Select "Program No." in the add step screen and then touch the OK key to add that program number. The display will then return to the cycle program editing screen.
* If you touch the multiple select key (8), you can select multiple files.

[Add step screen]

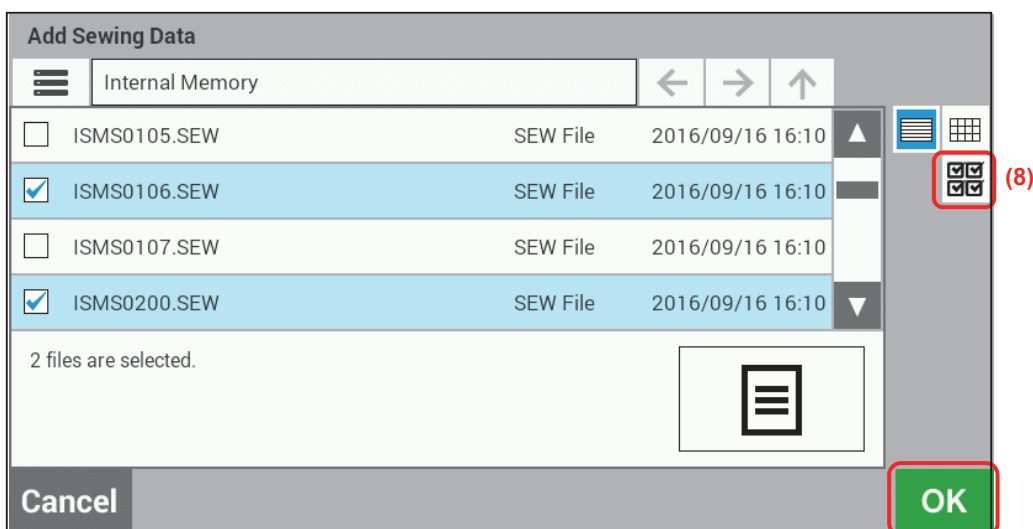

[Cycle program editing screen]

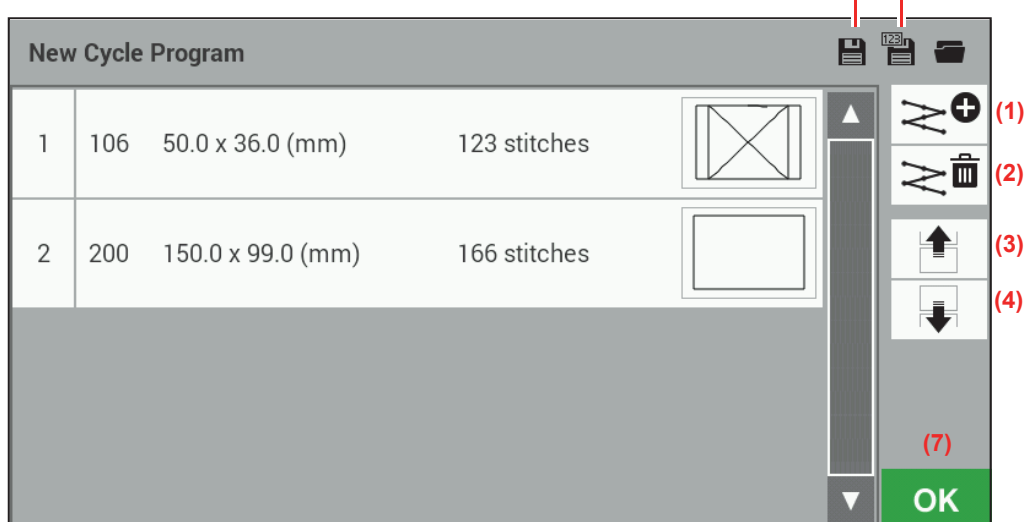

- Repeat the operations in steps 2. and 3. to create the desired cycle program, and then touch the Save key (5) or Save as ... key (6) to switch to the cycle program save screen.

[Cycle program editing screen]

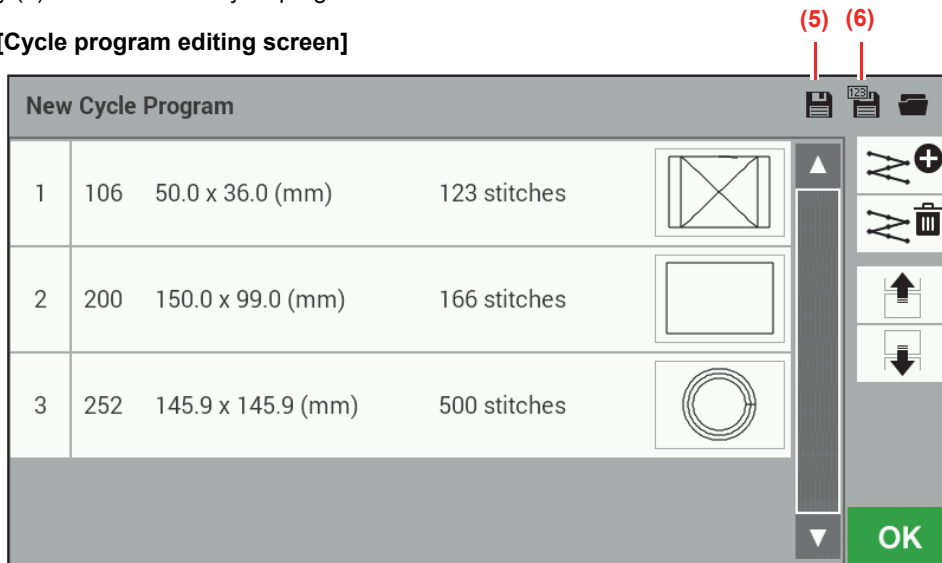

- Enter the cycle program number, and then touch the OK key. The cycle program will be saved and the display will return to the cycle program editing screen. Numbers from C01 to C30 can be saved.

[Cycle program save screen]

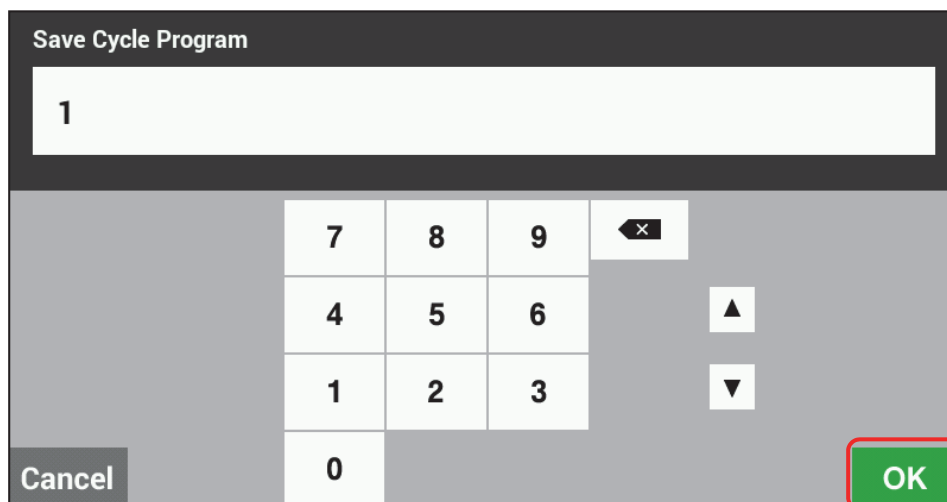

- Touch the OK key (7) in the cycle program editing screen to return to the sewing operation screen.

2. USING THE LCD PANEL (ADVANCED OPERATIONS)

<Method of use>

When cycle programs have been registered, you can select the cycle program numbers from the sewing operation screen.

[Sewing operation screen]

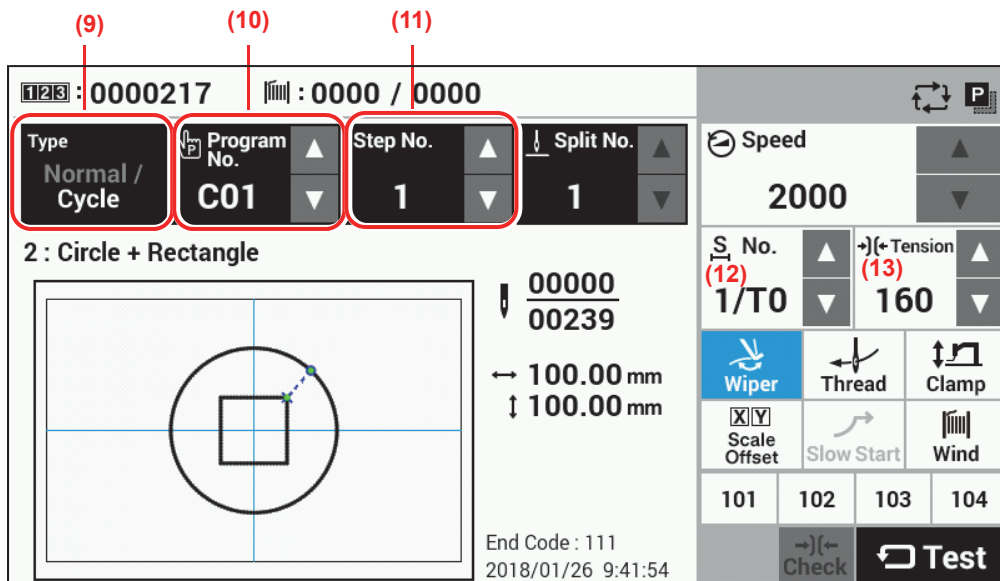

Descriptions of keys

(9)	Type key	Select "Cycle".
(10)	Program No. keys	The currently selected cycle program number is displayed. Touch the ∇/Δ keys to select the cycle program number that you would like to use.
(11)	Step No. keys	The currently selected step number is displayed. Touch the ∇/Δ keys to select the step number.
(12)	Section No. keys	The currently selected section number is displayed. Touch the ∇/Δ keys to select the section number.
(13)	Tension keys	The tension value of the currently selected section number is displayed. Touch the ∇/Δ keys to select the tension value.

2-4. Direct selection

You can use the direct selection keys to directly select program numbers and cycle program numbers.

[Sewing operation screen]

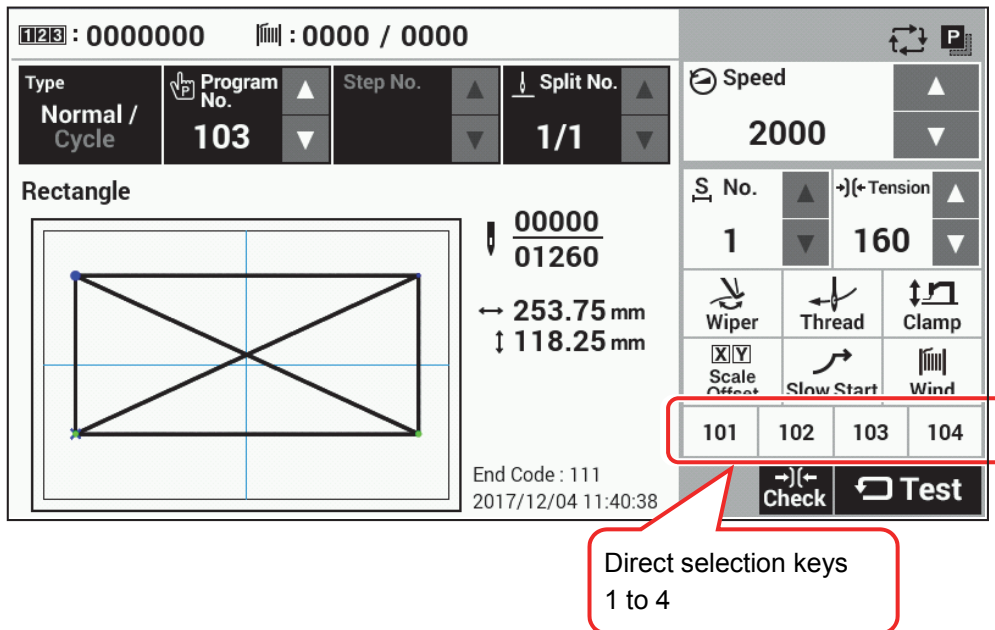

<Recording method>

This is carried out using memory switch Nos. 407 to 410.

Setting range: OFF, 001 - 999, C01 - C30

	Direct selection 1 key	Direct selection 2 key	Direct selection 3 key	Direct selection 4 key
Corresponding memory switch number	407	408	409	410
Initial value	101	102	103	104

- If there are no program numbers registered in a direct selection key (i.e. it is OFF), "---" will be displayed and the display will become inactive.
- If a program number (sewing pattern) which has been registered in a direct selection key cannot be loaded, the display will be inactive and the key cannot be selected.
- If you keep pressing a direct selection key, the display will switch to the settings for the program number displayed with this key.

2-5. Setting the sewing screen display

This lets you set whether the codes which are displayed in the sewing screen preview are displayed or not displayed.

1. Press the HOME key to switch to the home screen.
Touch the Settings key (1) to switch to the setting menu screen.

[Home screen]

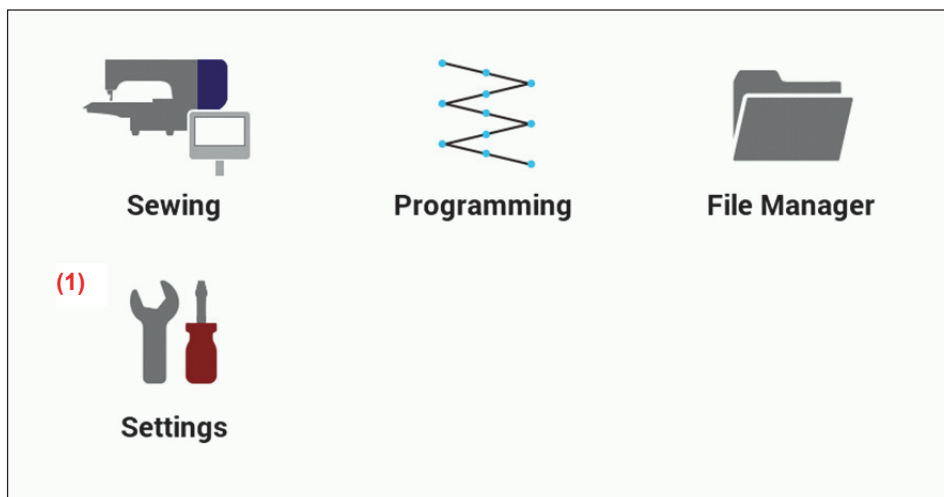

2. Select "Sewing Screen".

[Setting menu screen]

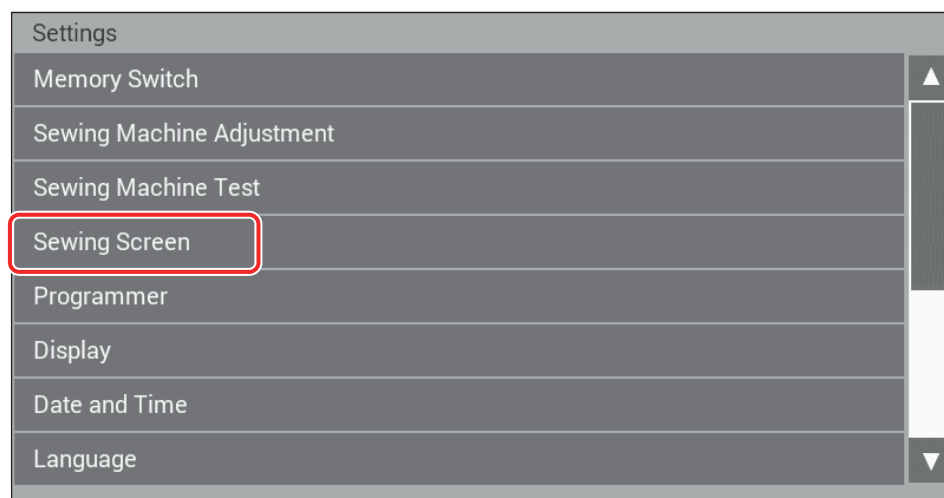

3. Select "Display Setting of Sewing Data Preview".

[Sewing Screen]

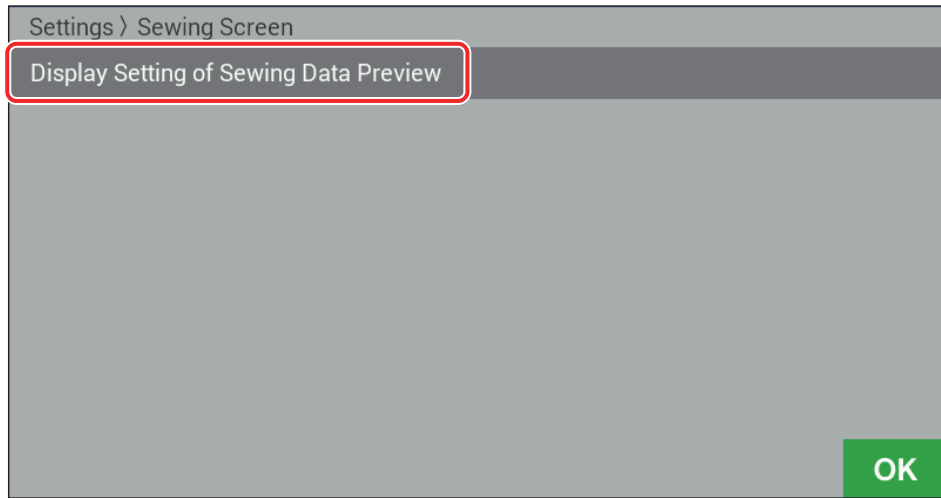

4. The codes which can be switched between displayed and not displayed in the sewing screen preview are displayed in a list.

If you would like the codes to be displayed, select the corresponding check box.

If you would like the codes to be not displayed, unselect the corresponding check box.

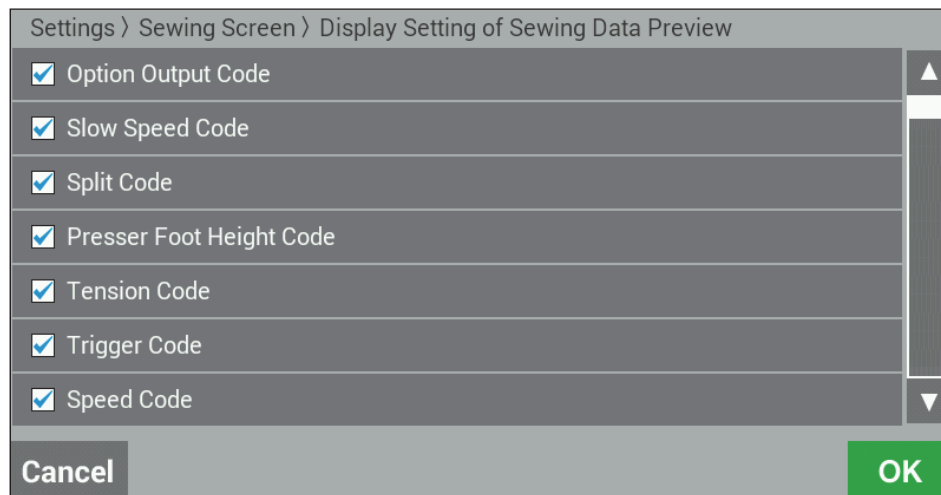
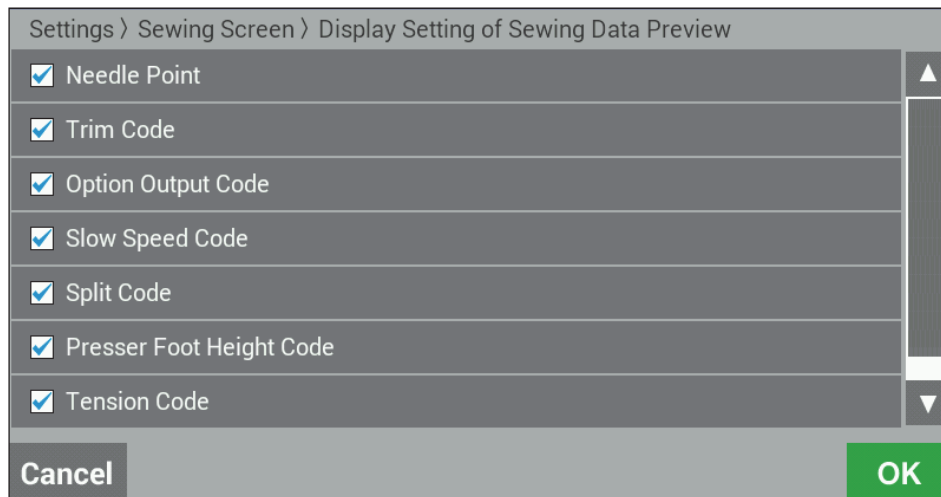

* These settings are not applied during tension checking mode.

2-6. Initialization method

Press the HOME key to switch to the home screen.

[Home screen]

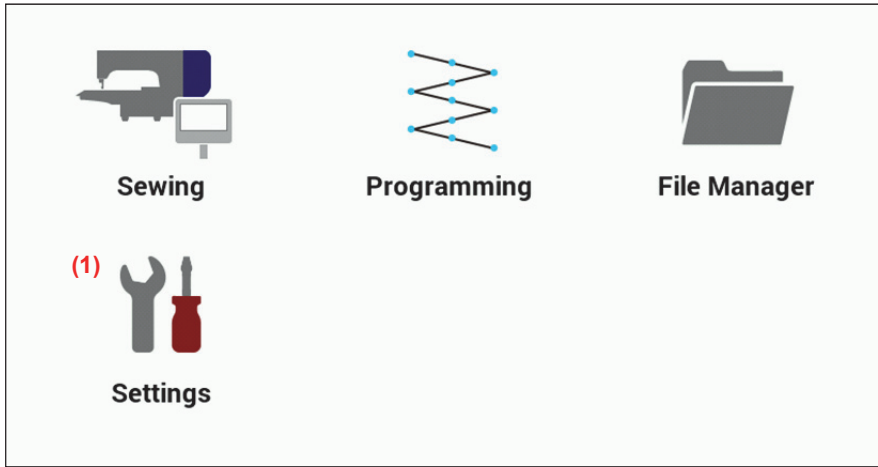

Touch the Settings key (1) to switch to the setting menu screen.

[Setting menu screen]

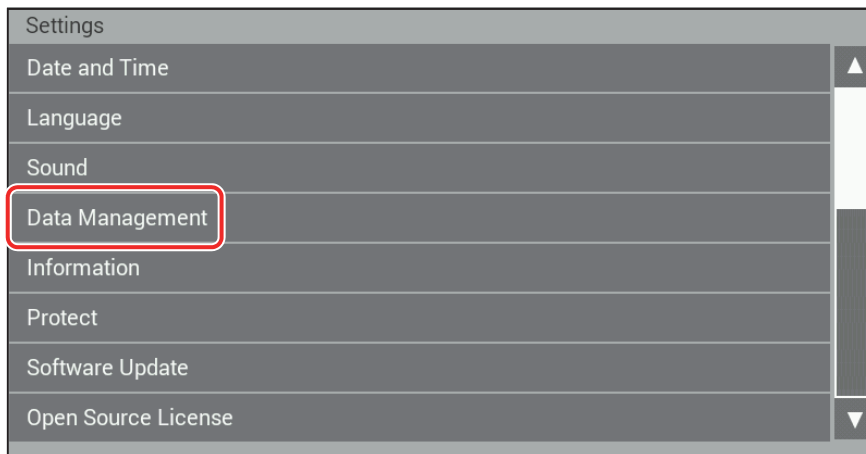

Select "Data Management".

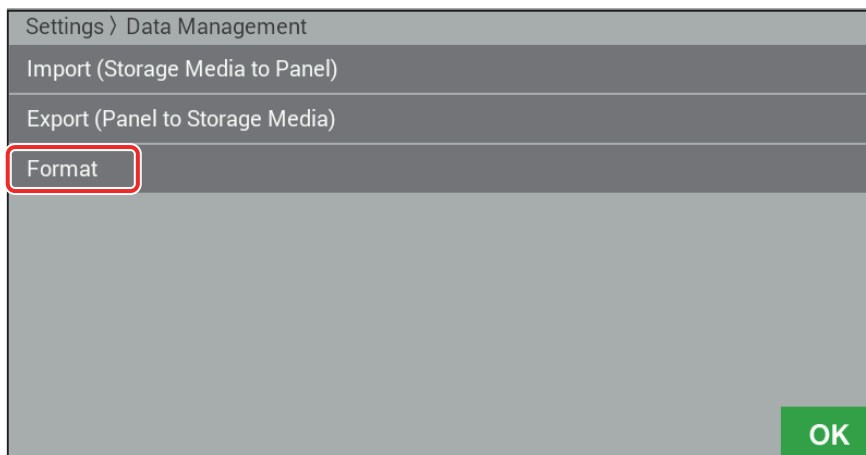

Select "Format".

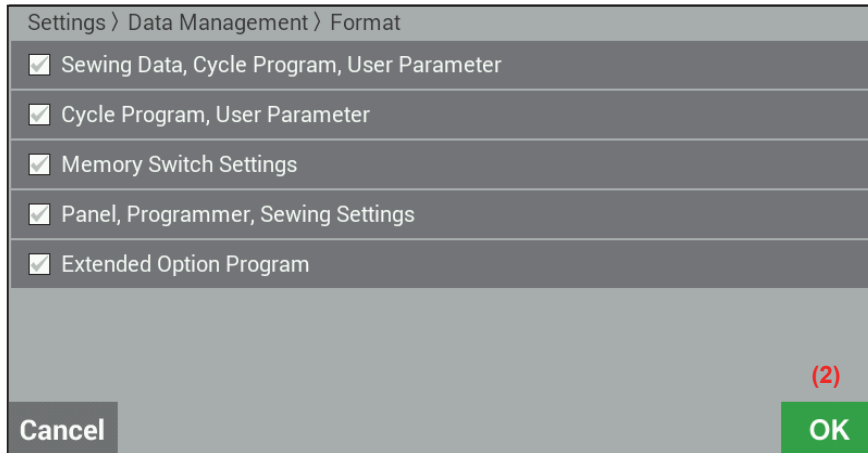

The following five items will be displayed for initialization.

- Sewing data, cycle program, user parameter
- Cycle program, user parameter
- Memory Switch Settings
- Panel settings, programmer settings, sewing settings
- Extended option program

Place a check mark against the items you would like to initialize, and then touch the OK key (2) to start the initialization.

When initialization is finished, the finished message screen will be displayed.

2-7. Maintenance mode

If you switch to maintenance mode, you can then move the needle bar base to the to the edge when carrying out adjustment, etc.

[Home screen]

Press the HOME key to switch to the home screen.

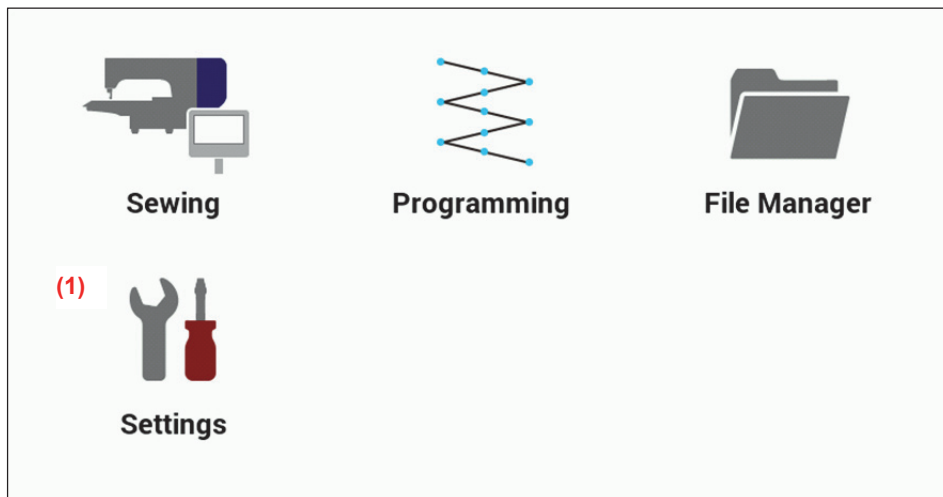

[Setting menu screen]

Select "Sewing Machine Adjustment".



[Sewing Machine Adjustment Screen]

Select "Maintenance".

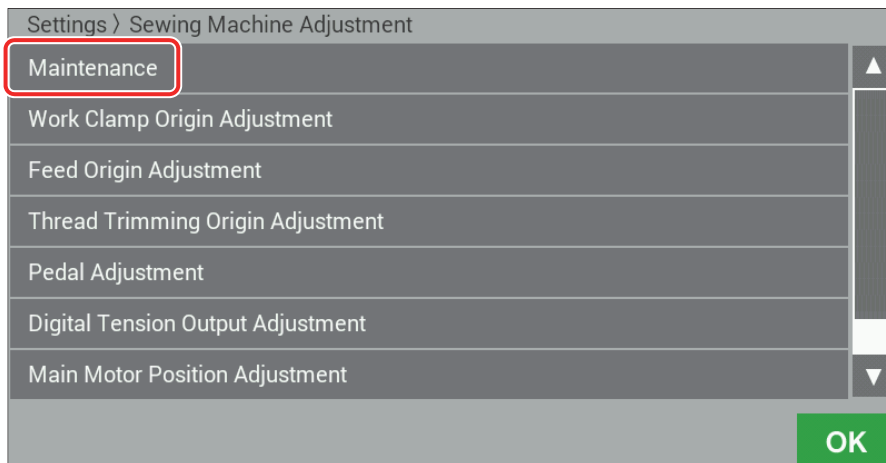

[Maintenance Screen]

[For BAS-360H and BAS-365H]

Press the left switch and the right switch simultaneously. The needle bar base will then move.

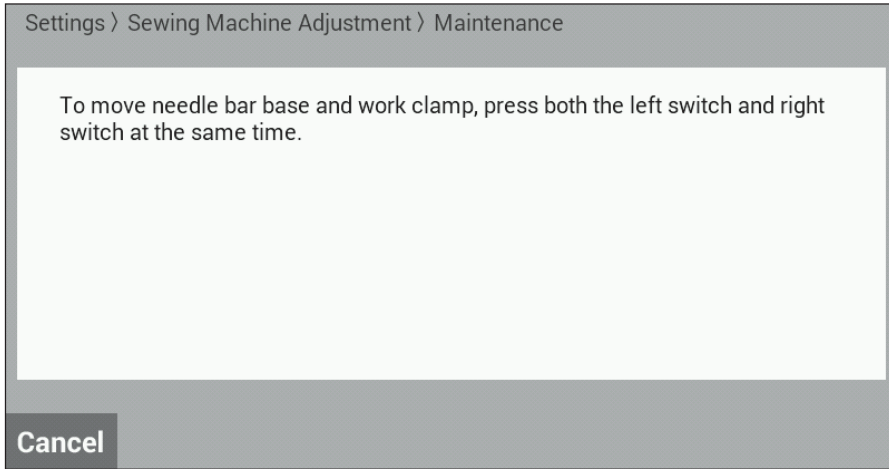

Remove both work clamp frame and feed plate, and turn off the power.

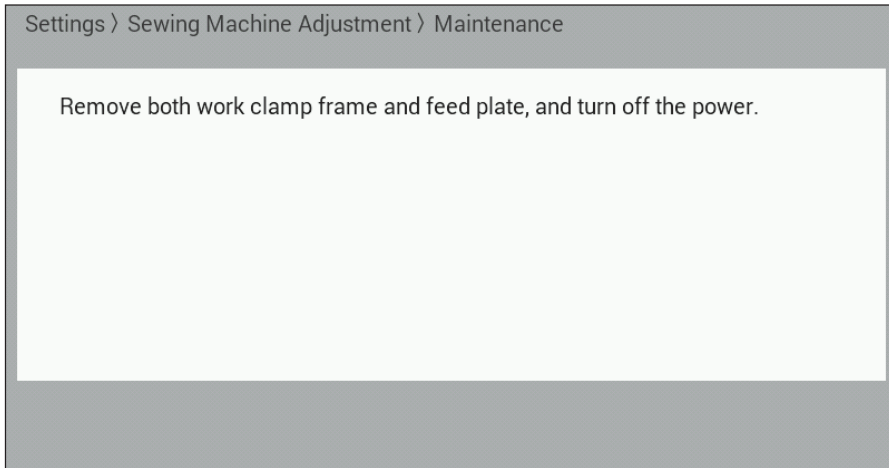

2. USING THE LCD PANEL (ADVANCED OPERATIONS)

[For BAS-370H and BAS-375H]

If the needle bar base is raised, press the right switch and the left switch simultaneously to lower the needle bar base. If you press the right switch and the left switch at the same time while the needle bar base is lowered, the needle bar base will rise and then move.

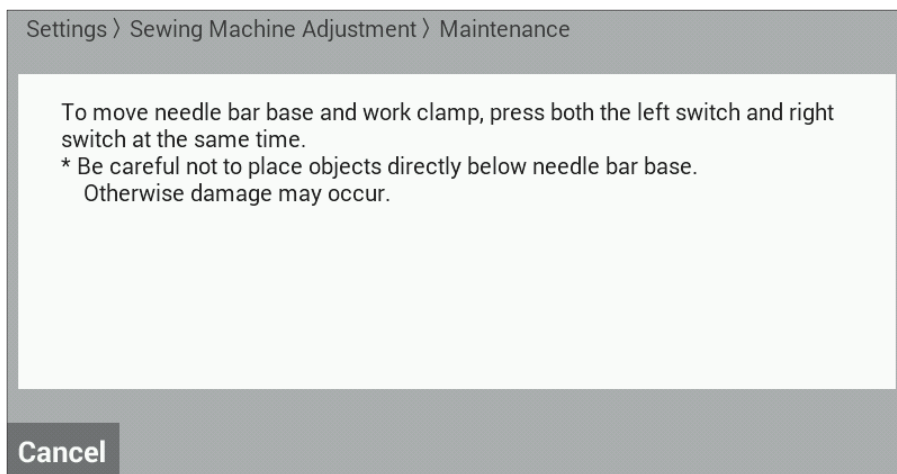

Press the right switch and the left switch simultaneously to lower the needle bar base, and then turn off the power.

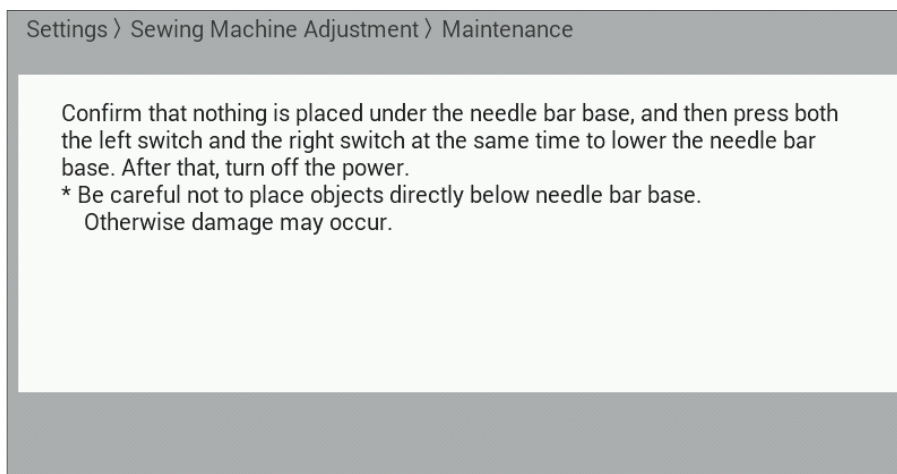

3. USING STORAGE MEDIA

CAUTION



Do not connect anything to the USB media other than the USB memory. If this is not observed, problems with operation may result.
To prevent problems, do not use objects with sharp points to operate the LCD panel.

3-1. Notes on handling

【SD】

- Compatible cards: SD (max. 2 GB), SDHC (max. 32 GB)
- Compatible file formats: FAT16, FAT32

【USB media】

- Compatible file formats: FAT16, FAT32
- Max. size: 32 GB

3-2. Folder structure

Data type	File name	Folder name
Sewing data	ISMS0***.SEW ISMS0***.EMB (*** is the program number.)	\BROTHER\ISM\ISMDH**\ \BROTHER\ISM\ISMDH**\ (For BAS-360H, BAS-365H, BAS-370H and BAS-375H) (The sewing machine's ID code appears in the ** part.) (Ask the place of purchase for details on the method of changing the settings.)
Memory switch	memorysw.db	Same as above
User parameter	userparam.db	Same as above
Cycle program	ISMICYC**.SEW (** is the cycle program number.)	Same as above
Panel setting values	settings.db	Same as above
Extended option data	ISMSEQ**.SEQ (** is the extended option number.)	Same as above
Error log	e*****.csv m*****.db (***** is the serial number.)	\BROTHER\ISM\ISMLDT\

3-3. Importing and exporting data

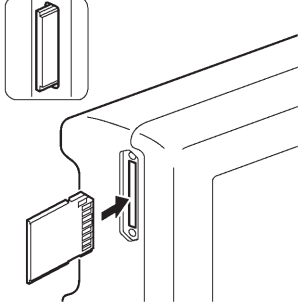
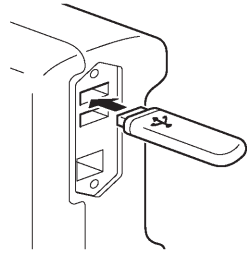
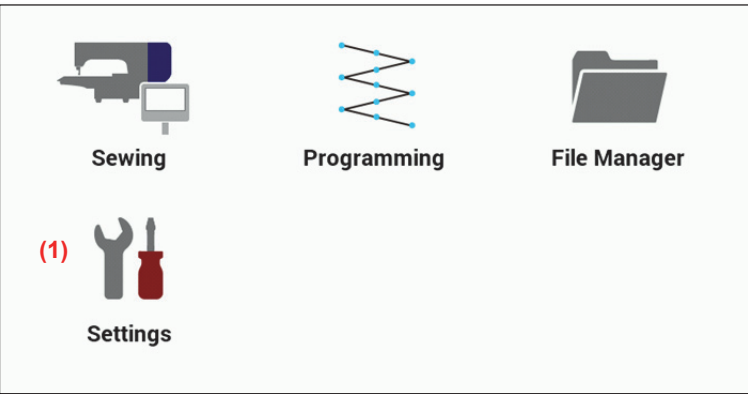
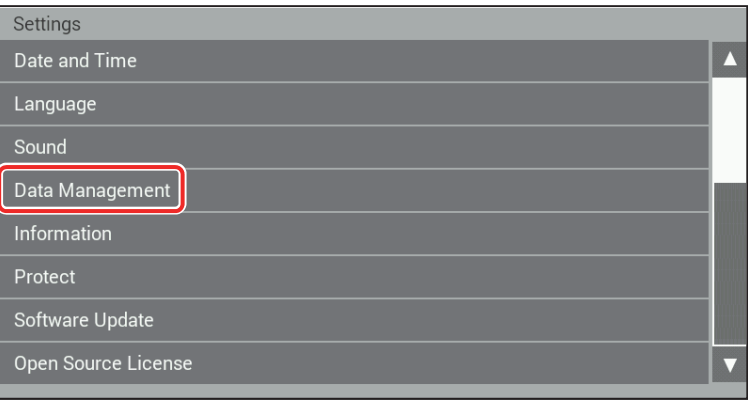
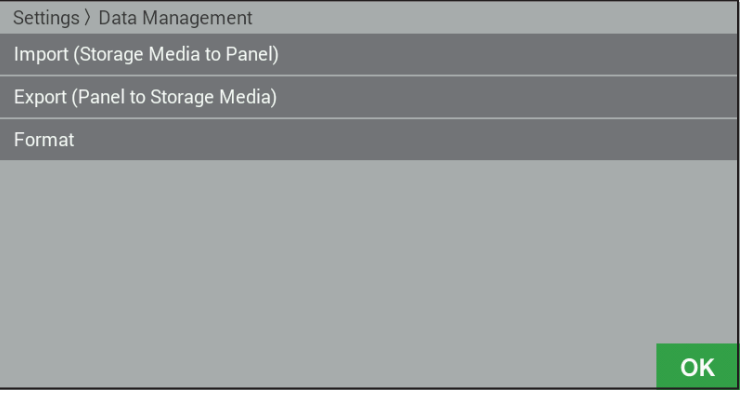
<p>1</p>	<div style="display: flex; justify-content: space-around;"> <div style="text-align: center;"> <p>SD card slot</p>  </div> <div style="text-align: center;"> <p>USB port</p>  </div> </div>	<p>Insert an SD card or USB media.</p> <p>NOTE:</p> <ul style="list-style-type: none"> • Make sure that the media is facing the correct way when inserting it. • Always be sure to keep the cover closed except when inserting and removing the media, otherwise dust may get inside and cause problems with operation. <p style="text-align: right;">4290B 3593B</p>
<p>2</p>	<p>[Home screen]</p>  <p>[Setting menu screen]</p>  <p style="text-align: center; font-size: 2em;">↓</p> 	<ul style="list-style-type: none"> • Press the HOME key to switch to the home screen. • Touch the Settings key (1) to switch to the setting menu screen. <ul style="list-style-type: none"> • If you select "Data Management" > "Import (Storage Media to Panel)", the display switches to the import screen. If you select "Data Management" > "Export (Panel to Storage Media)", it switches to the export screen.

3

[Import screen]

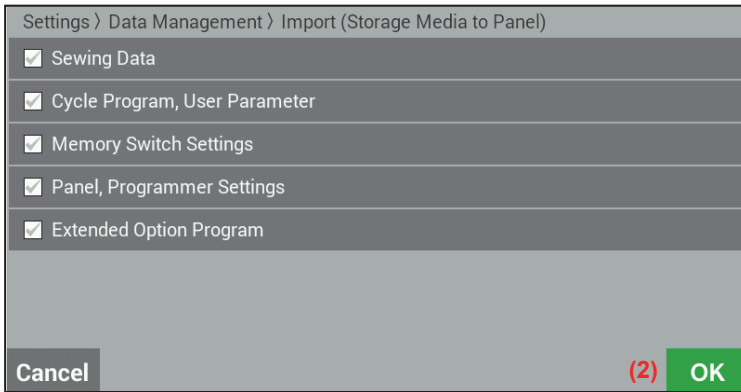

Select the items to be imported or exported, and then touch the OK key (2).

[Items to import]

Sewing data (all)
 Cycle program, user parameter
 Memory switch settings
 Panel settings, programmer settings
 Extended option program
 * To select and import only part of the sewing data, refer to the procedure in 3-4.

[Export screen]

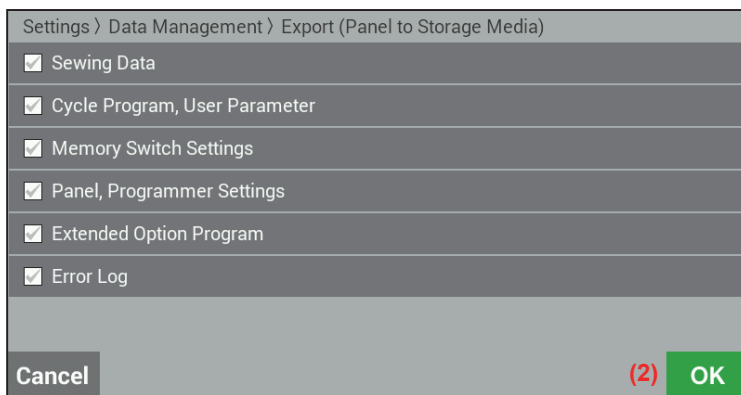



[Items to export]

Sewing data (all)
 Cycle program, user parameter
 Memory switch settings
 Panel settings, programmer settings
 Extended option program
 Error log

3-4. Importing items of sewing data separately

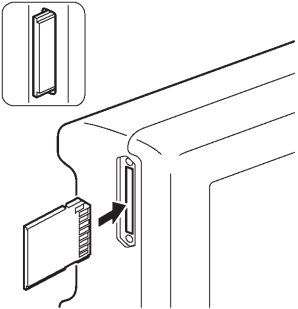
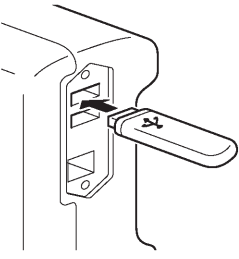
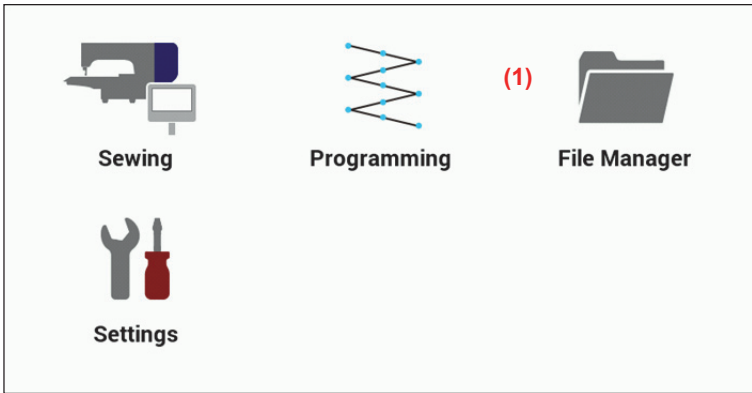
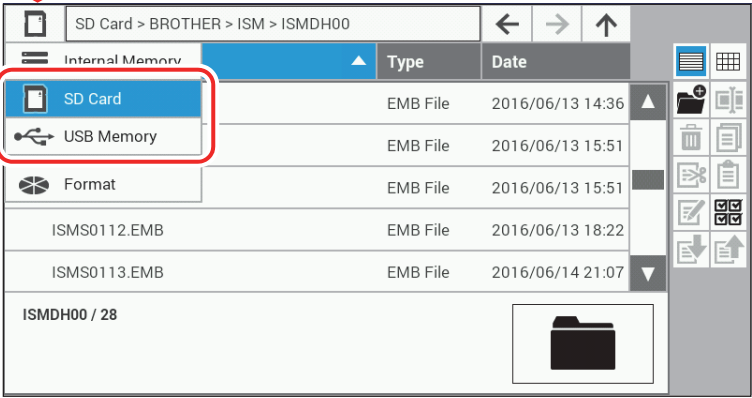
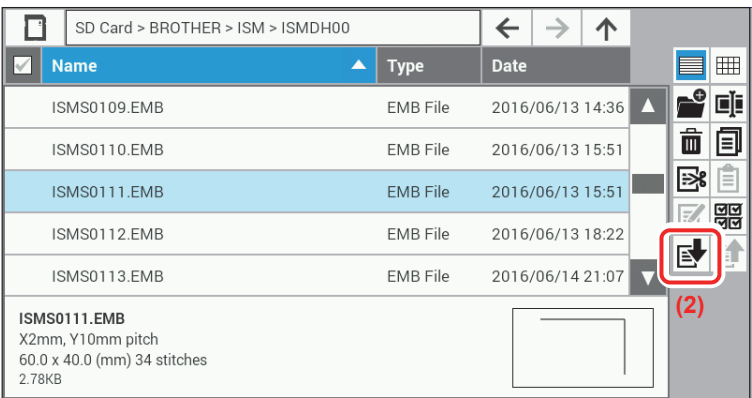
If you would like to import sewing data separately, do it from the file manager screen. Folders are not specified.

<p>1</p>	<div style="display: flex; justify-content: space-around;"> <div style="text-align: center;"> <p>SD card slot</p>  </div> <div style="text-align: center;"> <p>USB port</p>  </div> </div>	<p>Insert an SD card or USB media.</p> <p>NOTE:</p> <ul style="list-style-type: none"> • Make sure that the media is facing the correct way when inserting it. • Always be sure to keep the cover closed except when inserting and removing the media, otherwise dust may get inside and cause problems with operation. <p style="text-align: right;">4290B 3593B</p>
<p>2</p>	<p>[Home screen]</p>  <p>[File manager screen]</p> 	<ul style="list-style-type: none"> • Press the HOME key to switch to the home screen. • If you touch the File manager key (1), the display will switch to the file manager screen. • Touch the media key in the top-left corner to select "SD Card" or "USB Media". The display will switch to the respective main folder.
<p>3</p>		<ul style="list-style-type: none"> • Select the files to be imported and then touch the import key (2) . * If you would like to select multiple files, you can select files in multiple select mode.  Touch to switch between multiple select and single select mode.

* For details on other functions, please contact the place of purchase.

brother



INSTRUCTION MANUAL

* Please note that the contents of this manual may differ slightly from the actual product purchased as a result of product improvements.

BROTHER INDUSTRIES, LTD. <http://www.brother.com/>

1-5, Kitajizoyama, Noda-cho, Kariya 448-0803, Japan. Phone : 81-566-95-0088

© 2015, 2016, 2018, 2019 Brother Industries, Ltd. All Rights Reserved.

This is the original instructions.

BAS H series
I9031310B E
2019.03.B(1)